

JEEP®

A C C E S S O R I E S



Wrangler JK ♦ TJ ♦ YJ ♦ CJ ♦ Cherokee

California Carsmetics

1052 Brydges St.
London, Ontario
N5W 2B4

519-457-6004 Fax 519-457-6095

NEW

Look for this symbol inside for what's NEW!



Page 102
New Venom™
Fiberglass JK Hood



Page 47
New BR Series Modular Winch Bumpers
and RB10 Running Boards



Page 46
Vengeance Series Bumpers



Page 34, 37, 49, 54
New Fender Flares, Rock Rails, and
HDX® Bumpers



Page 84-85
Truck-Lite LED Headlights
Radiance and Midnight Edition LED Kits



Page 114
Accessories



Page 6
Suspension Systems



Page 44
JK Front and Rear Bumpers



Page 55
New 12K
Synthetic Winches



Page 108
Nighthawk Paint-match
Headlight Brow



Page 21
6112 and 8125 Series Shocks

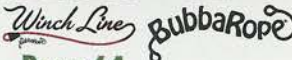

Page 64
Synthetic Replacement Winch Line
and Extensions



Page 11
Hydraulic Bump Stops



Page 22
Stealth Shock Absorbers



Page 114-115
Hot New Products



Page 16
15-16 Renegade Lift Kit



Page 77
C3 Cargo Covers



Page 126
Supercharger and Cylinder Head



Page 13
JKS MANUFACTURING
JSPEC™ Suspension Systems

Page 14
BP-51 Series Shock Absorbers



Page 141
Jeep® Replacement Parts



TERAFLEX SPORT S/T3

SUSPENSION SYSTEM

TeraFlex 3" Sport S/T3 Suspension System has been designed as a complete all-inclusive system and will deliver capability, performance and dependability. This kit combines the performance enhancements of the 3" lift kit, the maintenance free benefit of the Sport Flexarm, and proven progressive SpeedBump bumpstops for a complete suspension system. Install on Friday, wheel on Saturday, drive to church Sunday! The 3" Sport S/T3 Suspension System includes a 3" lift, SpeedBump bumpstops, front trackbar, and 6 sport flexarms. Pair this kit with TeraFlex tuned Fox 2.0 reservoir shocks for maximum performance.

TERAFLEX SPORT S/T4

LONG ARM SUSPENSION SYSTEM

The 4" Sport long arm suspension system continues where the 3" Sport Kit left off. It delivers long arm performance in the same maintenance free design. The 4" Sport long arm suspension system includes a 4" lift kit, front trackbar, rear trackbar, and all 8 sport long flexarms, limit straps and all required hardware. Pair this kit with TeraFlex tuned Fox 2.0 reservoir shocks for maximum performance.

TERAFLEX

SUSPENSION

Part No.	Application
1258250	JK 2-Door S/T3 System No Shocks
1258200	JK 2-Door S/T3 System Fox Shocks
1258450	JK 4-Door S/T3 System No Shocks
1258400	JK 4-Door S/T3 System Fox Shocks



Part No.	Application
4750832	JK 2-Door S/T4 System No Shocks
4750830	JK 4-Door S/T4 System No Shocks



07-15 Jeep® JK Wrangler 2/4 Door* 2.5" Performance Budget Boost



The budget boost is designed for JK owners who wish to lift their vehicle without any additional modifications. Will increase ground clearance and create room for larger tires. Our exclusive spring retention spacers that do not allow the spring to drop out during extreme articulation. Allows up to a 35" tire (aftermarket wheels with 4.5" backspacing or less are required).

- Part No. 1255200 - 2dr - JK 2.5" Budget Boost with 9550 Shocks
- Part No. 1355210 - JK 2.5" Budget Boost with Shock Extension - No Shocks
- Part No. 1355200 - JK 2.5" Budget Boost - No Shocks

07-15 Jeep® JK Wrangler 2/4 Door* 2.5" Suspension System



An ultra simple performance oriented lift kit, and includes a heavy duty axle mounted trackbar bracket. The basic lift includes all of the essential items needed (some form of shock modification will be required- either adapters or new longer shocks). Allows up to a 35" tire (aftermarket wheels with 4.5" backspacing or less are required).

Part No.	Application
1251002	2dr Kit with 9550 Shocks
1352002	2dr Kit with Shock Extensions - No Shocks
1351002	2dr Kit with No Shocks
1251000	4dr Kit with 9550 Shocks
1352000	4dr Kit with Shock Extensions - No Shocks
1351000	4dr Kit with No Shocks

07-15 Jeep® JK Wrangler 2/4 Door** JK 1.5" Spring Leveling Kit

Linear coil springs maintain highway handling characteristics and allow for increased off-road handling and articulation. Kit includes a 2" lift front spring, and a 1" lift rear spring with longer front swaybar links.

- Part No. 1351502 - JK 2dr 1.5" Spring
- Part No. 1351500 - JK 4dr 1.5" Spring



JK Front Forged Adjustable Trackbar Kit

This massive heavy duty forged front adjustable trackbar is designed as the ultimate in front end strength to eliminate any front end shimmy or handling issues. This Monster trackbar is 230% stronger than the factory trackbar. A complete bolt on component. Fits all vehicles stock to 6+" of lift.
Part No. 1753418



07-15 Jeep® JK Wrangler 2/4 Door** JK 1.5" Leveling Kit

Kit includes a 2" front spacer, and a 1" rear spacer with longer front swaybar links. Fits all JK Wranglers including Rubicon and Unlimited.
Part No. 1155200 - JK 1.5" Leveling Kit



* Note: Driveline modifications are required on all JK Wranglers and Unlimiteds with this suspension system. 2012+ JKs require exhaust spacers (Part No. 2610000) or other exhaust modification for proper driveline clearance. **This kit does not include extended bumpstops. If larger tires are used some rubbing will occur during suspension compression.



Max-Flex 4.0" - 4.5" Off-Road Suspension System 07-16 Jeep® JK Wrangler 2/4 Door

The heart of the system is the development of beefy 1-3/4" - 5/16" DOM tube steel front and rear control arms which have been teamed with the absolute best and strongest flex joints on the market - the Currie Original Johnny Joint®. No other joint on the market can compare when it comes to getting Maximum Articulation. The 4.5" of front lift and 3.5" of rear lift is achieved with ReadyLIFT® progressive wound Off Road coil springs. This lift includes heavy duty extended length front and rear sway bar end links that do not compromise on road handling nor maximum flexing qualities. Includes new heavy duty front track bar with Johnny Joints®.

- Bolt on installation - no modifications required
- Tough silver and black powdercoated finish
- Includes Original Currie Johnny Joints® - fully servicable with a tough zinc plated finish
- 4 Door - 4.0" Front lift - 3.0" Rear lift - progressive wound coil springs
- 2 Door - 4.5" Front lift - 3.5" Rear lift - progressive wound coil springs
- Provides maximum articulation - no binding or limitations even in the most extreme flexing situations
- 1-3/4"-5/16" Heavy duty dom tube steel control arms
- Includes 3/16" plate steel rear track bar bracket to correct roll center and bushing alignment.
- Fits 2dr and 4dr Wranglers including Unlimited and Rubicon
- Allows for up to 38" tires with 4.5" Backspacing wheels or less when using flat fenders

Recommend ReadyLIFT® 776002 / 776003 Heavy Duty Off Road Track Bars - Includes Johnny Joints® (bars sold separately)

- Part No. 496407** - 4dr - 4.0" JK MAXFLEX, 8-Arm Kit, Without Shocks
- Part No. 496411** - 4dr - 4.0" JK MAXFLEX, With HD Track Bar, 8-Arm Kit
- Part No. 496433** - 4dr - 4.0" JK MAXFLEX, With HD Track Bar, 8-Arm Kit, SST3000 Shocks
- Part No. 496406** - 2dr - 4.5" JK MAXFLEX, 8-Arm Kit, Without Shocks
- Part No. 496410** - 2dr - 4.5" JK MAXFLEX, With HD Track Bar, 8-Arm Kit
- Part No. 496432** - 2dr - 4.5" JK MAXFLEX, With HD Track Bar, 8-Arm Kit, SST3000 Shocks



Super Flex 4.0" - 4.5" 8-Arm Off-Road Suspension System 07-16 Jeep® JK Wrangler 2/4 Door

- Includes new heavy duty front track bar with Johnny Joints®
- Bolt on installation - no modifications required
- Includes original Currie Johnny Joints® - fully servicable with a tough zinc plated finish
- Includes new patent pending TCT - Terrain Control Technology Flex Joints
- Provides maximum articulation - no binding or limitations even in the most extreme flexing situations
- Allows for up to 38" Tires with 4.5" backspacing wheels or less when using flat fenders.

- Part No. 496611** - 4dr - 4.0" JK Super Flex, With HD Track Bar, 8-Arm Kit
- Part No. 496633** - 4dr - 4.0" JK Super Flex, With HD Track Bar, 8-Arm Kit - SST3000 Shocks
- Part No. 496610** - 2dr - 4.5" JK Super Flex, With HD Track Bar, 8-Arm Kit
- Part No. 496632** - 2dr - 4.5" JK Super Flex, With HD Track Bar, 8-Arm Kit - SST3000 Shocks



Advanced Jeep® JK Track Bar Kits

Our standard front and rear track bars are a substantial improvement over the OEM track bars and provide the much needed adjustability to work with lift kits. Our Heavy-Duty line of track bars are a beefed up version of our stock track bars. The 776002/776003 HD track bars feature 1.375" DOM tube steel construction, welded thread bungs and our Original Currie Johnny Joints® to provide maximum durability and off road performance even under the most extreme conditions. All of the ReadyLIFT® Track Bars are fully adjustable.



Part No. 676438

- Part No. 776000** - 07-16 Jeep® JK Wrangler - budget rear track bar
- Part No. 776001** - 07-16 Jeep® JK Wrangler - budget front track bar
- Part No. 776002** - 07-16 Jeep® JK Wrangler - heavy duty front track bar
- Part No. 776003** - 07-16 Jeep® JK Wrangler - heavy duty rear track bar
- Part No. 676438** - 07-16 Jeep® JK Wrangler - rear track bar bracket

Front High Steer Kit 07-15 Jeep® JK Wrangler



Brings your lifted Jeep® JK steering geometry back into factory alignment while improving steering precision and handling. This system corrects the roll center height of the front suspension. Reduces body roll, bump steer and roll steer. For use on 3.0" - 4.0" of lift

Part No. 776800



4.0" SST® Lift Kit System 07-16 Jeep® JK Wrangler

The ReadyLIFT® 696400 offers (4) Progressive Wound Coils to ensure unsurpassed On-Road mannersisms as well as increased Off-Road capability. This Kit includes (4) Replacement front and rear sway bar end links, rear track bar relocation bracket, new bump stops and bump stop pads to ensure the correct articulation of your suspension. The ReadyLIFT® 696400 kit includes shock extensions front and rear to accommodate your factory shocks and ensure the factory ride of the vehicle as the factory designed.



3.0" SST® Lift Kit System 07-16 Jeep® JK Wrangler

The ReadyLIFT 696000 SST Lift Kit will raise the 07-15 Jeep® JK Wrangler 3.0" in front and 2.0" in the rear. This kit retains the OEM springs and shocks while providing our popular coil spring spacer technology into this comprehensive package that will allow for up to 35" tall off road tires. The 696000 kit also includes a track bar relocation bracket, shock extensions, bump stop extensions, alignment cam bolts and all necessary hardware.



Part No. 696000 – 07-15 Jeep® JK Wrangler - SST Lift Kit

The ReadyLIFT® 4.0" SST® Lift Kit lifts your Jeep® JK Wrangler 4.0" in front and 3.0" in the rear for a lifted and level stance suitable for installation of 35" tall off road tires. With the use of "flat fenders" you can install 37" tall tires. This kit allows you to confidently take your Jeep® anywhere you want, on or off road, without sacrificing a quality ride or handling characteristics. The increased ground clearance provides many more off road opportunities than with a stock suspension along with the ability to install larger wheels and tires for the truly great lifted off road appearance!

Recommend using ReadyLIFT 776000 and 776000 front and rear track bars.

Part No. 696400 - 07-15 Jeep® JK Wrangler - SST Lift Kit



Max-Flex Short Arm Suspension System 07-16 Jeep® JK Wrangler 2/4 Door

- Tough silver and black powder coated finish
- Provides maximum articulation - no binding or limitations even in the most extreme flexing situations
- Fits 2 door and 4 door wranglers including Unlimited and Rubicon
- Includes original Currie Johnny Joints® - fully serviceable with a tough zinc plated finish
- Bolt on installation - no modifications required



Super-Flex Also Available



Part No.	Description
446500	Complete kit - 8 arms
446501	Front kit - 4 arms
446502	Rear kit - 4 arms
446510	Front upper kit - 2 arms
446511	Front lower kit - 2 arms
446520	Rear upper kit - 2 arms
446521	Rear lower kit - 2 arms

SST 3000

Black Performance Tuned Shocks



- Premium steel body performance shock
- Clear anodized corrosion resistant coated bodies
- Cnc precision machined body and end mounts
- Gas/oil separated, eliminates cavitation. 5/8" hard chrome plated shaft
- Rebuildable and revalvable. Two-stage sealing system-dirt out, oil in
- Nitrogen charged internal chamber. Designed for use on leveled and mild lifted vehicles
- Developed for use with larger oversized wheels and tires. Premium Lucas synthetic oil to insure maximum performance

Part No. 936400F - 07-16 Jeep® JK Wrangler Front - 2.5" - 4.0" Lift
Part No. 936400R - 07-16 Jeep® JK Wrangler Rear - 2.5" - 3.0" Lift

SST SHOCKS

SST 9000

SST9000 Shocks

- 100% premium satin finish billet aluminum
- CNC precision machined body and end mounts
- Two-stage sealing system; dirt out, oil in
- 5/8" hard chrome plated shaft
- Rebuildable and revalvable
- Nitrogen charged internal chamber
- Premium Lucas synthetic oil

Part No.	Lift Height Application
996400F	4.0" 07-16 Jeep® JK Wrangler, Front
996400R	3.0" 07-16 Jeep® JK Wrangler, Rear



09-16 Jeep® JK 3" Trail System

- Front and rear coil springs for superior ride and damping
- Four adjustable lower link arms for dialing in caster and driveline angle
- Links are built of 1/4" thick wall steel for maximum dent resistance with rotational joints for suspension flexibility
- Front replacement trac bar bracket eliminates the weak factory unit and recenters axle under vehicle
- Dropped pitman arm reduces bump steer with new the trac bar angle
- Front and rear bump stop spacers utilizes the factory closed cell bump stops for a cushioned impact
- Rear trac bar bracket keeps rear axle in line with front for better on road driving
- Front and rear extended sway bar links for new ride height
- Four fabtech performance shocks designed for maximum travel
- Allows use of 35" tall tires on 5" backspace wheels



Available Exclusively
Through This Catalog!



3" Trail Systems

Part No. KAOJKLIFT2 - 09-14 JK 2 door
Part No. KAOJKLIFT4 - 09-14 JK 4 door

12-16 Jeep® JK 5" Crawler System with Performance Shocks

For JK owners that require the ultimate in off-road performance Fabtech offers a 5" Crawler system that will allow use of 37" tall tires for aggressive offroad use. The front system features a conversion from the factory 4 link arms to our proven Radius Arm design. The adjustable Radius Arm links are constructed of 5/16" thick steel for maximum dent resistance with rotational urethane joints at each end for unrestricted articulation. These new Radius Arms mount to a 1/4" thick steel crossmember that bolts to the frame under the transmission. The front steering geometry is relocated via a dropped pitman arm. A Trac Bar relocation bracket keeps the arc of travel between the Trac Bar and Drag Link proper to reduce bump steer throughout the suspension travel. Lift is accomplished with replacement coil springs or a Coilover Conversion system with Dirt Logic 2.5 Coilovers for maximum performance both on and offroad. The rear system retains the factory 5 Link design but with extended length lower tubular arms that bolt to new side frame brackets. Installation of these frame brackets does not require the removal of the gas tank or welding. The upper links are replaced as well with a tubular style in the factory mounts. Both upper and lower links feature 5/16" thick wall links with adjustable rotational urethane ends. The rear Trac Bar is properly relocated to keep the rear axle tracking with the front axle for superior road handling at high speed.

Exhaust modification required on 2012 and newer models, or order FTS94060 Loop Delete Pipe.



Use 37/12.50R17 tires with 17x8.5 wheels
with 5" BS with minor trimming

Part No.	Description	Qty.
FTS24094	Component box 1	1
FTS24084BK	Component box 2	1
FTS24085BK	Coil box kit	1
FTS7188	Front performance shocks	2
FTS6002	Rear performance monotube shocks	2

Must order all components for a complete system.

*Order Required Accessories

Part No.	Description	Qty.
FTS94057	Front driveshaft 2 and 4 door models	1
FTS94058	Rear driveshaft 2 door model only	1
FTS94059	Rear driveshaft 4 door model only	1

*Kit Price does not include Drive Shafts
Must order all components for a complete system.



07-16 Jeep® JK 5" Short Arm System with Performance Shocks

Utilizing the factory link arm mounts Fabtech offers a 5" Short Arm system that features heavy wall 5/16" thick links with rotational urethane ends for unrestricted movement. These heavy-duty links feature adjustable ends to dial in caster and pinion angles. Lift is accomplished with replacement coil springs that have a slightly higher spring rate over factory while retaining flexibility for off-road use. Fabtech offers heavy duty replacement driveshafts to be used with this system for maximum driveline reliability. Extended length bump stop brackets, sway bar links and brake line brackets finish off this excellent performing system.

Exhaust modification required on 2012 and newer models, or order FTS94060 Loop Delete Pipe.



Use 37/12.50R17 tires with 17x8.5 wheels
with 5" BS with minor trimming

Part No.	Description	Qty.
FTS24081BK	Component box	1
FTS24085BK	Coil spring box	1
FTS7188	Performance front shock	2
FTS6002	Performance monotube rear shocks	2

Must order all components for a complete system.

*Order Required Driveshafts

Part No.	Description	Qty.
FTS94057	07-14 Front driveshaft 2 and 4 door models	1
FTS94051	07-11 Rear driveshaft 2 door model only	1
FTS94052	07-11 Rear driveshaft 4 door model only	1
FTS94058	12-14 Rear driveshaft 2 door model only	1
FTS94059	12-14 Rear driveshaft 4 door model only	1

*Kit does not include Drive Shafts.





07-16 Jeep® JK 3" Budget Systems

Includes four american made coil springs that have been designed to clear 35" tall tires. The coil springs are specific to 2 or 4 door models and undergo a "preset" manufacturing process to insure a consistent ride height. System also includes front and rear shocks, front sway bar links, front bump stops, rear bump stop extensions, rear trac bar bracket, rear brake hose extension bracket, emergency brake cable brackets all in one box. This system will increase offroad capabilities and provide a good highway ride.

Part No. FTS24095 - with Performance Shocks 2-Door 4WD

Part No. FTS24107 - with Dirt Logic Shocks - 2-Door 4WD

Part No. FTS24097 - with Performance Shocks 4-Door 4WD

Part No. FTS24108 - with Dirt Logic Shocks - 4-Door 4WD

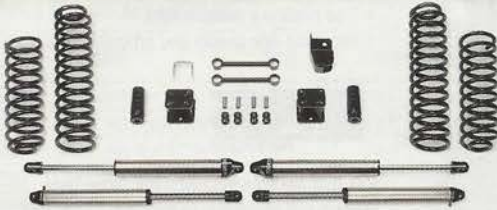

97-06 Jeep® Wrangler TJ

6" Long Arm with Front and Rear Coil Springs and Performance Shocks

Our TJ Long Arm systems redefines what a heavy-duty articulating Jeep® system should be. We have eliminated using the stock link pockets all together so that the upper and lower link can function on the same equal plane. Combine this equal plane geometry with extended length link arms and our rotational urethane pivot joints and you have a TJ system that will climb, crawl and walk over just about anything you put in front of it.



Use 35/12.50R15 tires with 15x8 wheels with 3-3/4" BS with minor trimming

03-06 Wrangler TJ		
Part No.	Description	Qty.
FTS24002BK	Component box 1	1
FTS24005BK	Component box 2	1
FTS44002BK	Coil spring box front and rear	1
FTS7174	Performance front shocks	2
FTS6002	Performance rear monotube shocks	2

Must order all components for a complete system.

04-06 LJ 6"-8" Crawler System Also Available

97-02 Wrangler TJ		
Part No.	Description	Qty.
FTS24002BK	Component box 1	1
FTS24003BK	Component box 2	1
FTS44002BK	Coil spring box front and rear	1
FTS7174	Performance front shocks	2
FTS6002	Performance rear monotube shocks	2

Must order all components for a complete system.



97-06 Jeep® Wrangler TJ / LJ

4" Performance System with Performance Shocks

Our 4" Performance system features four heavy wall tubular lower link arms with rotational urethane pivot assemblies on each end that provides articulation like a heim end but without the noisy highway ride. For maximum articulation add the optional upper links.

Use 33/12.50R15 tires with 15x7 wheels with 3-3/4" BS with minor trimming



Part No.	Description	Qty.
FTS24001BK	Component box 1	1
FTS44001BK	Component box 2	1
FTS7172	Performance front shocks	2
FTS6001	Performance Rear monotube shocks	2

Must order all components for a complete rear system.



Technically Superior Jeep® Suspension Systems

- Fully bolt-on
- Baja race proven
- Innovative designs
- True hardcore performance
- Improved ride quality and articulation



Kits that are equipped with our Silent Ride System run absolutely NOISE FREE. They use velvet smooth torsion natural rubber that NEVER require any kind of lubrication. SRS equipped kits also feature Hi-End cromoly/kevlar lined Heim Joints that allow massive amounts of articulation movement that also never require any kind of lubrication service. What you get is the only system that is truly and completely maintenance free.

Economy



16-3" and 4" Basic JK and TJ Kits



The CRC Link - The most innovative Jeep® handling accessory in the industry. True and correct handling for both Long and Short Arm kits.

Ultimate Short Arm



3", 4" JK, TJ, XJ and ZJ Ultimate Kits

TJ 4-Link Long Arm



6-3", 4" and 6" TJ Long Arm Kits

JK 4-Link Long Arm



4-3", 4" and 6" JK Long Arm Kits

Builder Components



Track Bars, Control Arms, Springs

PRO COMP

07-16 JK Wrangler, Rubicon and Unlimited 2.5" JK Tuned Suspension System

These easy to install systems feature tuned front and rear coil springs, exclusive heavy duty rear track bar brace, and high quality hardware to improve the vehicle's ride and handling over all road surfaces. Available with either MX-6 adjustable shocks for superior flexibility and off-road handling or ES9000 shocks for a factory ride quality. Allows use of 35" x 12.50" tires, on wheels up to 9" wide with up to 4.75" of backspacing.



Part No. K3099B
(ES9000 shocks)

Part No.	Application
K3099B	2.5" Lift With ES9000 Shocks
K3099BMX	2.5" Lift With MX-6 Shocks

07-16 JK Wrangler, 2/4-Door 3.5" Suspension System

Designed to provide a great ride on-road while letting you play off-road as well. Kits feature both front and rear adjustable chromoly track bars with Heim joints to allow you to center your axle and flex without binding. The coil springs are tuned perfectly with our top-of-the-line Pro Runner or ES9000 shocks and sit tall enough to easily clear 35" tires. Brake line brackets are included. Pro Comp's exhaust spacer kits and shocks are also available separately.



Part No. K3100B - JK 4-Door Gas with Front/Rear ES9000 Shocks
Part No. K3102B - JK 2-Door Gas with Front/Rear ES9000 Shocks

Includes front and rear replacement track bars.



5 YEAR
60,000 MILE
POWERTRAIN WARRANTY



For Use With Stock Arms 07-15 Jeep' JK Wrangler 4" JK Wrangler - Stage I Suspension with Rear Coils



Affordable suspension systems that deliver high end performance. Stage I systems feature option of MX-6 adjustable front and rear shocks for outstanding ride comfort and handling, or ES9000 front and rear shock absorbers to deliver factory ride quality. Allows use of 35"x12.50" tires, on wheels up to 9" wide with up to 4.75" of backspacing.

Part No. K3089BMX
Stage I
(MX-6 Shocks)

Part No.	Application
K3089BMX	4" Lift With MX-6 Shocks (4 Door)
K3089B	4" Lift With ES9000 Shocks (4 Door)
K3086BMX	4" Lift With MX-6 Shocks (Non Rubicon 2 Door)
K3086B	4" Lift With ES9000 Shocks (Non Rubicon 2 Door)



03-06 TJ Wrangler 4" Lift Stage I Short Arm Kit

Part No.	Application
K3076B	Kit With ES Shocks
K3077BMX	Hard Top Kit With MX6 Shocks
K3078BMX	Soft Top Kit With MX6 Shocks
K3092BMX	Kit With MX6 Shocks (1, 2)
K3092B	With ES9000 Shocks (2)

Note: 1,2 Transfer Case Slip Yoke Eliminator and CV Style Rear Drive Shaft required

4" Lift Stage II Short Arm Kit 97-02 TJ Wrangler

Part No.	Application
Auto / 5 Spd Trans.	
K3083B	Kit With ES Shocks
K3083BMX	Kit With MX6 Shocks
Auto Trans.	
K3056B	Kit With ES Shocks
K3056BMX	Kit With MX6 Shocks



5 YEAR
60,000 MILE
POWERTRAIN WARRANTY

04-06 LJ Unlimited 4" Lift Stage I Short Arm Suspension Systems

Part No.	Application - Automatic/Manual Transmission
K3095BMX	4" Lift With MX-6 Shocks
K3084B	Kit With ES Shocks
K3084BMX	Kit With MX6 Shocks
K3083B	Kit With ES Shocks
K3083BMX	Kit With MX6 Shocks
K3095B	4" Lift With ES9000 Shocks (2)



97-02 TJ Wrangler 4" Lift Long Arm Suspension System

Part No.	Application - 5 Spd Manual Trans
K3088B	4" Lift With ES9000 Shocks (1)
K3088BMX	4" Lift With MX-6 Shocks
K3091B	4" Lift With ES9000 Shocks (1)
K3091BMX	4" Lift With MX-6 Shocks

Note: 1 Transfer Case Slip Yoke Eliminator and CV Style Rear Drive Shaft required

SKYJACKER® SUSPENSIONS



Value Flex Systems Available

07-16 Jeep® JK 3-4" Budget Lift Kits

Includes: shock extension brackets, front springs, rear springs, stabilizer bar links, bump stop extensions, brake line relocation bracket, hardware, instruction sheets. Does not require replacing shocks.

Part No. JK4DR4INCH - 4" lift, 4 door
Part No. JK2DR3INCH - 3" lift, 2 door

07-15 Wrangler JK/Rubicon 4-Door Only 2WD/4WD 2.5 Suspension Lift

Part No. JK25BPH - includes front and rear coil springs, and HYDRO shocks

07-15 Jeep® JK 4 Door 2.5" Suspension Lift

Part No.	Description	Qty.
JK25F	Front Coils	1
JK25R	Rear Coils	1
JK250B	Component Box	1
H7035	Front Hydro Shock	2
H7037	Rear Hydro Shock	2



Must Order All Components For A Complete Kit

07-16 Jeep® JK 4 Door 4" Standard System

Part No.	Description	Qty.
JK40BPH	Component Box	1
JA770	Pitman Arm	1

Note: Kit Includes Front and Rear Coil Springs, Front and Rear Track Bar Brace, Front and Rear Track Bar Bracket, Front and Rear Cam Bolts Instead of Lower Links, and Front and Rear Hydro Shocks

Must Order All Components For A Complete Kit



Rock Ready®
Systems Available

07-16 Jeep® JK 4 Door 4" Standard System

Part No.	Description	Qty.
JK40F	Front Coils	1
JK40R	Rear Coils	1
JK401	Component Box	1
JA770	Pitman Arm	1
H7065	Front Hydro Shock	2
H7067	Rear Hydro Shock	2

Note: Kit Includes Front and Rear Lower Links

Must Order All Components For A Complete Kit

07-15 Jeep® JK 2/4 Door 2" Poly Spacer Lift

Part No.	Description	Qty.
JK20	Component Box	1
H7035	Front Hydro Shock	2
H7037	Rear Hydro Shock	2



Must Order All Components For A Complete Kit



07-15 JK Wrangler Dual Steering Stabilizer

Part No. 7203 (White)
Part No. 9203 (Silver)

Note: Boots not included due to clearance issues



07-15 JK Wrangler Front and Rear Upper Adjustable Cam Bolts. Allows for 0-3° Caster / Pinion Angle Adjustment

Part No. CAM700 - 07-14 Jeep® JK Wrangler
Part No. CAM500 - 97-06 Jeep® TJ Wrangler
Part No. CAM500 - 93-98 Jeep® ZJ



07-15 JK Wrangler 2/4WD 3/4" Front Poly Spacers

Part No. JKFPS75

07-15 Jeep® JK 2/4 Door



4" Long Arm Kit

Part No.	Description	Qty.
JK40F	Front Coils	1
JK40R	Rear Coils	1
JK40LA	Component Box	1
JK46LASX	Component Box	1
JA770	Pitman Arm	1
H7065	Front Hydro Shock	2
H7067	Rear Hydro Shock	2

Must Order All Components For A Complete Kit

07-15 Jeep® JK 2/4 Door



6" Long Arm Kit

Part No.	Description	Qty.
JK60F	Front Coils	1
JK60R	Rear Coils	1
JK60LA	Component Box	1
JK46LASX	Component Box	1
JA770	Pitman Arm	1
H7075	Front Hydro Shock	2
H7087	Rear Hydro Shock	2

Must Order All Components For A Complete Kit

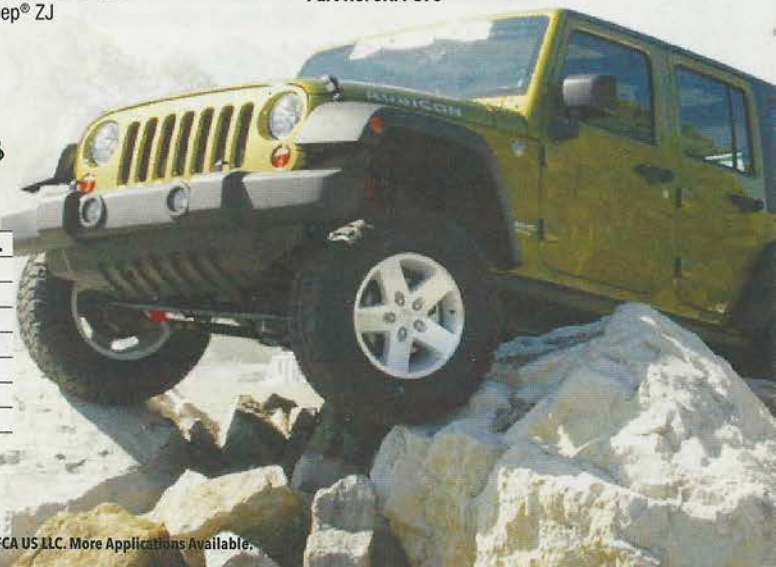

SKYJACKER® SUSPENSIONS



07-16 Jeep® Wrangler JK 2 Door 2"- 2.5" Softride Coil Spring Lift

Softride® coils are engineered to provide the feel of the original ride quality. These Softride® off-road able coils are the ideal choice where OEM ride quality and long lasting comfort is your peak concern. All Made in the USA Skyjacker coils are constructed using hot wound 5160 material and shot peened for tensile strength, then preset solid to allow full coil bind eliminating sagging. Kit includes: front and rear Softride coil springs, rear track bar bracket, front bump stop spacers, rear bump stop brackets, front and rear shocks.

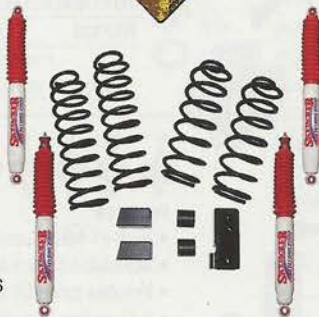

- Part No. JK350BPHSR - With Hydro 7000 Shocks
- Part No. JK350BPMSR - With M95 Monotube Shocks
- Part No. JK350BPNSR - With Nitro 8000 Shocks



07-16 Jeep Wrangler JK 4 Door 2"- 2.5" Softride Coil Spring Lift

Kit includes front and rear Softride coil springs, rear track bar bracket, rear track bar brace, front bump stop spacers, rear bump stop brackets, front and rear shocks.



- Part No. JK25BPHSR - With Hydro 7000 Shocks
- Part No. JK2500BPMSR - With M95 Monotube Shocks
- Part No. JK25BPNSR - With Nitro 8000 Shocks

Also Available in Rock Ready®

Rock Ready® coils are designed to handle the demanding needs of off-road performance while still providing comfort during daily driving. Rock Ready® coils make a great choice when additional weight of trail gear and accessories put your rig to the test.

07-16 Jeep Wrangler JK 2 Door 3.5" Softride Coil Spring Lift



Kit includes front and rear Softride coil springs, front and rear track bar bracket, front and rear track bar brace, front and rear cam bolts, front bump stop spacers, rear bump stop brackets, rear sway bar end links, rear brakeline brackets, front and rear shocks.

- Part No. JK350BPHSR - With Hydro 7000 Shocks
- Part No. JK350BPMSR - With M95 Monotube Shocks
- Part No. JK350BPNSR - With Nitro 8000 Shocks

07-16 Jeep Wrangler JK 4 Door 4" Softride Coil Spring Lift



Kit includes front and rear Softride coil springs, front and rear track bar bracket, front and rear track bar brace, front and rear cam bolts, front bump stop spacers, rear bump stop brackets, rear sway bar end links, rear brakeline brackets, front and rear shocks.

- Part No. JK40BPHSR - With Hydro 7000 Shocks
- Part No. JK400BPMSR - With M95 Monotube Shocks
- Part No. JK40BPNSR - With Nitro 8000 Shocks

JK Optional Accessories

Part No.	Application
7003	OEM Replacement Steering Stabilizer - White with Red boots
7203	Dual Steering Stabilizer - White with Red boots
9003	OEM Replacement Steering Stabilizer - Silver with Black boots
9203	Dual Steering Stabilizer - Silver with Black boots
JKFPS75	Front Coil Spring Isolator Pads 3/4", Pair
JKRPS75	Rear Coil Spring Isolator Pads 3/4", Pair

03-06 Jeep® TJ 4WD 4" Standard System

Part No.	Description	Qty.
TJ403BPH	Component Box	1

Note: Kit Includes Front and Rear Coil Springs, Front and Rear Lower Links, Rear Track Bar Bracket, Drop Pitman Arm, Transfer Case Lowering kit, Front and Rear Extended End Links, and Front and Rear Hydro Shocks

03-06 Jeep® TJ 4WD 4" Flex System

Part No.	Description	Qty.
TJ403BPHX	Component Box	1

Note: Kit Includes Front and Rear Hydro Shocks, Front and Rear Softride® Coil Springs, Lower Standard Links, Front Sway Bar End Links, Rear Sway Bar End Links, Transfer Case Lowering Kit, Bump Stops, Drop Pitman Arm

97-02 Jeep® TJ 4WD 4" Standard System

Part No.	Description	Qty.
TJ401BPH	Component Box	1

Note: Kit Includes Front and Rear Coil Springs, Front and Rear Lower Links, Rear Track Bar Bracket, Drop Pitman Arm, Transfer Case Lowering kit, Front and Rear Extended End Links, and Front and Rear Hydro Shocks

97-02 Jeep® TJ 4WD 4" Flex System

Part No.	Description	Qty.
TJ401BPHX	Component Box	1

Note: Kit Includes Front and Rear Hydro Shocks, Front and Rear Softride® Coil Springs, Lower Standard Links, Front Sway Bar End Links, Rear Sway Bar End Links, Transfer Case Lowering Kit, Bump Stops, Drop Pitman Arm



4" Lift



Features:

- Adjustable control arms with serviceable Super-Flex spherical ball joints
- No welding
- Designed for on- and off-road performance
- Includes tuned lift springs, stainless steel brakelines and MUCH more
- Front and rear CV drive shafts available
- 4.5" and 5.5" systems include chromoly draglink flip with 1-ton tie rods

**07-16 JK Wrangler
Extreme-Duty 4-Link Long Arm Suspension**

Features adjustable chromoly lower control arms that will stand up to anything you can drive over. With PT-MEG Super-Ride bushings and Super-Flex joints they are sure to provide superior handling while not limiting articulation. The kit's FULL WIDTH heavy-duty transmission crossmember allows for more durability and frame rigidity than the competition. This also allows for installation that is much easier than competitor's kits eliminating the need for welding. An optional robust belly pan, and CNC machine steering knuckle provide outstanding upgrades. Driveline modifications will be required. 12-14 vehicles with 3.6L V6 will require exhaust modification RE4531.

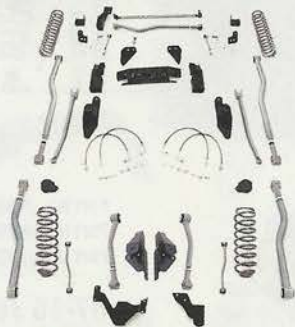

Part No. without shocks	Part No. with Mono	Application	Lift
JK4423	JK4423M	07-16 JK Wrangler 2DR	3.5"
JK4424	JK4424M	07-16 JK Wrangler 2DR	4.5"
JK4425	JK4425M	07-16 JK Wrangler 2DR	5.5"
JK4443	JK4443M	07-16 JK Wrangler 4DR	3.5"
JK4444	JK4444M	07-16 JK Wrangler 4DR	4.5"
JK4445	JK4445M	07-16 JK Wrangler 4DR	5.5"

Upgrades

Part No.	Application
RE7333	TO CONVERT FROM Extreme-duty Radius LONG ARM to 3-Link 07-16 JK Wrangler 2DR and 4DR

**07-16* Jeep® Wrangler JK
3.5"-4.5" Super-Flex™ Short Arm Suspension**

The Super-Flex short arm suspension systems are designed for JK owners looking for the best short arm suspension system on the market that retains the factory mounting locations. The 3.5" suspension will allow the use of 35" tires and the 4.5" suspension will allow the use of 37" tires.

**12-16 JK 3.5" Not using recommended RE shocks will require our CV Style driveshaft RE1883-365 and yoke RE1810.*

**12-16 JK 4.5" Requires our CV Style driveshaft RE1883-365 and yoke RE1810.*



Features:

- NEW PT-MEG Super-Ride bushings
- Adjustable control arms with serviceable Super-Flex spherical ball joints
- Includes tuned lift springs, stainless steel brake lines
- 4.5" system includes chromoly tie rod flip with 1-ton tie rods



Part No.	Application
RE7123	3.5" Super-Flex Short Arm System 2 Door
RE7124	4.5" Super-Flex Short Arm System 2 Door
RE7143	3.5" Super-Flex Short Arm System 4 Door
RE7144	4.5" Super-Flex Short Arm System 4 Door
RE7000	4.5" Super-Flex™ Suspension - 97-06, SYE/CV Driveline Required
RE7002	3.5" Standard Suspension - 97-06, SYE/CV Driveline Recommended + Cam bolts
RE7203	3.5" Extreme-Duty™ Long Arm System - 97-02, SYE/CV Driveline Required
RE7204	4.5" Extreme-Duty™ Long Arm System - 97-02, SYE/CV Driveline Required
RE7223	3.5" Unlimited Extreme-Duty Long Arm - 04-06

**07-16* Jeep® Wrangler JK
2"-3.5" Standard System**

The industry leading Standard system is a great performing, low-cost complete suspension system that retains the factory control arms. The 2" suspension will allow the use of 33" tires and the 3.5" suspension will allow the use of 35" tires.

**12-16 JK 3.5" Not using recommended RE shocks will require our CV Style driveshaft RE1883-365 and yoke RE1810.*

Features:

- Front and Rear replacement coil springs
- Front and Rear cam bolts for caster and pinion adjustment
- Bump stops
- Front adjustable track bar and rear track bar bracket
- Extended sway bar end links
- Easily upgradeable to the super-flex system

Part No.	Application
RE7121	2" Standard Coil System 2 Door
RE7122	3.5" Standard Coil System 2 Door
RE7141	2" Standard Coil System 4 Door
RE7142	3.5" Standard Coil System 4 Door





07-15 JK Wrangler 3.5" Sport Suspension Kits

Includes our new high steer kit made up of a new solid drag link that accepts OE tie rod ends while relocating the steering stabilizer above the drag link for increased ground clearance. The Sport Kit can improve the ride quality and handling on any 07+ JK or JK Unlimited.

Part No. RE7145M - JK 4Dr 3.5" with Monotube Shocks

Part No. RE7125 - JK 2DR 3.5"

Part No. RE7125T - JK 2DR 3.5" with Twin Tube Shock



NEW

Hydraulic Bump Stops

Hydraulic "air bumps" provide a huge increase in off-road performance by providing a smooth transition at full compression when compared to a harsh factory rubber bump stop. The problem is that air bumps require custom fabrication for installation... until now. Rubicon Express has designed a bolt-on kit to add their 2.0-inch hydraulic bump stops to two door JK and four door JK Unlimited Jeep Wranglers.

Part No. RE1382 Front

Part No. RE1384 Rear



Brake Lines

Our brake lines are as good as it gets and we build them to last. Features a strong woven stainless steel outer shell that protects the rubber and Kevlar housing that encases the Teflon inner hose. Built to DOT specifications.

Part No.	Application
Front	
RE1530	Wrangler JK, 24"
RE1550	Wrangler TJ/LJ/CJ 82-86, 22"
RE1552	Wrangler CJ 77-81, 20"
RE1553	Wrangler TJ/LJ, 20"
RE1555	Wrangler YJ, 28"
Rear	
RE1540	Wrangler JK, 20"
RE1513	Wrangler YJ/CJ/MJ, 22"
RE1515	Cherokee XJ/ZJ, 18"
RE1517	Wrangler TJ/LJ, 24"

JK Wrangler High Steer Kit

This kit brings your steering angles back into factory specs on 3.5"-5.5" lifted JK Wranglers. Included is a HD drag link made from solid bar for maximum strength and utilizes an OE tie rod end for simple replacement should the end become worn out. The axle mounted track bar bracket accepts and allows for adjustment with the OE track bar while also relocating steering stabilizer above the drag link.

Part No. RE2621 - 3.5" or more lift



Features:

- Chromoly Long Arms
- NEW PT-MEG Super-Ride bushings
- Designed for on and off-road performance
- Adjustable control arms with serviceable Super-Flex spherical ball joints
- Includes tuned lift springs, stainless steel brake lines, three-piece belly pan
- SYE and rear CV drive shafts available
- Specifically valved Mono-tube shocks should be used with this kit for maximum performance
- Rear Tri-Link option available

Part No.	Application
RE7224	04-06 LJ Unlimited, 4.5" with Rear Track Bar
RE7203	97-02 TJ Wrangler, 3.5" with rear track bar
RE7213	03-06 TJ Wrangler, 3.5" with rear track bar
RE7504	97-02 TJ Wrangler, 4.5" with rear Tri-Link
RE7515	03-06 TJ Wrangler, 5.5" with rear Tri-Link

Control Arms

These control arms feature the serviceable Super-Flex spherical ball joint for increased durability and articulation and are made with high strength steel that is nearly indestructible.

Part No.	Application
07-16 Wrangler JK	
RE3750	Control Arm, Front Lower, Fixed
RE3752	Control Arm, Front Upper, Adjustable
RE3755	Control Arm, Rear Lower, Fixed
RE3757	Control Arm, Rear Upper, Adjustable
Wrangler TJ/LJ, Cherokee XJ/MJ/ZJ	
RE3700	Control Arm, Front Lower, Fixed
RE3720	Control Arm, Lower, Adjustable
RE3780	Control Arm, Front Upper, Adjustable
RE3783	Control Arm, Rear Upper, Adjustable





07-15 Jeep® JK Wrangler 2/4 Door

4" Crawler Long Arm Suspension System



Part No. RS66105/B

- Front and rear coil springs
- Extended length front and rear sway bar end link
- Upgraded front and rear bump stop spacers
- Front and rear extended length brake lines
- High-articulation front and rear long arm design
- Heavy-duty tubular-style front radius arm design
- Will not affect the Electronic Stability Control System
- Compatible with both 2WD and 4WD

**No exhaust modifications required for 07-11
Brackets are high-strength, low-alloy steel*

4" Sport Suspension System Part No. RS66102B



- Front and rear coil springs
- 100-percent bolt-on system
- Front adjustable track bar included
- Brackets are high-strength, low-alloy steel
- Compatible with both 2WD and 4WD

*Available in black finish only.
Cross over exhaust pipe RS720003 required for 2014-12 JK.*

4" Trail Suspension System Part No. RS66103/B



- Front and rear coil springs
- 100-percent bolt-on system
- High-articulation front & rear lower short arm design
- Brackets are high-strength, low-alloy steel
- Compatible with both 2WD and 4WD

*Available in black or red finish
Cross over exhaust pipe RS720003 required for 2014-12 JK.*

97-06 Jeep® TJ/LJ



3.5" Short Arm Suspension System Part No. RS6504

- New forged pitman arm
- High-articulation 2" O.D. x 3/16" I.D. control arms designed for increased approach angles with a patented bushing system
- Front adjustable track bar
- Rear track bar relocation bracket
- Front and rear heavy duty springs
- No exhaust modifications required
- Industry leading front sway bar disconnect design
- Transfer case shifter relocation bracket and drop down spacers to allow use of factory drive shafts
- New brake lines for increased articulation

Available in red finish only. This suspension system was developed using a 33x12.5xR15 tire on a 15x9" wheel with 3.8" B.S.

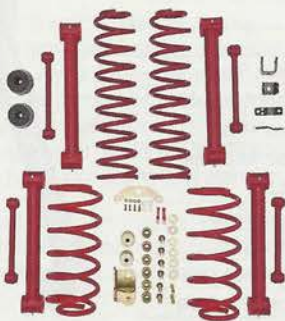

3.5" Sport Suspension System Part No. RS6501

- No exhaust modifications required
- Track bar relocation bracket rear
- New lower links
- Front and rear heavy duty springs
- Transfer case shifter relocation brackets and drop down spacers to allow use of factory driveshafts

Available in red finish only. This suspension system was developed using a 33x12.5xR15 tire on a 15x9" wheel with 3.8" B.S.



See Rancho's line of RockGEAR
body protection on page 50

3-3.5" Progressive Sport Suspension System



Part No. RS66110B

- Front and rear progressive rate coil springs
- 100-percent bolt-on system
- Front adjustable track bar included
- Brackets are high-strength, low-alloy steel
- Compatible with both 2WD and 4WD
- Limited Lifetime Warranty

*Available in black finish only.
Cross over exhaust pipe RS720003 required for 12-15 JK.*

3" Trail Suspension System Part No. RS66107/B



- Front and rear coil springs
- 100-percent bolt-on system
- Adjustable front and rear upper short arm design
- Brackets are high-strength, low-alloy steel
- Compatible with both 2WD and 4WD

*Available in black or red finish
Cross over exhaust pipe RS720003 required for 12-15 JK.*



4" Crawler Short Arm Suspension System Part No. RS66104/B



- High-articulation front and rear lower short arm design
- Adjustable front and rear upper short arm design
- Front and rear coil springs
- Brackets are high-strength, low-alloy steel
- Compatible with both 2WD and 4WD

*Available in black or red finish.
Cross over exhaust pipe RS720003 required for 12-15 JK.*



3" Sport Suspension System Part No. RS66106B



- Front and rear coil springs
- 100-percent bolt-on system
- Front adjustable track bar included
- Brackets are high-strength, low-alloy steel
- Compatible with both 2WD and 4WD

*Available in black finish only.
Cross over exhaust pipe RS720003 required for 12-15 JK.*



Cross Over Exhaust Pipe Kit Part No. RS720003



- Clearance is optimized for 2014-12 Jeep® Wranglers with 2 - 5" lift height
- Mandrel-bent 409 stainless steel tubing

*Trimming or modification may be required to provide proper tire clearance.
Shocks sold separately (RS9000XL™, RS7000MT™ or RS5000™)*

Tech^{Tip}

After installing a lift kit on your Jeep®, it is a good idea to upgrade your factory steering stabilizer to something a little more heavy duty. Even though it is not necessary, it will help dampen the harshness of the road while running larger tires.

2.5" Short Arm Suspension System Part No. RS6503 (not shown)



- No exhaust modifications required
- Rear track bar relocation bracket
- New lower links
- Front and rear coil springs
- Transfer case shifter relocation brackets and drop down spacers to allow use of factory drive-shafts

Available in red finish only. This suspension system was developed using a 33x12.5xR15 tire on a 15x9" wheel with 3.8" B.S.



JSPEC™ Suspension Systems

JSPEC™ Suspension by JKS products deliver American Ingenuity and Workmanship to consumers without compromising performance or dependability. JSPEC™ Suspension by JKS are comprised of JKS Manufacturing components, the best and most trusted Jeep® accessories in the industry.



B1 Body Lift 1.25" Lift

An economical solution to tire clearance problems, without affecting center of gravity, spring rate or steering geometry like suspension modifications. Are specifically designed to work in conjunction with the OE body mounts. Provide 1.25" of additional tire clearance, without exceeding the safe working parameters for severe off-road use. No modifications are required to the fuel tank, air conditioning, radiator, or brakes. Premium Dura-Thane™ poly material with a hardness of 94 durometer.

Quicker Disconnects™

Temporarily disconnect your front swaybar for 30% more axle articulation. Adjustable design enables you to fine-tune the length to accommodate variations in lift height or unlevelled vehicles. Convenient grease zerk fittings make lubrication easy. Satin black powder coat finish.



Part No.	Application
2030	07-15 Wrangler JK, 0-2.0" Lift
2034	07-15 Wrangler JK, 2.5-6.0" Lift
2000	97-06 Wrangler TJ, 0-2.0" Lift
2001	97-06 Wrangler TJ, 2.5-6.0" Lift
4100	76-95 CJ and Wrangler YJ, Any Lift (Welding Required)

Adjustable Track Bars

Variable length design allows you to precisely center the axle housing beneath the vehicle – a necessary adjustment whenever ride height is changed. Made from ultra-strong DOM steel tubing and shaped for correct geometry and clearance. Satin black powder coat and zinc plated.

Part No.	Application
0GS121	07-15 Wrangler JK, Front, 1.0-6.0" Lift
0GS159	07-15 Wrangler JK, Rear, 0-6.0" Lift
0GS125	97-06 Wrangler TJ, Front, 4.0" Lift or Greater
0GS126	97-06 Wrangler TJ, Front, 1.0-3.5" Lift
0GS128	97-06 Wrangler TJ, Front HD, 2.5" Lift or Greater
0GS151	97-06 Wrangler TJ, Rear, 0-6.0" Lift
0GS151B	97-06 Wrangler TJ, Rear, 3.0" Lift or Greater (Requires CV Driveshaft)



Sector Shaft Reinforcement Kit

Prevent steering box failures on your JK Wrangler by stabilizing and supporting the output shaft with this multi-function reinforcement kit. At the same time you will be strengthening the front track bar bracket and connecting the left and right chassis rails for increased load capacity and a dramatic improvement in steering responsiveness.

Part No. **0GS166** - 07-15 Wrangler JK, front (welding required)



Part No.	Application
108K	3.5" J Kontrol Suspension System, 07-15, Wrangler JK 4DR
100K	3.5" Suspension System, 07-15, Wrangler JK 4DR
102K	2.5" Suspension System, 07-15, Wrangler JK 4DR
109K	3.5" J Kontrol Suspension System, 07-15, Wrangler JK 2DR
101K	3.5" Suspension System, 07-15, Wrangler JK 2DR
103K	2.5" Suspension System, 07-15, Wrangler JK 2DR

Part No.	Application
9904	97-06 Wrangler JK*
9903	87-95 Wrangler YJ
9902	76-86 CJ5 and CJ7
9901	78-82 CJ8

*Compatible with TJ Rubicon and Unlimited models.

Adjustable Control Arms

Heaviest duty on the market today! Over 3" of adjustment allows you to control pinion angles and position the axle housing for proper tire clearance. OE bushings reduce noise and vibration for a quiet, comfortable ride. Satin black powder coat and zinc plated. Sold in pairs.



Part No.	Application
6155	07-15 Wrangler JK, Rear Lower Arms
7150	07-15 Wrangler JK, Front Upper Arms
6100	97-06 Wrangler TJ, Front or Rear Lower Arms
7100	97-06 Wrangler TJ, Front Upper Arms
7101	97-06 Wrangler TJ, Rear Upper Arms

Track Bar Brackets and Bracing

Heavy duty axle braces transform the weak factory track bar mounts on JK models into fully reinforced mounting points that will withstand any amount of punishment. If your rear factory axle bracket has already failed, the OE replacement bracket will provide a much stronger mounting point. Choose a bolt-on relocation bracket to correct rear track bar geometry on CV driveshaft applications.



Part No.	Application
0GS161	07-15 Wrangler JK, Front Axle Brace (Weld-On)
0GS169	07-15 Wrangler JK, Rear Axle Brace (Weld-On)
0GS168	07-15 Wrangler JK, Rear OE Replace. Bracket (Weld-On)
0GS170	07-15 Wrangler JK, Rear Relocation Bracket
0GS160	97-06 Wrangler TJ, Rear Relocation Bracket

Adjustable Coil Spacers

Add adjustable ride height to your lift! The ACOS™ system enables you to fine-tune your suspension to compensate for the added weight of bumpers and winches, sagging springs, tire size changes, or to level your Jeep® from side-to-side or front-to-back. ACOS Pro™ includes built-in hydraulic bump shock to absorb heavy suspension impacts off-road. Instantly increases ride height a minimum of 1.0" upon installation. Sold in pairs.



Part No.	Application
2210	07-15 Wrangler JK, Front
2570	07-15 Wrangler JK, Rear
2710	07-15 Wrangler JK, Front, Incl. Bump Shock
2200	97-06 Wrangler TJ, Front
2550	97-06 Wrangler TJ, Rear
2700	97-06 Wrangler TJ, Front Or Rear Incl. Bump Shock

ACOS™



4X4 ACCESSORIES

OLD MAN EMU
4X4 SUSPENSION BY ARB

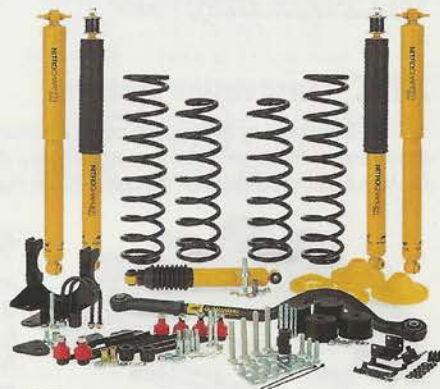

BP-51 High Performance Shock Absorbers



- Bypass technology with remote reservoir for increased oil volume and travel
- Hard anodized aircraft-grade aluminum resists heat and corrosion
- Independently adjustable in both rebound and compression
- 100% Rebuildable and re-valveable

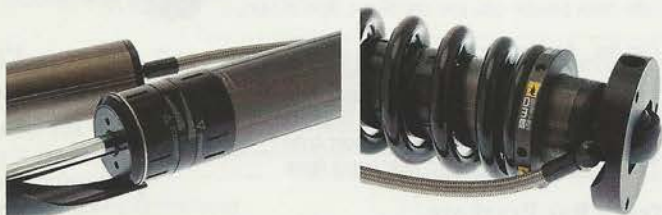

Part No.	Application
BP5160022	07-15 Jeep® JK Wrangler (With 3.5"-4.5" Lift) Front
BP5160023	07-15 Jeep® JK Wrangler (With 3.5"-4.5" Lift) Rear
VM80010014	JK Front Shock and Reservoir Mount Kit
VM80010015	JK Rear Shock and Reservoir Mount Kit



Steering Stabilizer

Jeep® JK and TJ Wrangler and Unlimited 2 and 4 door

- 9 stage coil spring valving: For optimum performance
- 14mm piston rod: Stronger than the original
- Rubber dust boot: Protects the piston rod against stone damage
- 35mm piston and bore: Increased oil volume
- Twin tube design: Protects the internal components against stone damage
- Multi lip seal: Prevents oil loss

Part No.	Application
OMESD48	Steering Stabilizer
FK50	Relocation Bracket

07-16 Jeep® Wrangler JK 2-4DR

Complete Kits Part No.	Description	Lift
OMEJK2DLKS ^{5,10,11}	Gas - Stock/Light Load (0-90LBS)	2-2.25"
OMEJK2DHKS ^{5,10,11}	Gas - Heavy Load	2-2.25"
OMEJK4 ^{5,9,10}	Gas - Light Load/Heavy Load 8	4"

⁵ Kit contains standard Old Man Emu Shocks

⁶ Due to variations in vehicle weights (aftermarket accessories), trim packers are included to adjust the ride height

⁹ When fitting larger tires, aftermarket wheels (rims) with greater offset (less backspacing) may be required to clear swaybar links and control arms.

¹⁰ Optional J.E. Reel Front replacement drive shaft and T-Case yoke. Rated for 0-6" of lift. Fits 2-Door and 4-Door models. Required for 2012+ models when fitting OMEJK4. Optional when fitting OMEJK4 to 07-11 models

¹¹ Kit does not include optional OMESD48 steering damper or damper fit kit FK50

97-06 Wrangler TJ, Unlimited

Complete Kits Part No.	Description	Lift
OMETJLKS ^{1,8,10}	Stock/Light Load (0-90LBS)	2"
OMETJHKS ^{1,8,10}	Heavy Load (90-180LBS)	2"

¹ Appropriate T-Case spacer kit is mandatory to prevent driveline vibration.

⁵ Only and are not intended for use with any Old Man Emu systems. Modified bump stops are required.

⁸ Kit contains Old Man Emu Nitrocharger Sport Shocks

¹⁰ Due to a variance in curb weight, Rubicon models may not gain the full advertised lift height

99-04¹ Grand Cherokee WJ

Complete Kits Part No.	Description	Lift
OMEWJLK ²	Stock/Light Load (0-90LBS)	1.50"
OMEWJHK ²	Heavy Load (90-200LBS)	1.50"

² Some Dana 35's 4.10 gear sets, may require a high speed carrier air locker. (RD103)



PERFORMANCE ACCESSORIES™



Performance accessories premium lift systems offer an affordable solution for your Jeep® JK. Combining performance accessories' body lift, leveling kit, and gap guards, premium lift systems are the most economical way to raise your vehicle between 3-4". Premium Lift Systems deliver the most lift for the money of any lift solution available today.

Jeep® Premium Lift Systems 11-15 Jeep® Wrangler Body Lift and Leveling All-In-One!



- Levels vehicle stance
- Body lift components include reinforced nylon body blocks
- Polyurethane intermediate spring spacers provide optimum spring preload
- Aluminum upper mounting spacers insure proper fit and function
- Includes all required mounting hardware and detailed installation instructions

Part No.	Lift	Application
PLS993	3"	12-16 Jeep® Wrangler/Unlimited 2/4Dr
PLS994	4"	12-16 Jeep® Wrangler Auto Only 2 and 4WD
PLS990	4"	07-11 Jeep® Wrangler JK, 2/4Dr, Auto Transmission
PLS992	3"	07-11 Jeep® Wrangler/Unlimited Body Lift 2 and 4WD

Tech Tip

By using a Premium Lift System, you get a Body Lift and a Leveling Kit all in one box. You can fit the tires you want while keeping the smoothness of your factory ride without changing your shocks and springs.

Jeep® Body Lifts

- Highest quality materials available
- Reinforced nylon blocks have a compression rate of more than 50,000 PSI
- All hardware is zinc plated for corrosion resistance

1" Part No.	2" Part No.	3" Part No.	Gap Guard	Rear Bumper Guard	Year	Application
993	994	—	6909	—	11-16	Jeep® JK Wrangler Auto Trans 2WD/4WD ^{14,26,29}
991	992	—	6909	—	07-11	Jeep® JK Wrangler Auto Trans 2WD/4WD ^{14,26,29}
—	982	983	6908	—	05-06	Jeep® TJ Wrangler - 6-Speed manual/auto 4WD ^{19,24,26,29}
—	972	973	6908	—	97-06	Jeep® TJ Wrangler - 5-Speed manual/auto 4WD ^{19,24,26,29}
951	—	—	6908	—	97-06	Jeep® TJ, Rubicon, Unlimited 4WD ^{19,24,26,29}
931	932	933	6907	6905	86-95	Jeep® YJ Wrangler - Manual Trans 4WD ^{2,24,26,29}
—	932A	933A	6907	6905	86-95	Jeep® YJ - Auto trans 4WD ^{24,26,29}
911	912	913	—	6905	72-86	Jeep® CJ5, CJ7, Scrambler 4WD ^{24,26,29}
—	922	923	—	—	72-85	Jeep® J10, J20, Cherokee/Wagoneer 4WD MT ²⁶

² Does not fit models equipped with automatic transmission
¹⁴ Will not fit vehicle equipped with diesel engine
¹⁹ Installation on vehicles with air conditioning will require modification to the radiator mounting flange
²⁴ Gap guards available and sold separately for this application
²⁶ No bumper brackets are included in this kit
²⁹ Or-Fab Jeep® products also available

Jeep® Gap Guards

Hides the visible gap between the body and frame once a Body-Lift has been installed

- Install easily
- Made in the U.S.A.
- Provides a finished, OE appearance to the vehicle once it's been lifted.
- Prevents excessive mud, moisture and dirt from entering into the engine compartment
- Made from high-quality molds individually designed for each vehicle application



Tech Tip

When installing your body lift kit, remember to order a set of custom-fit urethane Gap Guards to hide the gap between frame and body and keep the engine compartment clean.



Comfort Ride Lift

Daystar's Comfort Ride suspension systems are truly driven by design. Kits are custom designed to work with stock suspension components to keep cost down and quality high. High-density progressive polyurethane strut and spring spacers act as an isolator to combine moderate amounts of lift without losing the comfortable ride you have come to expect. Almost all the lifts and leveling kits used on strut applications feature easy-install design, and no disassembly of the strut is required.

- Top-mount easy-install design
- No metal-on-metal contact
- Maintains factory ride quality
- Long-lasting finish
- Limited lifetime warranty

Part No.	Application	Year	Description
KJ09161BK	Wrangler JK	07-15	Lift kit, Shocks, 1" body lift-2-3/4" lift
KJ09153BK	Wrangler JK	07-15	Lift kit & Shocks- 3" lift
KJ09156BK	Wrangler JK	07-15	Lift kit, Shocks, and 1" body lift- 4"lift
KJ09153BK	Wrangler JK	07-15	3" Lift with Scorpion Shocks; 2WD/4WD; 35" Tires
KJ09143BK	Wrangler JK	07-15	1-3/4" Lift Kit with 1" Body Lift; 2WD/4WD; 35" Tires
KJ09159BK	Wrangler JK	07-15	Suspension Lift 1-3/4 Lift
KJ09137BK	Wrangler JK	07-15	1-3/4" Lift Kit - Front and Rear Spacers; 35" Tires

Part No.	Application	Year	Description
KC09106BK	Liberty KJ	08-12	2" Lift Kit - Front and Rear Coil Spring Spacer Kit
KJ09158BK	Wrangler TJ	97-06	Lift kit & Shocks- 1-3/4" Lift
KJ09103BK	Wrangler TJ	97-06	1- 3/4" Front and Rear Lift With Extended Bump Stops
KJ09126BK	Wrangler TJ	97-06	3" Lift Kit, With Shocks
KJ09155BK	Wrangler TJ	97-06	3" Suspension Lift with 1" Body Lift
KJ09113BK	Grand Cherokee WJ	99-04	2" Lift Kit - Front and Rear Coil Spacers Only (4 Per Set)



Lifted Height

1.5" Comfort Ride Lift Kit for 15-16 Jeep® Renegade

The Comfort Ride kit is 100% bolt on, easy to install, and FMVSS 126 Compliant. Daystar's top load strut stud extender mounts and coil spring spacers allow you to install the leveling kit without having to disassemble the strut assembly. The kit fits all Renegade models including 2WD and 4WD Sport, Latitude, Limited and Trailhawk models.

- Fit up to two sizes of larger tires mounted on stock wheels
- Lifetime Go Everywhere Warranty

Part No. KJ09168BK

Budget Boost, Body Lifts and Leveling Kits

Daystar kits offer an improved ride, more ground clearance, and the ability to run larger tires and wheels, while reducing noise, vibration, and harmonics (NVH).

- Made in the USA
- Go Everywhere Warranty
- Easy install Design
- No metal on metal contact
- No welding required



Part No.	Application	Year	Description
KJ09138BK	Wrangler JK	07-15	3/4" Budget Boost - Front & Rear Spacers
KJ09100BK	Wrangler TJ	97-06	1-3/4" Budget Boost - Front or Rear Coil Spacer Kit (2 Per Set)
KJ09139BK	Wrangler JK	07-15	3/4" Budget Boost; Front Only
KJ09140BK	Wrangler JK	07-15	3/4" Budget Boost; Rear Only
KJ09152BK	Wrangler JK	07-15	2" Leveling Kit - Front Coil Spacers (Pair) FMVSS126 Compliant
KJ04520BK	Wrangler JK	07-15	1" Body Lift and Hardware. Auto Only. FMVSS126 Compliant
KJ09108BK	Wrangler TJ	97-06	3/4" Budget Boost - Front and Rear Spacers (4 Per Set)
KJ09107BK	Cherokee XJ	84-01	3/4" Budget Boost - Front Spacers (2 Per Set)

TUFF COUNTRY

EZ-RIDE SUSPENSION

4" Lift System

07-15 Jeep® Wrangler

Tuff Country's Jeep® Wrangler JK 4" lift kits are available in 3 different configuration depending on the vehicle owner's needs. The most extreme being the "EZ-Flex Performance" JK lift kit. Designed for the serious off-roader. This high performance off road suspension system includes upper and lower EZ-Flex control arms in the front and rear of vehicle along with an adjustable front track bar.



- EZ-Ride Coil Springs for a great ride
- Simple bolt-on installation
- Front and Rear EZ-Flex lower control arms (Performance kit includes upper and lower)
- Limited lifetime warranty



3" Lift Kit

07-15 Jeep® Wrangler

This affordable and easy to install suspension lift kit is a great option for those that do occasional off-roading and want some additional height to clear larger tires. Included are front and rear EZ-Rid coil springs, a rear track bar bracket and front sway bar end links.

- Rear track bar
- EZ-Ride Coil Springs for a great ride
- Simple bolt-on installation
- Limited lifetime warranty



3.5" Lift Kits

87-01 Cherokee XJ (with rear blocks)

Tuff Country EZ-Ride Suspension's 3.5" lift kits for the Jeep® Cherokee XJ allow for use of up to 31" tires and gives additional fender clearance. This kit is offered with standard extended lower control arms or with EZ-Flex control arms which allow for better articulation when off-roading. Both lift kits also include EZ-Ride front coil springs, a track bar relocating bracket, transfer case drop kit and rear lift blocks and extended bolts.



2" Lift Kits

07-15 Jeep® Wrangler

Tuff Country EZ-Ride Suspension's 2" Jeep® Wrangler JK lift kits allow for slightly larger tires and give additional fender clearance. These easy to install kits are constructed of durable polyurethane and mount above the factory coil springs.

- Constructed of durable polyurethane
- Maintains a factory or near factory ride
- Simple bolt-on installation
- Limited lifetime warranty



4" Lift Kits

97-02 Jeep® TJ (EZ-Ride)

Tuff Country EZ-Ride Suspension's 4" EZ-Ride lift kits for the Jeep® Wrangler TJ allow for use of up to 33" tires and gives additional fender clearance. This lift kit includes EZ-Ride front and rear coil springs for a great ride. Also included are front and rear lower control arms (with poly bushings), front and rear track bar relocation brackets, transfer case drop kit and all required hardware.



Box Kit Part No.	Front Shocks Part No.	Rear Shocks Part No.	Application	Lift
42005 (6)	62232	62261	07-15 Wrangler JK 4 Door Only (poly)	2"
43000	62262	62261	07-15 Wrangler JK 2 Door	3"
43001	62262	62261	07-15 Wrangler JK 4 Door	3"
44000 (5, 6)	62262	62301	07-15 Wrangler JK 4 Door Only (EZ-flex)	4"
44002 (6)	62262	62301	07-15 Wrangler JK (EZ-Flex Performance Kit)	4"
43800	62232	62261	87-01 Cherokee XJ	3"
43801	62232	62261	87-01 Cherokee XJ	3.5"
42006	N/A	N/A	11-12 Grand Cherokee	1.75"/0"
42901	62232	62231	97-06 Jeep® TJ	2"
44900	62232	62261	97-02 Jeep® TJ (EZ-Ride)	4"
44902 (8)	62232	62231	97-06 Jeep® TJ (EZ-Flex)	4"
42025	N/A	N/A	01-06 Jeep Liberty	2"

(6) Recommended to replace the front and rear stock drive shafts with extended drive shafts. Front Part No. 40800, Rear Part No. 40801.

(8) Will fit Rubicon models

(5) Requires new rims with 4.5" backspacing or less

Due to variations in stock rear block height 1.5" add-a-leafs are recommended for vehicles with 2" rear stock blocks, 2.5" and 3" leveling kit are recommended for vehicles with 3.5" rear stock blocks



Pitman Arm

Part No. 70401 - Jeep® YJ and TJ Wrangler 1987-2006





Off-Road Lift Stabilizer Bars

- Unique style of mounting allows for maximum droop and compression
- Provides optimum ride quality and control without sacrificing suspension travel
- Adjustable front and rear sway bars offers fine-tuning to the driver's needs
- Improved ground clearance
- Adjustable quick disconnect end links included in front kits



Front Kit Part No.	Front Diameter	Rear Kit Part No.	Rear Diameter	Lift Front/Rear	Application
7870	1-1/4"	7871	3/4"	4-6"	97-06 Jeep® TJ Off-Road
7866	1-1/4"	7871	3/4"	4-6"	97-06 Jeep® TJ Street
7876	1-1/4"	7706	7/8"	3-5"	07-15 Jeep® JK Off-Road
7865	1-1/4"	7706	7/8"	3-5"	07-15 Jeep® JK Street
		7859		3-5"	07-15 Jeep® JK Quick Disconnect End Links Only

SumoSprings

07-15 Jeep® Wrangler

- Compress up to 80% of their original height with full memory rebound
- Provide progressive load control, easier initial compress allowing softer engagement, greater resistance with heavier load, restrict body roll and enhance overall driver control
- More than just a bump stop, this variable rate spring eliminates the unforgiving, banging effect produced by similar frame-mounted products
- Manufactured from proprietary closed microcellular urethane
- Airless, never leak and cause a loss of performance and rupture proof
- 100% maintenance free

Part No.	Application
SSF40147	Front Medium Duty Loading
SSF40154	Front Heavy Duty Loading
SSF40254*	Front; Unlifted
SSF40354*	Front; With 2" Lift
SSF40454*	Front; With 4" Lift

**For Off-Road and Race Use Only*



Suspension Enhancement System

07-15 JK and 97-06 TJ

- Eliminate suspension sag and cushion road shock
- Reduce sway and improve roll stability
- Professional installation required
- Improves roll control
- Trouble and maintenance free
- Satisfaction guarantee and lifetime warranty



Part No. JFTJ - Front Axle for JK and TJ
Part No. JRJK - Rear Axle for JK only



5" Suspension System

07-15 Jeep® Wrangler JK

- Kit includes: coil springs, shocks, lower front links, lower rear links, rear bump stop brackets, rear bump stop spacers, front track bar bracket, front double disconnect end links
- Includes rear extended sway bar end links, rear track bar brace, and hardware kit



Part No. BM1841561



Leveling Kit

07-15 Jeep® JK Wrangler ALL

- Maintain your factory ride
- Increases tire clearance while offering a refreshing commanding view of the road or trail
- No cutting or welding required



Part No. J15LL1 - 1.5" Front Lift





Unique "Through the Shaft" Design

2.0 Performance Series Stabilizer ATS Steering Stabilizer

Off-Road Tough!

The FOX Performance Series Adjustable Through Shaft (ATS) steering stabilizer offers unrivaled steering control and a striking high tech appearance. The technologically advanced design cancels unwanted steering forces in both directions, taking the place of two conventional opposing stabilizers. It will also respond to your input with 24 clicks of external adjustment to fine tune the feel. The integrated reservoir allows for additional fluid capacity and improves cooling during extreme use. Also included is FOX's relocating hardware that moves the steering stabilizer up and out of the way utilizing a new track bar relocation bolt and 1-3/8" tie-rod mounting clamp. An optional 1-5/8" mounting clamp is available for larger aftermarket tie-rods. The ATS represents a revolutionary breakthrough in stabilizer design.

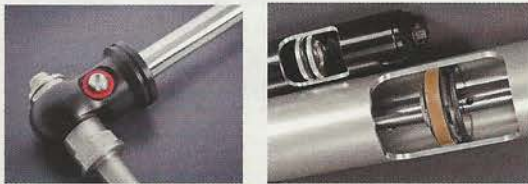

Part No.	Application
98302070	10-15 Jeep® Wrangler JK 2WD/4WD, for Factory Size Tie Rod
98302088	07-15 Jeep® Wrangler JK 2WD/4WD, for Aftermarket 1-5/8" Diameter Size Tie Rod

2.0 Evolution Series IFP Smooth Body Shock and Stabilizers

The 2.0 Evolution Series IFP smooth body shocks give you increased ride quality and the control you need when heading into the unknown. They use our proven damping technology to provide a comfortable on-road ride and predictable off-road handling in a variety of conditions. The large 5/8" alloy steel shock shaft adds increased strength and rigidity. The shafts are NitroSteel® hard-coated to resist pitting and scratches that can damage shaft seals. Our Internal Floating Piston (IFP) separates the shock oil from the high-pressure, nitrogen charged gas chamber. The IFP eliminates oil aeration allowing maximum performance from the factory-tuned precision valving.

Our bolt on, 2.0 Evolution Series IFP shocks provide increased damping in any terrain. Experience for yourself the added performance and precision control Evolution Series smooth body shocks deliver.



Part No.	Application	Lift
98350001	07-15 Jeep® Wrangler JK 2WD/4WD	Front 1.5-3.5"
98350002	07-15 Jeep® Wrangler JK 2WD/4WD	Front 4-6"
98350003	07-15 2WD/4WD Rear	1.5-3.5"
98350004	07-15 2WD/4WD Rear	4"-6"
98350000	Stabilizer for all JK's 07-15	

PERFORMANCE SERIES

Race Performance Guaranteed Factory Fit For Stock or Lifted Jeep® Vehicles

2.0 Smooth Body IFP

Aluminum body is incredibly strong and lightweight. Metal impact extruded aluminum provides superior cooling and will never rust. Race-style design allows factory servicing. Components that wear can be replaced by factory technicians, restoring the shock to peak performance. Large 5/8" diameter shaft is chromed and induction case hardened to more than 55 Rockwell to defy pitting and Internal Floating Piston (IFP) isolates the shock fluid from the high-pressure nitrogen charge assuring maximum damping and sustained fade-free performance.

2.0 Smooth Body Reservoir

EXTERNAL RESERVOIR allows additional oil and nitrogen capacity and further enhances cooling. INCLUDED BILLET ALUMINUM CLAMP looks clean and positively secures the reservoir.



Front Smooth Body IFP Part No.	Front Smooth Body Reservoir Part No.	Rear Smooth Body IFP Part No.	Rear Smooth Body Reservoir Part No.	Application	Front and Rear Lift
98524027	—	98524028	—	Jeep® Wrangler JK 07-15 4WD	0-1
98024887	98524015	98024888	98524016	Jeep® Wrangler JK 07-15 4WD	1.5-3.5
98024641	98524011	98024642	98524012	Jeep® Wrangler JK 07-15 4WD	4-6
—	98524013	—	98524014	Jeep® Wrangler JK 07-15 4WD	6.5-8
98024643	98524108	—	—	Jeep® Wrangler TJ /LJ 06-97 4WD	3-4.5
98024042	98524109	98024645	—	Jeep® Wrangler TJ /LJ 06-97 4WD	5-6
98024644	—	98524065	98524114	Jeep® Wrangler TJ /LJ 06-97 4WD	6.5-8
98024643	98524108	98024645 NOTE G	98524112	Jeep® Cherokee XJ 01-84 4WD	2-3.5, 2-4 or 2.3
98024042	98524109	98524065 NOTE G	—	Jeep® Cherokee XJ 01-84 4WD	4-6, 4.5-6.5

G = Modification Required



Hydro Shocks

These shocks are recommended for multiple shock applications and mild to moderate off-road use.

- Hydraulic action
- Multi-stage velocity sensitive valving
- Twin tube construction
- Bonded iron piston
- Chromed piston rod with micro pores
- Includes red boot



7000 Series



Nitro Shocks

- 150 PSI pressurized nitrogen gas
- Multi-stage velocity sensitive valving
- Twin tube construction
- Bonded iron piston
- Chromed piston rod with micro pores
- Red polyurethane bushings
- Includes red boot

N8000 Series



Monotube Shocks



- High-pressure nitrogen gas charged
- Custom tuned for each vehicle
- 180° directional mounting
- Large 46mm bore
- No fade or lag for consistent performance
- Monotube design
- Fastest responding shock ever
- Dirt seal protection for oil seal and rod bearing

M9500 Series



PERFORMANCE SUSPENSION & SHOCKS

RS5000™X Shock Absorbers

- Progressive engagement valving
- Tuned compression control valve
- Enlarged 2-1/4" twin tube body
- Gas pressurization of shock
- 16mm Nitro-carburized rod
- Full-displaced 35mm bore
- 1-3/8" diameter sintered iron piston
- Protective boot included



RS7000MT™ Shock Absorbers

- Monotube design with high pressure nitrogen gas charge
- 1.97" (50mm) body diameter
- Brushed and Zinc plated with a clear coated finish
- Ten-stage velocity sensitive valving
- 14mm Chrome rod
- Protective boot included
- 90-day free ride offer

RS7000 Series



RS9000XL Shocks

- 2.75" body diameter
- 9-position tuning
- Nitrogen gas filled
- Liquid metallic finish
- Protective boot included
- 90-day free ride offer



MX-6 Adjustable Monotube Shocks

- 6-way external ride control adjustability
- Nitrogen gas charged
- Velocity-sensitive valving
- Gun-drilled 14" hardened chrome shaft

MX6000 Series



Pro Runner Performance Monotube Shocks

- Height adjustable 0"-2.75"
- Brushed and zinc plated
- Nitro charged monotube design
- VSRT™ - vehicle specific ride tuning
- 6061-T6 billet collar

ZX2000 Series



BILSTEIN®



See In-Store for 5160, 6112, 8125 and 9100 Series Custom Sizes



8125 Series
Designed For The Serious Off-Road Enthusiast

- Available in 46mm and 60mm monotubes
- Threaded body with dual rate coilover hardware
- Monotube design for fade-free performance
- Remote reservoir for greater resistance to heat
- High temperature seal extends life of shock
- 22mm case hardened piston rod provides brute tensile strength while resisting sand blasting and rock chipping
- Zinc plated for resistance to off-road elements
- High temperature, size - 8 hose
- Owner rebuildable
- Industry standard 5/8" bearing
- All components are billet machined. No cast parts used
- Made in the USA



5160 Series
Stock Location Remote Reservoir Shocks

- Unique digressive valving system instantly produces full damping capability
- Remote reservoir dramatically increases shock oil capacity for even greater heat dissipation and damping sensitivity
- Reservoir mounting configuration designed specifically for each vehicle application – no welding required
- For increased wheel travel and more shaft movement, the “floating” dividing piston is located in the reservoir



6112 Series
Ultimate Suspension Solution

- Large diameter bore for increased oil capacity and durability
- BILSTEIN's industry leading monotube gas pressure design
- Lighter spring rate paired with heavier 60mm damping provides an extremely compliant ride
- Features high performance springs
- Bolt-in kit features adjustable ride height and includes spring mounting hardware



9100 Series Coilover
Available in 46mm and 60mm Models

Developed for the professional off-road racer, the BILSTEIN 9100 Series is truly state-of-the-art. The Coilover offers the same damping features as the standard body shock with the ability to mount an external coil spring for load carrying capability.

- Monotube gas pressure construction
- Designed to combine the function of damper and spring
- 2.65 or 2" (OD) Body
- Coil Spring Hardware: 3" or 3-5/8" (ID)
- Hose length and Fittings Options: Straight, 90 degree, 45 degree
- Valving can be adjusted internally for rebound and compression
- Completely owner rebuildable

F4B0AXXX Series



Front Part No.	Rear Part No.	Shock Series	Application	Lift Front	Lift Rear	Notes
24146708	24146715	5100 Series	Wrangler JK 07-15	1.5-3"	2"	2,13
25187656	25187663	5160 Series	Wrangler JK 07-15	1.5-3"	2"	2,13
24186995	33186887	5100 Series	Wrangler JK 07-15, Short Arm	3.5-5"	4"	2
25187632	25187649	5160 Series	Wrangler JK 07-15, Short Arm	3.5-5"	4"	2
24186872	33186887	5100 Series	Wrangler JK 07-15, Long Arm	3.5-5"	4"	2
25187632	25187649	5160 Series	Wrangler JK 07-15, Long Arm	3.5-5"	4"	2
24158428	—	5100 Series	Steering Stabilizer, Wrangler JK 07-15	—	—	—
24186810	24186827	5100 Series	Wrangler TJ 96-06	0-2"	0-2"	—
25193138	25193145	5160 Series	Wrangler TJ 96-06	0-2.5"	0-2.5"	17
24185257	24185264	5100 Series	Wrangler TJ 96-06, Short Arm	3"	3"	2
25193114	25193145	5160 Series	Wrangler TJ 96-06, Short Arm	3"	3"	2
24188180	33185514	5100 Series	Wrangler TJ 96-06, Short Arm	3.5-4"	3.5-4"	2
24185929	33185934	5100 Series	Wrangler TJ 96-06, Long Arm	3.5-4"	3.5-4"	2
24185929	33185934	5100 Series	Wrangler TJ 96-06, Long Arm	4"	4"	2
24187190	33185934	5100 Series	Wrangler TJ 96-06, Long Arm	4.5"	4.5"	2
24185943	33185934	5100 Series	Wrangler TJ 96-06, Long Arm	5-6"	5-6"	2
24185622	24185639	5100 Series	Cherokee XJ 84-01	2-3"	2-3"	2

5100 Series Shocks
Monotube Gas Pressure Shocks for Lifted Vehicles

- Monotube design for cooler, more efficient operation and longer life
- 46mm piston diameter provides superior handling and performance
- Patented digressive valving instantly reacts to changing surface conditions for maximum comfort and control on or off-road
- Split compression and rebound valving tuned for each specific application
- Jeep® applications available for stock height to 6" lifted



2) Compression bump stop on chassis may need to be modified to prevent damage to the shock absorber
 13) Must use wheel spacers or offset aftermarket wheels.
 17) Zinc plated blue boot 5100 series



NEW



High quality monotube construction in a full black out package. Stealth has the edge when it comes to superior ride quality for your vehicle at an affordable price. Welcome to the dark side.

- Black shock body
- Black nitrocarb piston rod
- Excellent ride quality

FTS6000 Series

Dirt Logic 2.5 Shocks

- 2.50" OD steel body
- 2.25" OD billet aluminum piston
- 7/8" induction hardened chrome piston rod
- Adjustable coilover construction
- 5/8" spherical ball or urethane mounting ends
- Optional 2.25" OD reservoir with 8 stainless steel o-ring hose
- Black anodized finish

FTS810000 Series



Sensa-Trac Shock Absorbers

- Fluon banded piston, part of the Safe Tech™ system, works with the patented groove tube technology to provide superior responsiveness to changing road conditions
- Application engineered with fully displaced valving for optimum light truck ride tuning
- Nitrogen gas charge helps to maintain tire to road contact by reducing aeration, improving ride and handling

37000 Series



Gas-Magnum Shock Absorbers

- Designed specifically for hard-working mid to full-size pick-ups and vans
- The largest shock in the industry provides greater oil capacity, allowing superior heat dissipation
- Provide firm control without a harsh ride

34000 Series

ENERGY SUSPENSION
Performance POLYURETHANE Components

HYPER-FLEX

Proven on and off-road, under the most demanding conditions! Whether old or new, all vehicles will achieve that level of performance that has made ENERGY SUSPENSION the most asked-for name in performance polyurethane suspension components. DURABLE HYPER-FLEX™ components do not rot or deteriorate from exposure to oils and undercar chemicals or atmospheric conditions like smog and ozone. Unlike O.E.M. rubber, HYPER-FLEX components will not break down and deteriorate, causing mushy handling and poor steering response.

Jeep® TJ Wrangler 97-06

Part No.	Description
23107G	Rear end control arm bushing set
25110G	Complete sway bar bushing set
26101G	Front coil spring isolator (OE height)
26102G	Coil lift isolator set (front or rear 1.75")
26103G	Coil lift isolator set (front or rear .75" lift)
25111G	Rear sway bar bushing set
27102G	Front track bar bushing set
27103G	Rear track bar track bar bushing set
21103G	Transmission mount

Note: Parts shown are Black. For Red, replace "G" with "R" in part number.



Hyper-Flex® Systems

Front and rear control arm bushings (2), front and rear greaseable sway bar and end link bushings, front and rear track bar set, front and rear coil spring isolators, front and rear bump stops, body mounts.

Part No. 218107G - 97-06 Jeep® TJ
Part No. 218108G - 07-16 Wrangler JK 4 door

Front and rear spring and shackle bushings, front sway bar and end link bushings, front and rear track rod bushings, body mounts, transmission mount, tie-rod end boots.

Part No. 218101G - 87-95 Jeep® YJ Wrangler

93-98 Jeep® Grand Cherokee XZ

Part No.	Description
23103G	Front end control arm bushings
25108G	Front sway bar bushing set
25109G	Rear sway bar bushing set
27102G	Front track arm bushing set
27103G	Rear track arm bushing set
26103G	Coil lift isolator set .75"
26102G	Coil lift isolator set 1.75"
21104G	Motor mounts (2 per set)

Jeep® YJ Wrangler 87-95

Part No.	Description
22107G	Front and rear leaf spring bushing set
24105G	Body mount set
913101G	Tie rod boots
24101G	Front or rear track arm bushing set
21104G	Motor mount (2 per set) 6 cyl.
31107G	Transmission mount
22110G	Front or rear frame shackle bushing



Pitman Arm

With the drop pitman arm, the drag link attachment point is moved down to reduce the angle. Aftermarket pitman arms are designed specifically for off-road terrain, with more durability than a stock arm.



- Part No. JA770 - 07-15 Jeep® JK Wrangler 4-7"
- Part No. JA500 - 97-06 Jeep® TJ Wrangler with power steering 8"
- Part No. JA750 - 97-06 Jeep® TJ Wrangler with power steering 4-6"
- Part No. JA850 - 87-96 Jeep® YJ Wrangler with manual steering 4-6"
- Part No. JA750 - 87-96 Jeep® YJ Wrangler with power steering 4-6"



- Part No. YJ400 - 87-06 Jeep® YJ and TJ Wrangler 4"



Shock Relocation Brackets

- Part No. TJRSB10 - 97-06 Jeep® TJ

Sway Bar Replacements

A sway bar provides two main functions. The first main function is the reduction of body roll. The second function is to tune the handling balance of a vehicle.



- Part No. RSBA410 - 97-06 Jeep® TJ Wrangler Front
- Part No. JFSBA10 - 97-06 Jeep® TJ Wrangler Rear



Stabilizer Bar

RockLock selectable sway bar for the Jeep TJ is totally adjustable for on and off-road use.



- Part No. JFSBA10 - 97-06 Jeep® JK Wrangler



Adjustable Track Bar

It provides the hold of the axle, controls the lateral force, and keeps what is kept centered.

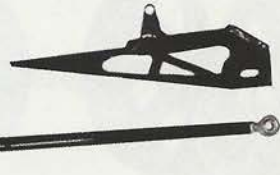

- Part No. FTBA45 - 07-15 Jeep® JK Wrangler Front 4-6"
- Part No. RTBA45 - 07-15 Jeep® JK Wrangler Rear 4-6"
- Part No. TBA10 - 97-06 Jeep® TJ Wrangler Front 4"
- Part No. TBA60 - 97-06 Jeep® TJ Wrangler Front 6"
- Part No. TJRTB - 97-06 Jeep® TJ Wrangler Rear 2-4"
- Part No. YJ5LK - 87-95 Jeep® YJ Wrangler 6"



- Part No. JTB402 - 07-15 Jeep® JK Wrangler Front 2-6"
- Part No. JTB400 - 97-06 Jeep® TJ Wrangler Front 2-5" Dana 30
- Part No. JTB403 - 97-06 Jeep® TJ Wrangler Front 2-5" Dana 44
- Part No. JTB401 - 97-06 Jeep® TJ Wrangler Rear 2-5"



Transfer Case Lowering Kits

Kits are simple to install and eliminate vibration and drivetrain angle problems.

- Part No. TCL103 - 03-06 Wrangler TJ + Rubicon 4WD; 2-2.5" Lift
- Part No. TCL153 - 03-06 Wrangler TJ + Rubicon 4WD; 3.5-4" Lift
- Part No. TCL101 - 97-02 Wrangler TJ 4WD; 2-2.5"
- Part No. TCL151 - 97-02 Wrangler TJ 4WD; 3.5-4"
- Part No. TCL25 - 87-96 Wrangler YJ 4WD; 2-4" Lift



Transfer Case Slip Yoke Eliminator Kit

- Allows for 4-1/4" to 6-1/2" drive shaft length increase



- Part No. RR231 - 97-06 Jeep® JK Wrangler



- Part No. 1867660 - 97-06 Jeep® JK Wrangler



- Part No. RE1807 - 97-06 Jeep® JK Wrangler



- Part No. 4007 - 97-06 Jeep® JK Wrangler



- Part No. 4444401 - 97-06 Jeep® JK Wrangler

Steering Stabilizers

A steering stabilizer is a dampening shock for the steering system. Basically, what it does is dampens the harshness of the highway, of the "shimmy" from running the additional weight of larger tires and wheels, and therefore places control back into the driver's hands. These can come in a single or dual set up.



- Part No. 7003 - 07-15 Jeep® JK Wrangler OEM
- Part No. 7203 - 07-15 Jeep® JK Dual
- Part No. 7119 - 97-06 Jeep® TJ Wrangler Single
- Part No. 7219 - 97-06 Jeep® TJ Wrangler Dual
- Part No. 7009 - 87-96 Jeep® TJ/YJ Wrangler OEM



- Part No. RS5407 - 87-06 Jeep® TJ and YJ Wrangler Single



- Part No. 220500 - 07-15 Jeep® JK Wrangler Single
- Part No. 219505 - 97-06 Jeep® TJ Wrangler Single
- Part No. 222586 - Jeep® JK Wrangler



- Part No. FTS8024 - JK/TJ/YJ/XJ, Single Performance Stabilizer
- Part No. FTS240911 - JK, Single Dirt Logic Stabilizer
- Part No. FTS7004 - Single Performance Twin Tube
- Part No. FTS850002 - Dirt Logic SS, Dual



Sway Bar Disconnects

- Part No. 55506 - 97-06 Jeep® TJ Wrangler 3-5"



Driveshafts



- Part No. TJRS - 03-06 Jeep® TJ Wrangler - Auto with 6 cyl Dana 35 rear
- Part No. TJRS - 97-03- Jeep® TJ Wrangler - 5 spd with 6 cyl Dana 35 rear



- Part No. 4042 - 97-06 Jeep® TJ Wrangler



33
33 Series
Chrome, Flat Black
17/18/20"



Inertia
39 Series
Satin Black/Milled
17/20"



Predator
35 Series
Gun Metal Grey, Satin Black
17/18"



Vapor
83 Series
Matte Black/Milled
17/20"



Vapor Pro
84 Series
Satin Black Milled
17/20"



Blockade
42 Series
Satin Black
17/18/20"



Phaser
41 Series
Satin Black/Machined
17/18/20"



7089
7089 Series
Gloss Black
16/17/18"



Reflex
86 Series
Satin Black, Gloss Black Milled,
Machined Face
17/20"



7036
7036 Series
Black
17/18/20"



6031
6031 Series
HD Chrome
17/18/20"



7031
7031 Series
Flat Black
15/16/17/18/20"



1069
1069 Series
Polished
15/16/17/18"



5029
5029 Series
Satin Black
16/17"



5001
5001 Series
Satin Black
16/17/18"



7069
7069 Series
Flat Black
15/16/17"



Rock Crawler
51 Series
Gloss Black
15/16"



8101
8101 Series
Gloss Black/Machined
16/17/18/20"



Vertigo
40 Series
Satin Black, Matte Graphite
17/18/20"



7032
7032 Series
Flat Black
16/17/18/20"



Syndrome
44 Series
Gloss Black Milled
20"



97
97 Series
Gloss Black
15/16/17"



7105
7105 Series
Flat Black/Machined
17/18"



7033
7033 Series
Flat Black
17/18/20"



152
152 Series
Gloss Black
15/16"



LRG101
101 Series
Black/Milled, Matte Black
17/18/20



LRG103
103 Series
Black/Milled, Chrome
17/18/20



LRG106
106 Series
Matte Black, Chrome
17/18/20



LRG107
107 Series
Machined Black, Black Milled
20"



LRG109
109 Series
Matte Black, Black Milled
20



LRG111
111 Series
Matte Black, Machined Black
20"



LRG110
110 Series
Satin Black Milled, Machined Satin Black
20"



LRG112
112 Series
Satin Black Milled
20"



Black Rock
Steel Wheel
Powder Coat, Black
16" x 8" only



Matte Black 5 Spoke
Powder Coat
Matte Black With Rivets
17" x 9" only



Two-Tone 5 Spoke Wheel
Powder Coat
Gloss Black w/ Aluminum Lip,
Black Rivets
17" x 9" only



Gloss White 5 Spoke Wheel
Powder Coat
Gloss White With Rivets
17" x 9" only



Gloss Black 5 Spoke
Powder Coat
Gloss Black With Rivets
17" x 9" only



Two-Tone Dual 5 Spoke
Powder Coat
Gloss White with Aluminum Lip, White Rivets
17" x 9" only



Drakon
15302/15304 Series
Powder Coat, Black Satin, Gun Metal
17/18/20"



Jesse Spade
15303 Series
Powder Coat, Black Satin, Gun Metal
17"



XHD
15301/15305/15311 Series
Powder Coat
Black Satin, Black w/Machined Lip,
Chrome, Gun Metal, Silver
17/18"



AR890
890 Series
Satin Black/Machined
16/17/18/20"



Soldier
188 Series
Gloss Black/Milled
17/18/20"



Trooper
189 Series
Satin Black/Milled
17/18/20"



AX195
195 Series
Black Teflon
16/17/18"



AX757
757 Series
Machined, Teflon Coated
17"



M0970
M0970 Series
Gloss Black Milled
17/18/20"



Battalion
XD813 Series
Gloss Black Milled
17/18/20"



XD809
XD809 Series
Matte Black Machined, Chrome
18/20"



XD775 Rockstar
775 Series
Matte Black, Chrome
17/18/20"



Rockstar 2
XD811 Series
Matte Black with Gloss Black
Accents
18/20"



FX12
FX12 Series
Satin Black
18/20"



FX14
FX14 Series
Satin Black
18/20"



FX14
FX14 Series
Satin Black Milled
18/20"



FX308
FX308 Series
Matte Black, Polished
Aluminum Alloy Construction
15/16/17"



Maverick
234/235 Series
Gloss Black/Diamond Cut,
Chrome Clear Coat
16/17/18/20"



X107
X107 Series
Satin Graphite w/ Satin Black Lip
Satin Black w/ Satin Black Lip
17/18/20"



Predator II 6-Spoke
249 Series
Gloss Black/Milled, PVD
18/20"



Colossus
250 Series
Gloss Black Machined Face
17/18/20"



Legend
201 Series
Satin Black with Diamond
Cut Face
15/16/17"



Legacy
504 Series
Satin Black/Diamond Cut Face,
Satin Black
16/17/18/20"



DC-2
Black/Machined
15/16/17/18/20"



Torque
Black/Machined
16/17/18/20"



DC Terrain
DC Series
Matte Black
17/20"



DC Blackout
DC Series
Matte Black
15/16/17/18/20"



DC Matrix
DC Series
Matte Black
17/18/20"



Ledge
807 Series
Satin Black/Milled
20"



Havoc
802 Series (US Patent D670223)
Satin Black/Spot Mill Dimples,
Gloss Black with Milling
17/18/20"



Rebel
809 Series
Gloss Black Milled w/ Spot Mill
Dimples, Chrome
17/18/20"



Beast II
808 Series
Gloss Black/Machined, Satin Black
18/20"



Sentry
810 Series
Gloss Black Milled, Satin Black
18/20"



Phantom
225 Series
Chrome, Satin Black,
Satin Black with Diamond Cut Accents
16/17/18/20"



Xtreme X-Lok
X102 Series
Satin Black, Satin Black with Diamond Cut Lip
15/16/17/18/20"



Sawblade
106 Series
Satin Black/Satin Black Lip
Satin Anthracite Gray/Satin Black Lip
17"



Spline
245 Series
Satin Black with Diamond Cut Accents, PVD
17/18/20"



Heist
XD818 Series
Satin Black Black With Milled Spokes
and Flange
18/20/22"



Grenade
XD820 Series
Satin Black, Satin Black Machined
Face, Satin Black Milled Spokes
22"



Classic Baja Lock
Matte Black
with Machined Simulated Beadlock Ring
15/16/17"



MM164
MM164 Series
Black Milled, Black Machined
18/20"



MM245
MM245 Series
Matte Black
17/18/20"



Classic III
Satin Black, Polished
15/16/17"



Sidebiter
Black
15/16/17"



Deegan Pro 2
Matte Black
15/16/17/18/20"



Deegan Pro 4
Matte Black
15/16/17"



MM366
MM366 Series
Matte Black
17/18/20"



MM489
MM489 Series
Matte Black
18/20"



Baja MTZ^{P3}

The new Mickey Thompson Baja MTZ^{P3} is an incredible mud terrain tire that's been specially designed with a unique silica-reinforced tread compound for longer wear, enhanced wet weather capability, and superior cut and chip resistance. The Baja MTZ^{P3} tread also features siped tread lugs with variable draft angles for better traction and stone ejection, and angled shoulder scallops with mud pocket scoops for better traction in mud and loose soil.



Baja Claw^{*}

The Baja Claw is designed for extreme driving conditions including rock crawling, mud, snow, sand, dirt, and gravel. Extra large SideBiter[®] and a cut resistant sidewall make this the toughest tire for any modified truck.



Baja ATZ^{P3}

The Baja ATZ^{P3} has a unique "hybrid" design between an all-terrain and mud terrain to give you the grip you need for your weekend adventures and the smooth ride to get you down the road in comfort. Features an extra wide footprint and beefy tread blocks for great all around traction.



Baja Claw[®] TTC RADIAL

The Baja Claw TTC Radial is the ultimate extreme traction tire. Get rugged off-road performance with the Claw's 23-degree tread pattern, large directional SideBiter[®], and tough puncture resistant sidewalls. Go where you want with the confidence that the Baja Claw TTC will pull you through!

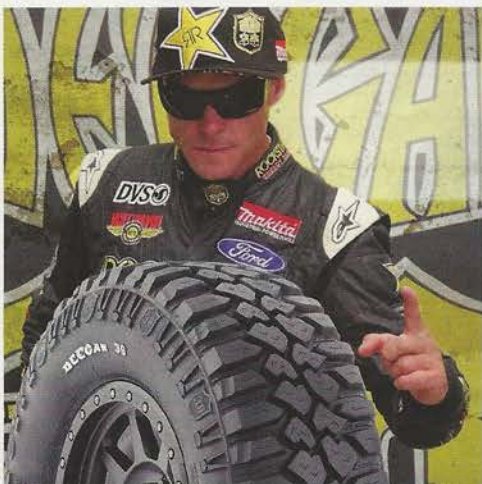

DEEGAN 38[™] TIRES

The new Deegan 38 tire from Mickey Thompson, designed in cooperation with racing icon Brian Deegan, is the ultimate all purpose mud terrain tire with aggressive style and performance and great street manners, too.

NEW

EXTREME COUNTRY™

Dick CEPEK™
TIRES & WHEELS



The NEW EXTREME COUNTRY™ mud terrain tire is designed with off-road enthusiasts in mind. The proven tread compound is excellent for maximum traction and even wear during extreme adventures.

Offered in 21 popular sizes.

PART NO.	TIRE SIZE	EQUIVALENT SIZE	LOAD RANGE	O.D. INCHES	SEC. WIDTH INCHES	TREAD WIDTH INCHES	TREAD DEPTH 32NDS	MAX INFL. PSI	MAX LOAD* LB	(MEAS. RIM WIDTH) / APPROVED RIM WIDTH - INCHES
024310	31X10.50R15LT	—	C	30.6	10.9	8.2	19.0	50	2,270	(8.5) 7.0 - 9.0
024324	33X10.50R15LT	—	C	32.8	12.1	9.8	20.0	35	2,205	(8.5) 7.0 - 9.0
024312	33X12.50R15LT	—	C	32.8	12.1	9.8	20.0	35	2,205	(10.0) 8.5 - 11.0
024311	35X12.50R15LT	—	C	34.7	12.2	9.9	20.0	35	2,535	(10.0) 8.5 - 11.0
024291	LT245/75R16	31X9.50R16	E	30.6	9.4	7.3	18.0	80	3,042	(7.0) 6.5 - 8.0
024295	LT235/85R16	32X9.00R16	E	31.8	9.7	6.9	18.0	80	3,042	(6.5) 6.0 - 7.5
024292	LT265/75R16	32X10.50R16	E	31.7	10.1	8.0	18.5	80	3,415	(7.5) 7.0 - 8.0
024326	LT255/85R16	33X10.00R16	E	32.8	10.2	8.2	18.5	80	3,415	(7.0) 6.5 - 8.0
024293	LT285/75R16	33X11.50R16	E	32.8	11.3	8.6	18.5	80	3,750	(8.0) 7.5 - 9.0
024313	LT305/70R16	33X12.50R16	E	33.0	12.0	9.7	19.0	65	3,525	(9.0) 8.0 - 9.5
024294	LT315/75R16	35X12.50R16	E	34.7	11.9	9.8	19.5	65	3,860	(8.5) 8.0 - 11.0
024297	LT265/70R17	32X10.50R17	E	31.7	10.8	8.4	18.5	80	3,195	(8.0) 7.0 - 8.5
024298	LT285/70R17	33X11.50R17	E	32.9	11.5	9.1	18.5	80	3,195	(8.5) 7.5 - 9.0
024315	LT305/65R17	33X12.50R17	E	32.8	12.3	9.9	19.5	65	3,195	(9.0) 8.5 - 11.0
024299	LT295/70R17	34X12.00R17	E	33.5	11.8	9.5	19.5	80	3,195	(8.5) 7.5 - 10.0
024316	LT315/70R17	35X12.50R17	D	34.5	12.8	10.0	19.5	50	3,195	(9.5) 8.0 - 11.0
024323	LT305/60R18	33X12.50R18	E	32.6	12.1	9.8	21.0	65	3,195	(9.0) 8.5 - 11.0
024322	LT295/70R18	34X12.00R18	E	34.3	12.0	9.6	18.5	80	4,080	(8.5) 7.5 - 10.0
024320	LT305/70R18	35X12.50R18	E	35.0	12.5	9.9	19.5	65	3,750	(9.0) 8.5 - 10.0
024321	LT305/55R20	33X12.50R20	E	33.3	12.5	10.1	19.5	65	3,195	(9.5) 8.5 - 11.0
024314	35X12.50R20LT	—	E	34.7	12.5	9.9	20.0	65	3,195	(10.0) 8.5 - 11.0

*ALL MAX LOAD DATA IS FOR SINGLE REAR TIRE APPLICATIONS.



TRAIL COUNTRY™

PART NO.	TIRE SIZE	EQUIVALENT SIZE	LOAD RANGE	O.D. INCHES	SEC. WIDTH INCHES	TREAD WIDTH INCHES	TREAD DEPTH 32NDS	MAX INFL. PSI	MAX LOAD* LB	(MEAS. RIM WIDTH) / APPROVED RIM WIDTH - INCHES
002023	30X9.50R15LT	—	C	29.3	9.6	7.3	16.5	50	1,985	(7.5) 6.5 - 8.5
002024	31X10.50R15LT	—	C	30.2	10.6	8.3	16.5	50	2,270	(8.5) 7.0 - 9.0
002025	LT225/75R16	29X8.50R16	E	29.3	8.5	7.0	16.5	80	2,680	(6.0) 6.0 - 7.0
002026	LT245/70R16	30X9.50R16	E	29.5	9.8	7.9	16.5	80	2,910	(7.0) 6.5 - 8.0
002028	LT245/75R16	31X9.50R16	E	30.4	9.7	7.5	16.5	80	3,042	(7.0) 6.5 - 8.0
002031	LT265/70R16	31X10.50R16	E	30.6	10.9	8.7	16.5	80	3,195	(8.0) 7.0 - 8.5
002046	265/75R16 †	32X10.50R16	STD	31.5	10.6	7.8	13.0	44	2,756	(7.5) 7.0 - 9.0
002033	LT265/75R16	32X10.50R16	E	31.5	10.6	8.3	16.5	80	3,415	(7.5) 7.0 - 8.0
002038	LT285/75R16	33X11.50R16	E	32.6	11.5	8.9	17.0	80	3,750	(8.0) 7.5 - 9.0
002040	245/65R17 †	30X9.50R17	STD	29.5	9.5	7.8	12.5	44	2,149	(7.0) 7.0 - 8.5
002041	255/65R17 †	30X10.00R17	STD	30.1	10.1	8.2	12.5	44	2,337	(7.5) 7.0 - 9.0
002043	265/65R17 †	31X10.50R17	STD	30.6	10.6	8.5	12.5	44	2,469	(8.0) 7.5 - 9.5
002030	LT265/65R17	31X10.50R17	E	30.5	10.7	8.7	16.0	80	3,085	(8.0) 7.5 - 9.5
002027	LT245/70R17	31X9.50R17	E	30.6	9.8	7.9	16.5	80	3,000	(7.0) 6.5 - 8.0
002029	LT245/75R17	32X9.50R17	E	31.5	10.0	7.6	16.0	80	3,195	(7.0) 6.5 - 7.5
002045	265/70R17 †	32X10.50R17	STD	31.4	10.7	8.3	13.0	44	2,679	(8.0) 7.0 - 9.0
002032	LT265/70R17	32X10.50R17	E	31.7	10.9	8.6	16.5	80	3,195	(8.0) 7.0 - 8.5
002037	LT285/70R17	33X11.50R17	E	32.8	11.6	9.1	17.0	80	3,195	(8.5) 7.5 - 9.0
002039	LT315/70R17	35X12.50R17	D	34.3	12.6	10.0	17.0	50	3,195	(9.5) 8.0 - 11.0
002042	265/60R18 †	31X10.50R18	STD	30.6	10.5	9.0	12.5	44	2,337	(8.0) 7.5 - 9.5
002044	265/65R18 †	32X10.50R18	STD	31.5	10.7	8.5	12.5	44	2,601	(8.0) 7.5 - 9.5
002034	LT275/65R18	32X11.00R18	E	32.1	11.1	8.9	16.0	80	3,415	(8.0) 7.5 - 9.5
002036	LT275/70R18	33X11.00R18	E	33.2	11.1	8.9	15.5	80	3,640	(8.0) 7.0 - 8.5
002047	275/55R20 †	32X11.00R20	XL	31.9	10.9	9.2	12.5	50	2,833	(8.5) 7.5 - 9.5
002048	275/60R20 †	33X11.00R20	STD	33.0	10.9	8.9	12.5	44	2,679	(8.0) 7.5 - 9.5
002035	LT275/65R20	34X11.00R20	E	34.2	11.0	8.9	16.0	80	3,750	(8.0) 7.5 - 9.5

*ALL MAX LOAD DATA IS FOR SINGLE REAR TIRE APPLICATIONS.

The TRAIL COUNTRY™ is a true all-terrain, M+S rated tire for light trucks and SUVs. This tire is engineered to be tough and reliable in a variety of conditions from street to off-road environments.

Offered in 26 popular sizes.

PRO COMP

NEW



A/T Sport

The all new Pro Comp A/T Sport can take you wherever you want to go. Rugged dependability is balanced with quiet on-road manners – and it's all backed with a 60-day trial and 60,000 mile warranty. The only limitation is your imagination.

Xterrain



For a set of rock crawling beasts that also drive comfortably on paved roads, Pro Comp Xterrain off-road truck tires provide all the aggressive traction that you need, and just might surprise you with their freakishly quiet ride on the street. They also feature an extra thick side wall construction for maximum durability and puncture resistance.

Xtreme MT/2



The Pro Comp Radial Xtreme M/T2 is one of the most advanced tires on and off the road--period. Each size features Tri-Ply construction for greater puncture resistance in the sidewall; while two steel belts and a spiral-wound nylon overwrap provides superior stability and load carrying ability at highway speeds. This ultra-modern mud tire features a unique tread compound that is coupled with silica, which enhances its ability to navigate anything from wet roads to slick rock to deep mud. The Pro Comp Xtreme M/T2 continues to set the performance standard required for modern 4x4s.



ATTURO

TRAIL BLADE M/T



The Atturo Trail Blade M/T is a performance mud terrain tire. The Trail Blade M/T was designed to provide a strong core with excellent traction all wrapped in an aggressive style.

TRAIL BLADE X/T



The innovative, new Atturo Trail Blade X/T offers rugged performance and amazing style in a new kind of all-terrain tire for owners of lifted vehicles and modified SUVs. Atturo now offers the aggressive sidewall style of our popular Trail Blade M/T combined with a tread designed for performance on the trail as well as on the road.

TRAIL BLADE A/T



The Trail Blade A/T provides a durable tread compound formulated for long life with deep sipes for all weather performance. It is constructed for truck owners who demand a strong tire with versatile traction capabilities, but at an affordable price level. The A/T offers true off-road capability with natural highway convenience.



Wheel Spacers

Spidertrax has been providing the off-road market with quality wheel spacers since 1999. With our vehicle specific designs, aluminum anodizing for critical corrosion resistance, and our unmatched competition tested no risk money back guarantee, it's easy to see why Spidertrax Wheel Spacers are the #1 choice among four-wheelers. All Spidertrax Wheel Spacer Kits come complete with two 6061T6 anodized aluminum wheel spacers, pre-installed wheel studs, lugnuts, and Loctite. Proudly manufactured in the United States of America.



Jeep® 1.5" Thick Wheel Spacers

These 1.5" thick, 5 on 4.5", 6061T6 aluminum spacers are an easy way of spacing out front and rear Jeep® XJ, YJ, TJ, ZJ, KJ and KK axles.
Part No. WHS020



Jeep® 1.75" Thick Wheel Spacers

These 1-3/4" thick, 5 on 5" bolt circle, 6061T6 aluminum spacers are an easy way of spacing out front and rear 2007-Present Jeep® Wrangler JK, 2006-Present Commander XK, and 05-10 Jeep® Grand Cherokee WK axles.
Part No. WHS021



07-Up JK to Wrangler Adapters

These 1-3/8" thick, 5 on 5" to 5 on 4-1/2", 6061T6 aluminum adapters make it possible to change your wheel bolt pattern. Simply install on a 2007 Jeep® Wrangler JK, 2006-Present Commander, or 2005-Present Jeep® Grand Cherokee WK axle and this adapter will convert your bolt pattern to the 86-06 Jeep® Wrangler YJ and TJ bolt circle.
Part No. WHS011



07-Up JK Wrangler Spacers

These 1-1/2" thick, 5 on 5" bolt circle, 6061T6 aluminum spacers are an easy way of spacing out front and rear 2007-Present Jeep® Wrangler JK, 2006-Present Commander, and 2005-Present Jeep® Grand Cherokee WK axles.
Part No. WHS010
Part No. WHS010K - Black



87-06 Jeep® Wrangler Spacers

These 1.25" thick, 5 on 5", 6061T6 aluminum spacers are an easy way of spacing out front and rear Jeep® XJ, YJ, TJ, ZJ, KJ and KK axles.
Part No. WHS002



Jeep® JK Conversion Adapters

We have heard your feedback and are happy to announce the Spidertrax 87-06 Wrangler to 2007-Up JK Wrangler Adapter Kit. With this adapter kit, you can now install new 5 on 5" Jeep® JK wheels onto your Jeep® XJ, YJ, TJ, ZJ, & Liberty. Each adapter is 1-1/4" thick.
Part No. WHS013



45-86 Jeep® CJ Spacers

These 1.25" 5 on 5.5" 6061T6 aluminum spacers are an easy way of spacing out front and rear Jeep® CJ axles.
Part No. WHS003



87-06 Wrangler to CJ Adapters

These 1.25" thick, 5 on 4.5" to 5 on 5.5", 6061T6 aluminum adapters now make it possible to change your wheel bolt circle! Simply install on an axle with a 4.5" bolt circle and this adapter will convert the axle to a 5.5" bolt circle.
Part No. WHS004



Jeep® WJ Wheel Spacers

These 1.25" thick, 5 on 5" 6061T6 aluminum spacers are an easy way of spacing out front and rear Jeep® WJ axles.
Part No. WHS006



Jeep® CJ Conversion Adapters

These 1-3/8" thick, 5 on 5" to 5 on 5-1/2", 6061T6 aluminum adapters make it possible to change your wheel bolt pattern. Simply install on a 2007-Present Jeep® Wrangler JK, 2006-Present Commander, 2005-Present Jeep® Grand Cherokee WK, or 19-04 Grand Cherokee axle and this adapter will convert your bolt pattern to the Jeep® CJ bolt circle.
Part No. WHS012



Jeep® WK2

These 1-3/4" thick, 5 on 5" bolt circle, 6061T6 aluminum spacers are an easy way of spacing out front and rear 2011-Up Jeep® Grand Cherokee WK2 axles.
Part No. WHS024

NEW



FLAT STYLE FLARES

AWARD WINNING DESIGN
 Recognized for excellence
TPO DURABILITY
 Sturdy and flexible – you won't get that with metal

Flat Style Flares



84-01 Jeep® Cherokee XJ



Flat Style Flares
 07-16 Jeep® Wrangler JK



Flat Style Flares
 97-06 Jeep® Wrangler TJ

Flat Style Fender Flares

Part No.	Application	T/C
1092207	84-01 Cherokee XJ (Not compatible with models that have had Cut-Out Flares previously installed)	Up to 4.50
1006307	84-01 Cherokee XJ (Not compatible with models that have had Cut-Out Flares previously installed)	4.50
1006407	84-01 Cherokee XJ (Not compatible with models that have had Cut-Out Flares previously installed)	3.25

Flat Style Fender Flares

Part No.	Application	T/C
1092407	87-95 Wrangler YJ (ex. Renegade)	6.00
1006707	87-95 Wrangler YJ (ex. Renegade)	6.00
1006807	87-95 Wrangler YJ (ex. Renegade)	6.00
1092007	97-06 Wrangler TJ	6.00
1005507	97-06 Wrangler TJ	6.00
1005607	97-06 Wrangler TJ	6.00
1091907	07-16 Wrangler JK 2-door Sport Utility	9.50
1091807	07-16 Wrangler JK 4-door Sport Utility	9.50



Hurricane Flat Fender Flares

- Fender flare's unique shape is built to complement the Wrangler's body
- Provides extra clearance for oversized wheels and tires
- Protects the vehicle's paint from flying rocks, mud and any other elements found outdoors

Part No.	Application
1164009	07-15 Wrangler JK - 2 and 4 Dr - with Side Marker Lights
1164010	07-15 Wrangler JK - 2 and 4 Dr



FENDER FLARES



Jeep® JK Tube Fenders

The ultimate in tube fenders for your Jeep® JK. These tube-style fender flares offer the maximum in body protection while providing clearance for a larger tire.

Part No.	Application
PJ4001	Jeep® TJ/LJ Rear Tube Fenders
PJ4020	Jeep® JK Front Tube Fenders
PJ4021	Jeep® JK Narrow Front Tube Fenders
PJ4025	Jeep® JK Rear Tube Fenders



Sport Style Fender Flares

- Xenon Sport Flares are made of a tough, durable, urethane
- Xenon Sport Flares are minimum 1/8" wall thickness and virtually unbreakable
- Flares fit flush to the fender exactly matching body contours
- Xenon's Sport Flares can be installed in their natural satin black finish or easily painted prior to installation
- Limited lifetime warranty

Part No.	Application
8870	07-16 Wrangler JK 2 Dr (1.5" wider than stock)
9010	07-16 Wrangler JK 4 Dr (1.5" wider than stock)
9070	97-06 Wrangler TJ 6"
9080	87-96 Wrangler YJ 6"
9103	07-16 Wrangler JK 2 Dr (1.5" less than stock)
9110	07-16 Wrangler JK 4 Dr (1.5" less than stock)
9190	97-06 Wrangler TJ 4"



XRC Fender Flares

100% steel construction for extra durability. Powder coated for immediate use and durability or they can be painted to color match your ride. Streamline designed to help increase suspension articulation while maintaining the street-ability look.



With Built-in Flares Part No.	Fender Only Part No.	Front Flares
76873	76872	Jeep® Wrangler 97-06
76863	76862	Jeep® Wrangler 87-95
76867	—	Jeep® CJ-7 76-86
SET Part No.	Flares Set	
76837	Wrangler, 07-14 (4 PCS)	
Rear Flares Part No.	Corner Guards Part No.	Rear Flares/ Corner Guards
76875	76874	Jeep® Wrangler 97-06
76877	76876	Jeep® Wrangler 87-95

LUND

Premium Style. Lasting Performance.

LUND Fender Flares are manufactured from 100% ABS plastic offering optimal performance, unparalleled durability, and superior protection from dirt and debris. Offered smooth or LUND's exclusive textured finish, our fender flares install easily without cutting or drilling.

Part No.	Application
FX606T	Flat Style - Textured Black with Steel Bolts
FX606S	Flat Style - Smooth Black with Steel Bolts
FX606SB	Flat Style - Smooth Black with Black Bolts
RX606T	Rivet Style - Textured Black with Steel Bolts
RX606S	Rivet Style - Smooth Black with Steel Bolts
RX606SB	Rivet Style - Smooth Black with Black Bolts

Fender Flares for 07-16 Jeep® Wrangler



WESTIN™ NEW

Sling Fender Flares

- Made of 12 gauge steel
- 1.5" diameter tube, .120" thick wall
- Front fender: 6-7/16" wide
- Rear fender: 4-7/8" wide
- Turn signal lights on front fenders
- Sold in pairs

Part No.	Year	Model	Position
621005	14-15	Wrangler	Front
621015	14-15	Wrangler	Rear



BLACK MOUNTAIN

Steel Fender Flares

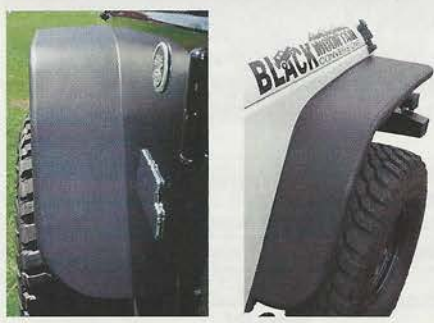

- Add style and protection to your JK Wrangler with these Black Mountain Steel Fender Flares
- Keeps your rig from road rash and mud splatter
- Get comprehensive protection and a rugged look
- Great looking and easy to install

Part No. BMFF4 - 07-16 Wrangler JK

RBP™ ROLLING BIG POWER™

Fender Armor

- Complete your off-road look
- No need to replace or buy expensive fenders or fender flares
- Works on stock fenders
- UV resistant, made from high impact plastic



Part No. 791483
07-16 Wrangler JK

Crown

Quality Replacement Parts
Est. 1983
For Jeep® Vehicles

Fender Flare Kit

See more Crown applications on page 140



Part No.	Application
5AHK	87-95 Wrangler YJ - 4 Piece Kit; Includes Hardware
55254918K7	97-06 Wrangler TJ - 4 Piece Set; Flat Black; 6-5/8" Wide
5KFK	11-15 Wrangler JK - 4 Piece Set; Includes Hardware

A Legend In Steel Since 1991

Part No. JKFL1502P



Jeep® Rear Cargo Packages



Jeep® Rocker Protection



Part No.	Application
JKSL1102P	JK Stubby Basic Front Winch Bumper
JKSL1202P	JK Stubby Winchguard Front Winch Bumper
JKSL1302P	JK Stubby Stinger Front Winch Bumper
JKSL1402P	JK Stubby Stinger/Hoop Front Winch Bumper
JKSL1502P	JK Stubby Fenderbar Front Winch Bumper
JKML1102P	JK Medium Basic Front Winch Bumper
JKML1202P	JK Medium Winchguard Front Winch Bumper
JKML1302P	JK Medium Fenderbar Front Winch Bumper
JKFL1302P	JK Fullsize Fenderbar Front Winch Bumper
JKFL1502P	JK Fullsize Euro-Style Front Winch Bumper
JKFSPP	JK Steel Front Skidplate
JKFSPA	JK Aluminum Front Skidplate
JR51102P	52" Basic Front Bumper (CJ, YJ, TJ)
JR51202P	52" Winch Guard Front Bumper (CJ, YJ, TJ)
JR51302P	52" Fenderbar Front Bumper (CJ, YJ, TJ)
JR51402P	52" Stinger Front Bumper (CJ, YJ, TJ)
JR61102P	60" Basic Front Bumper (CJ, YJ, TJ)
JR61202P	60" Winch Guard Front Bumper (CJ, YJ, TJ)
JR61302P	60" Fenderbar Front Bumper (CJ, YJ, TJ)XJ
JXJRTCP	XJ Rear Tire Carrier Bumper
JKRTCP	JK Rear Tire Carrier Bumper
TJRTCP	TJ/LJ Rear Tire Carrier Bumper

Rear Bumpers



Pure Jeep - Your Choice For Hardcore Jeep® Protection
Products Available For JK, TJ, YJ, CJ, XJ, ZJ, WJ, MJ

Part No.	Application
PJ1003	JK Bare Bonez Winch Mount Combo
PJ1004	JK Front Stubby Stinger Bumper
PJ1005	JK Front Stubby Grill Guard Hoop Stinger Bumper
PJ6000	JK Bolt-on D-Ring Shackle Mounts
PJ2002	JK Rear Stubby Tire Carrier w/Light Provisions
PJ3100	TJ Formed Rocker Skids
PJ3000	JK 2-Door Formed Rocker Guards
PJ3002	JK 4-Door Formed Rocker Guards
PJ4020	JK Front Tube Fenders
PJ4025	JK Rear Tube Fenders
PJ4000	TJ/LJ Front Tube Fenders
PJ4001	TJ Rear Tube Fenders
PJ5100	TJ/LJ Gas Tank Skid
PJ5101	TJ/LJ Steering Box Skid
PJ1070	JK Evap Canister Relocation Skidplate
PJ1080	JK Electronic Sway Bar Skidplate
PJ1086	JK Engine Skidplate '12-Up
PJ5155	JK Axle Complete Gusset/Skid Set Dana 44

Winch Mounts



Tube Fenders



Rocker Guards



Skid Plates

Total Jeep® Coverage - Made in the USA



Bestop
Fit. Function. Style.

Jeep® Bumpers Narrow Off-Road Style

- 3/16" laser-cut, stamped steel construction with E-coat, powder-coat and wrinkle finish for superior protection
- Ends are tapered for measuring extreme clearance
- TJ bumpers measure 35.5" wide x 9" deep x 5.5" high
- JK bumpers measure 41.5" wide x 11" deep x 8" high
- JK bumper has welded winch plate, TJ winch plate comes separately in kit
- JK bumper comes standard with pre-cut holes and molded plastic light cans to easily integrate OEM lights

Satin Finish

Part No. 4293001 — 04-06 TJ
Part No. 4293301 — 07-16 JK

Matte Finish

Part No. 4493001 — 04-06 TJ
Part No. 4493301 — 07-16 JK



HighRock 4x4™ Rear Bumper with Tire Carrier

- Same great 3/16" laser-cut stamped steel bumper construction with with E-coat, powder-coat and wrinkle finish for superior protection
- Tire Carrier arm mounts through bumper on Mega-Duty spindle, MIG-welded steel bracket with heim joints at tailgate
- TJ bumper measures 58" wide x 5" deep x 5" high
- JK bumper measures 72" wide x 5.5" deep x 10" high
- 1" thick D-ring attachment points
- Tire carrier can hold up to a 40" tire
- Brake light relocation bracket included
- Hi-Lift Jack and fire extinguisher mounts included

Satin Finish

Part No. 4293101 — 97-06 TJ
Part No. 4293401 — 07-16 JK

Matte Finish

Part No. 4493101 — 97-06 TJ
Part No. 4493401 — 07-16 JK

HighRock 4x4™ Front Bumper

- 3/16" laser-cut steel with E-coat and wrinkle finish powder-coat
- Optional Tubular Grille Guard protects both the grille and headlights, available in textured black or polished stainless steel
- No-drill installation
- D-ring ears standard
- Winch plate included
- Fits most popular 8000 lb. winches



Satin Part No.	Matte Part No.	Color Code	Application
42901	44901	01	97-06 HighRock 4x4™ Front Bumper Wrangler and Wrangler Unlimited
42910	44910	01	07-16 HighRock 4x4™ Front Bumper Wrangler and Wrangler Unlimited
42906	44906	01	97-06 HighRock 4x4™ Tubular Grille Guard Black; for all TJ Front Bumpers
42915	44915	01	07-16 HighRock 4x4™ Tubular Grille Guard Black; for all JK Front Bumpers
42906	—	00	97-06 HighRock 4x4™ Tubular Grille Guard Stainless steel; for TJ Front Bumpers
42915	—	00	07-16 HighRock 4x4™ Tubular Grille Guard Stainless steel; for JK Front Bumpers
42905	—	01	HighRock 4x4™ Approach/Departure Roller 2" Approach Roller, 24" wide Fits HighRock 4X4™ Front & Rear Bumpers



HighRock 4x4™ High Access Front Bumper

- Heavy-duty bumper with approach angles to get over and around the toughest obstacles.
- 3/16" laser-cut steel with E-coat and wrinkle finish powder-coat
 - Winch plate included
 - Fits most popular 8000 lb. winches

Satin Part No.	Matte Part No.	Color Code	Application
42917	44917	01	97-06 HighRock 4x4™ High Access Front Bumper Wrangler, TJ Wrangler will fit Rubicon models
42918	44918	01	07-16 HighRock 4x4™ High Access Front Bumper Wrangler, JK Wrangler will fit Rubicon models
42906	44906	01	97-06 HighRock 4x4™ Tubular Grille Guard Black; for all TJ Front Bumpers
42915	44915	01	07-16 HighRock 4x4™ Tubular Grille Guard Black; for all JK Front Bumpers
42906	—	00	97-06 HighRock 4x4™ Tubular Grille Guard Stainless steel; for TJ Front Bumpers
42915	—	00	07-16 HighRock 4x4™ Tubular Grill Guard Stainless steel; for JK Front Bumpers
42905	—	01	HighRock 4x4™ Approach/Departure Roller 2" Approach Roller, 24" wide Fits HighRock 4X4™ Front and Rear Bumpers

HighRock 4x4™ Rear Bumper

- 3/16" laser-cut steel with E-coat and wrinkle finish powder-coat
- Includes a Class 2.5 receiver hitch that accepts many popular 2" hitch mount accessories
- No-drill application



Warning - Do not exceed manufacturer's recommended towing capacity.

Satin Part No.	Color Code	Application
42911	01	HighRock 4x4™ Rear Bumper 07-16 Wrangler and Wrangler Unlimited, Includes Class 2.5 Hitch, D-Ring Mounts and eparture Roller Mount (D-Rings sold separately)
42921	00	HighRock 4x4™ D-Rings (Sold in pairs) Available in Silver
42922	01	HighRock 4x4™ Receiver Recovery Hitch Fits HighRock 4X4™ Rear Bumper 42902, 42903, 42911 (includes one D-Ring Shackles)

Color Code 00 - Stainless Steel, 01 - Textured Black.



Marksman Front Bumper

- Made of 7 gauge steel
- One-piece fully welded construction
- Aggressive chiseled design
- Fits most medium frame 8,000-12,000 lb. winches
- 1" thick HD shackle mounts
- Textured black finish

Part No. 950512JK5 - 07-16 JK Wrangler



Marksman Stinger Front Bumper

- Made of 7-gauge steel
- One-piece fully welded construction
- Aggressive chiseled design
- Pre-drilled for winch and fairlead mounting
- Bumper mounts directly to frame

Part No. 951512JKX5 - 07-16 JK Wrangler



Scope Stinger Front Bumper

- Made of 7 gauge steel
- Welded 2" tube stinger
- Textured black finish
- Fits most medium frame 8,000-12,000 lb. winches

Part No. 651512JKX5 - 07-16 JK Wrangler



Scope Bull Bar Front Bumper

- Made of 7 gauge steel
- Welded 2" diameter bull bar
- Bumper mounts directly to the frame
- Available in textured black finish

Part No. 652512JKB5 - 07-16 JK Wrangler



Scope Front Bumper

- Made of 7 gauge steel
- One-piece fully welded construction
- Bumper mounts directly to the frame
- Available in black textured finish
- Fits most medium frame 8,000-12,000 lb. winches

Part No. 650512JK5 - 07-16 JK Wrangler



Elite Series Rear Bumper

Built to Be More Durable

- Raised corners for increased departure angles and clearance
- Laser-cut and CNC- formed steel construction
- Sand blasted prior to powder coating for increased coating durability
- Welded eyelets for D-shackles and a cutout for the factory hitch
- Accommodates up to a 40" spare tire

Part No. 89525 – 07-16 Wrangler JK

Tire Carrier

Re-Engineered to Be Easier to Use

- Tailgate-synchronized swing-out design
- Chassis-mounted pivot takes the weight off of the tailgate
- Easily opened with one hand
- Unique anti-vibration design keeps things quiet on and off the trail

Part No. 89800 - Must Be Used With Elite Series Rear Bumper #89525

Front Bumper Designed for Life Off-Road

Whether you're planning an overland expedition or just out exploring, these bumpers are designed for life off road. Features include a low, recessed winch mount for the ultimate winch protection, and a wrap-around design that offers strength and style. There are recessed ports and mounts for auxiliary lights, and a welded-on CNC-formed grille tube for increased protection (optional). There are recessed jack points for increased recovery options, and eyelets for D-shackles. Mounting fasteners are hidden inside the bumper for a clean finish and reduced corrosion. This is the ultimate bumper for those who are looking for versatility, capability, and protection.

- Recessed winch mount accepts all WARN mid-frame winches 12,000 lbs. capacity and under (excluding M8274-50)
- Recessed light ports and mounts for auxiliary lights (lights sold separately)
- Laser cut and CNC-formed steel construction
- Available with and without welded-on, CNC-formed grille tube
- Recessed jack points for more stable jack positioning
- Sand blasted prior to powder-coat for increased coating durability
- Mounting fasteners hidden inside for clean finish and reduced fastener corrosion

Part No. 87750 – 07-16 Wrangler JK With Grille Guard Tube

Part No. 87775 – 07-16 Wrangler JK Without Grille Guard Tube

Rock Crawler Stubby Bumper for the Jeep® JK & TJ Wrangler

- Narrower version of the popular Rock Crawler Bumper —designed for serious rock crawling
- Includes a winch mount that accepts all WARN mid-frame winches 12,000 lbs. capacity and under (excluding M8274-50 winch)
- Laser-cut and CNC- formed for durability, these bumpers have eyelets for D-shackles and recessed mounting hardware for a clean finish and reduced fastener corrosion
- Black powder-coated finish
- Recessed jack points for increased recovery options
- Recessed ports and mounts for auxiliary lights — including factory lights
- JK bumper also available with welded-on CNC-formed grille tube provides increased front-end protection

Rock Crawler Stubby Bumper for Jeep® JK

Part No. 87650 – without grille guard tube

Part No. 87600 – with grille guard tube

Rock Crawler Stubby Bumper for Jeep® TJ

Part No. 87700

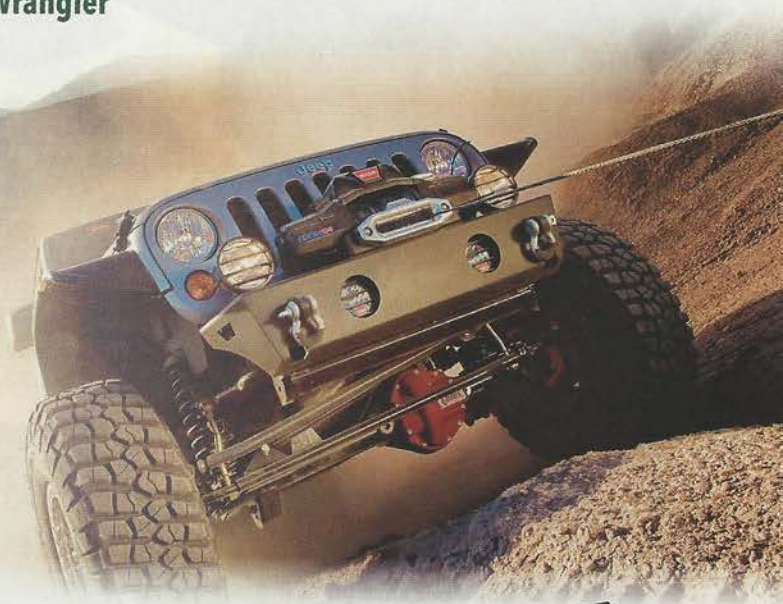

Steering Box Skid Plate for the Jeep® Wrangler

Part No. 64250 – 97-06 Jeep® Wrangler TJ

Fuel Tank Skid Plate for the Jeep® Wrangler

Part No. 67820 – 97-06 Jeep® TJ Wrangler

Part No. 66550 – 87-96 Jeep® YJ Wrangler



Oil Pan Skid Plate for the Jeep® TJ Wrangler

Part No. 65020 – Jeep® '97-03 TJ
(6-cylinder. Excludes Rubicon and Unlimited models)





Grille Guard Tube for the Rock Crawler Bumper

This tube wraps your WARN winch with rugged, tubular steel tilted at an optimum 20-degree angle. The black powder-coated finish combines durability with aggressive good looks. Designed to bolt on to the WARN Rock Crawler bumper or winch mounting plate, depending on application.

Part No.	Application
89440	07-15 JK
61855	97-06 Wrangler TJ (Includes Rubicon & Unlimited)
61858	86-95 Wrangler YJ
61861	86 & Prior CJ, Scrambler

WARN Rock Crawler Front Bumper for the Jeep® Wrangler JK, TJ, YJ, and CJ

The WARN Rock Crawler Bumper incorporates our off-road experience to deliver a tough, durable well thought-out product. Ends are tapered for increased approach angles. The bumpers have welded eyelets to mount D-shackles and pre-drilled holes to mount lights. Available for Jeep® brand CJs, YJs, and TJs, the WARN bumpers are laser cut from heavy 3/16" steel, then CNC formed and robotic-welded for precise fit and powder-coated for durability. (Not rated for tow bar use.)

- Part No. 61853 – 97-06 Wrangler TJ (Includes Rubicon and Unlimited)
- Part No. 89430 – 07-16 JK
- Part No. 61856 – 86-96 Wrangler, YJ
- Part No. 61859 – 76-86 CJ

WARN Rock Crawler Rear Bumper for the Jeep® Wrangler JK, TJ, YJ, and CJ

This tough, durable bumper gives maximum off-road performance. Tapered ends allow for increased departure angles. An integrated 2" receiver allows mounting of your portable winch or shackle bracket to increase your recovery options. (Not rated for towing.)

For carrying the oversize tires that serious off-roaders require, the rear bumper is available in a version that is designed to accept the WARN tire carrier.



Accepts Tire Carrier	Will Not Accept Tire Carrier	
Part No.	Part No.	Application
65508	61854	97-06 Wrangler TJ
74300	–	07-15 JK
65509	61857	87-95 Wrangler YJ
62947	61860	76-86 CJ 7



Winch Mounting Plates for the Rock Crawler Bumper

- Part No. 37170 – 98-06 Wrangler TJ
- Part No. 21390 – 86-95 Wrangler YJ and '91-91 Renegade
- Part No. 13910 – 86 & Prior CJ, Scrambler

WARN Rock Sliders for the Jeep® Wrangler

How many body shots can your Jeep® absorb? A heckuva lot more with WARN Rock Sliders. The thick steel plate construction and black powder-coat finish ensure durability. The plate bolts right to the Jeep® body, reinforcing its weakest spot. Mounting hardware is included. Some drilling required.

- Part No. 63002 – 97-02 TJ
- Part No. 63003 – 87-95 YJ
- Part No. 63004 – 76-86 CJ7
- Part No. 74580 – 07-14 JK, two door
- Part No. 74575 – 07-14 JK, four door
- Part No. 69875 – 05-06 TJ Unlimited

Tire Carrier

For carrying the oversize tires that serious off-roaders require, the rear bumper is available in a version that is designed to accept the WARN Tire Carrier. Built to carry heavier tires (up to 37"), the tire carrier pivots on a beefy 1-1/2" solid steel shaft pin, which comes up from within the bumper into the frame of the tire carrier. The shaft itself is welded, not bolted. Structural T-joint welds (vs. corner welds) mean the bumper holds up in the long run. Period. A polyurethane pad reduces rattling. Includes frame reinforcing brackets. Bumper sold separately.

- Part No. 63253 – For use with Part No. 62947
- Part No. 64337 – For use with Part No. 65508/65509
- Part No. 74299 – For use with Part No. 74300





SRC Bumpers

Just like the front, each rear bumper has a 3/16" solid plate center section which is designed to contour around an oversized tire to give you the maximum tire clearance when opening and closing your tailgate. Each rear bumper features a class III, 2" receiver hitch that is incorporated into the bumper and bolts directly up to your O.E. Points. Includes two D-Ring mounts for those sticky situations.

Part No.	JEEP® WRANGLER/JK
76723	07-15 SRC Front Bumper
76612	07-15 SRC Rear Bumper
76622	07-15 SRC Rear Bumper with Tire Carrier
76721	87-06 SRC Front Bumper
76611	87-06 SRC Rear Bumper
76621	87-06 SRC Rear/ Tire Carrier
2812	CJ Adapter Front Bumper



SRC GEN2 Bumpers and Rear Tire Carrier

The new Smittybilt SRC front bumper has been completely redesigned with more aggressive styling and heavy duty features. The new bumper features an integrated over-rider bar and corners that extend to match the factory fender line for greater protection. The redesigned solid D-ring mounts feature an integrated recovery point for easy access. The winch plate has been placed lower for greater airflow to the radiator.

New GEN2 Solid D-Ring and Jack Point



Part No.	JEEP® WRANGLER JK
76724	07-15 Gen2 Front Bumper
76614	07-15 Gen2 Rear Bumper
76857	Gen2 Bolt-On Tire Carrier

SRC Classic Bumpers

The SRC classic line provides style and strong characteristics to the front of your Jeep®. All of our classic bumpers have the proper approach angles which are needed in the rock crawling world. Each bumper is manufactured from 3/16" plate and will provide you the maximum protection for any situation that you can get yourself into.

Bumper	W/Winch Plate	CLASSIC FRONT BUMPER
76741	76743	Wrangler (JK) 07-15
2-DOOR	4-DOOR	CLASSIC SIDE PROTECTION
76635	76636	Wrangler (JK) 07-15
NO D-RING	D-RING	CLASSIC FRONT BUMPER
76740	76740D*	Wrangler 76-06
NO D-RING	D-RING	CLASSIC REAR BUMPER
76750	76750D*	Wrangler 76-06
NO D-RING	D-RING	CLASSIC REAR BUMPER W/ TIRE CARRIER
76651	76651D*	Wrangler 76-06
2-DOOR	4-DOOR	CLASSIC SIDE W/STEP
76638	76639	Wrangler (JK) 07-15

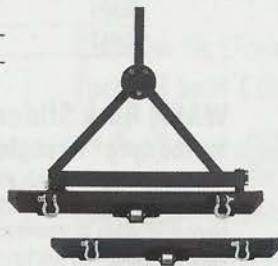

Heavy-duty latch mechanism



Three point mounting for oversized spare tire



Custom grease fitting keeps hinge clean



Optional D-Rings



Attaches to front frame horns and lower cross member



Classic bumper without winch



Classic Rock Crawler design provides front end protection



Swing away allowing the use of your tailgate



SRC Front Stinger Bumper

Part No.	JEEP® WRANGLER/JK
76521	87-06 Front Bumper
76524	07-15 Front Bumper

Tire Relocation Bracket

Part No.	JEEP® WRANGLER/JK
3721	76-15 Tire Relocation Bracket

SRC - Side Armor/Guards

Side Armor Part No.	Rocker Guards Part No.	Rocker w/Plate Part No.	Applications
A	B		
76631	76641	-	Wrangler 87-06
76632	76642	-	Unlimited 04-06
C	D	E	
76633	76643	76645	Wrangler 2-DR 07-15
76634	76644	76646	Unlimited 4-DR 07-15

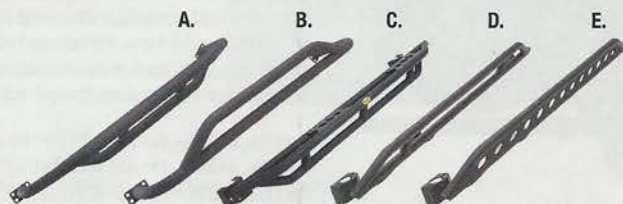



XRC Rear Bumpers

Part No.	Jeep® Wrangler JK
76806	07-15 Front Bumper
76855	07-15 Rear Bumper
76856	07-15 Rear Bumper with Tire Carrier
Part No.	Jeep® Wrangler / CJ
76800	97-06 Front Bumper
76801	87-95 Front Bumper
76653	87-06 Rear Bumper
76654	87-06 Rear Sway Away
2812	CJ Adapter Front Bumper

Part No. 76653/76654



XRC Gen2 Bumpers And Rear Tire Carrier

The new Smittybilt XRC front bumper has been completely redesigned with more aggressive styling and heavy duty features. The new bumper features an integrated over-ride bar and corners that extend to match the factory fender line for greater protection. The redesigned solid D-ring mounts feature an integrated recovery point for easy access. The winch plate has been placed lower for greater airflow to the radiator.



Front and Rear Bumpers

- Innovative 3 piece design. Marine grade stainless steel hardware
- Lower design winch plate allowing greater air flow
- Two stage textured matte black finish
- Bolt-on skid plate
- Reuses OE fog light
- Manufactured from 3/16" cold rolled steel



Part No.	Jeep® Wrangler JK
76892	07-15 Front Bumper
76896	07-15 Rear Bumper with Tire Carrier
76888	07-15 Rock Sliders 2DR (with step)
76889	07-15 Rock Sliders 4DR (with step)

Part No.	Application
76807	07-15 Gen2 Front Bumper
76858	07-15 Gen2 Rear Bumper
76857	Gen2 Bolt-On Tire Carrier

Front Mod Bumpers

High-Angle Design

Side Angle Support



Full Width End Plate

Mid Width End Plate



Modular Stinger

Modular Bull Bar



XRC Tubular Doors

Part No.	Applications
76791	Jeep® 07-15 (JK) - 2/4 Door Front - Blk
76792	Jeep® 07-15 (JK) - 4 Door Rear - Blk
76793	Jeep® 97-06 (TJ/LJ) Front - Blk

Mirror relocation brackets included

Body Armor Skins

- Maximum protection with 1/8" cold-rolled steel
- Contours perfectly to the OE panels
- Retains ability to have stock fenders bolted back on
- Two-stage textured matte black finish
- Drilling required - all hardware included
- Sold as pairs

NEW

Part No.	Application
76980	07-15 Front - JK 2/4-Door
76981	07-15 Rear - JK 2-Door
76982	07-15 Rear - JK 4-Door



8
CONFIGURATIONS

Mid Width Wing
Perfect For Trail
Protection



XRC M.O.D. System (Wrangler JK)

Part No.	Year	Description
76825	07-15	Modular Center Section
76826	07-15	Mid Width End Plates
76827	07-15	Modular Stinger
76828	07-15	Full Width End Plates
76829	07-15	Modular Bull Bar
76830	07-15	Crawler End Plates

XRC Front And Rear Armor

Part No.	Applications	Location
76880	Jeep® JK, 07-15 2/4-Dr	Front Fenders
76881	Jeep® JK, 07-15 2-Dr	Corner Guards
76882	Jeep® JK, 07-15 4-Dr	Corner Guards
76886	Jeep® JK, 07-15 2-Dr	Body Cladding
76887	Jeep® JK, 07-15 4-Dr	Body Cladding



Steel Winch Mount Stubby Bumper

07-16 Jeep® Wrangler

Ready for Paint

- 3/16" Thick steel plate construction
- Hand welded and ground for quality
- Precision laser cut and CNC press brake formed
- Bolts directly into factory location and no need for cutting, drilling or welding
- Stubby design maximizes tire clearance and approach angles
- Tapered design easily slides off large rocks and ledges
- Available in Textured Wrinkle Black Or, Gloss Black Powder Coat and Raw finish

Part No.	Application
83233	Without Grill Guard; With Recessed/ Offset Winch Mount
83234	Without Grill Guard; With Recessed Winch Mount
83235	Full Width; without Grill Guard; With Winch Mount without Fairlead
83236	Full Width; without Grill Guard; With Top Winch Mount And Fairlead
83237	Full Width; without Grill Guard; With Recessed/ Offset Winch Mount
83238	Full Width; without Grill Guard; With Recessed Winch Mount

Add BB to Part No. for Black Powder Coat Finish.
R for Raw Finish.

Rock Doors and Accessories

- Designed to enhance your off road experience by increasing your visibility of trail obstacles
- Stylish and rugged tubular design
- Solid full loop construction
- Latch kit included
- Includes OR-Fab exclusive "Gecko" nylon pad kit with inner zipper map pouch
- No drilling, uses factory hinges



Mirror Relocation Brackets

- Easily relocate your factory JK mirrors to your OR-Fab Rock Doors, *Part No. 88002
- Made from 10 Gauge steel
- No Drilling Required

Part No.	Year	Application
88002*	07-16	07-15 ORF Front Rock Door Kit, JK
88003	07-16	07-15 ORF Rear Rock Door Kit, JK
88000	97-06	97-06 ORF Rock Doors, TJ
88001	80-86	80-86 ORF Rock Doors, YJ and CJ
87025	07-16	*JK Mirror Relocation Brackets to ORF doors

*JK Mirror Relocation Brackets to ORF doors

Rock Rails



An easy bolt-on, our rock slider sidebars and rocker panels protect rocker panels without sacrificing ground clearance. Constructed of extra heavy-duty 140-wall steel with a gloss black powder-coat finish, these are designed with the rock crawler in mind.

Part No.	Year	Application
84207	07-16	Rocker Panel with Bar, JK Wrangler 2-Door
84307	07-16	Rocker Panel with Bar, JK Unlimited 4-Door
84204	04-06	Rocker Panel (Pair) TJL Ext
84100	97-06	Rock Slider Side Bar TJ
84201	97-04	Rock Slider Rocker Protectors W/ Rail Bar TJ
84200	97-06	Rocker Panel S1 (Pair) TJ
84095	87-95	Rock Slider Side Bar YJ
84460	84-01	Jeep® Cherokee XJ Rock Slider Rails

Bumpers and Accessories

Our front bumper allows for extreme approach and departure angles, and can be used as a high lift jacking point as required. It won't block your oversized tires, but still protects the front fenders. Front bumpers will accommodate up to four off-road lamps and most aftermarket winches. Our rear bumper is a close, body-wrapping fit that protects the lower rear quarters and accepts a 2" clevis hook. Bumpers are constructed of extra heavy-duty 0.140-wall steel with a gloss black powder-coat finish.

Part No.	Year	Application
83204	07-16	ORF Front Bumper, OE Light Brackets, D-Ring Mounts, JK, 2/4 Dr
83205	07-16	Rock Slider Rear Bumper Jeep® JK, 2 and 4 Door
83208	07-16	Rear Bumper, Sheetmetal Jeep® JK, 2/4 Door
83210*	07-16	Front Stinger Bumper, Jeep® JK
83211*	07-16	Front Stinger Bumper, Jeep® JK, Offset Winch Mount
83212*	07-16	Front Stinger Non Winch OE Fog Light Bumper
83218	07-16	JK Sheet Metal Rear Bumper with LED Backup Lights
83220	07-16	Front Stubby Bumper, Jeep® JK Wrangler, Center Winch Mount
83221*	07-16	Front Stubby Bumper, Jeep® JK Wrangler, Offset Winch Mount
83222*	07-16	Front Winch Bumper with Hoop, (Centered Fairlead)
83223*	07-16	Front Winch Bumper with Hoop (Offset Fairlead)
83224	07-16	JK Hoop Non Winch Fog Light Front Bumper
83225	07-16	JK Full Width Bumper with Hoop For OEM Lights



Part No. 83223



Part No. 83218

Part No.	Year	Application
83226	07-16	JK Top Winch Mnt Full Width Bumper with Hoop For OEM Lights
83227	07-16	JK Full Width Offset Winch Bumper with Hoop For OEM Lights
83228	07-16	JK Full Width Winch Bumper with Hoop For OEM Lights
83229	07-16	JK Mid Width Offset Winch Bumper with Hoop For OEM Lights
83230	07-16	JK Mid Width Winch Bumper with Hoop For OEM Lights
83234	07-16	JK Mid Width Winch Bumper For OEM Lights
83235	07-16	JK Full Width Bumper For OEM Lights
83236	07-16	JK Top Winch Mnt Full Width Bumper For OEM Lights
83237	07-16	JK Full Width Offset Winch Bumper For OEM Lights
83238	07-16	JK Full Width Winch Bumper For OEM Lights
83640	97-06	Rear Rockslider Sheet Metal Bumper 92-06 Wrangler TJ/TJL
83661	97-06	TJ Front Winch Bumper with Hoop
83662	97-06	TJ Front Winch Bumper with Stinger
83760	97-06	TJ Front HD Bumper with Out Fairlead
83200	97-06	Rock Slider Front Bumper (97-05 TJ And 04/05 TJL)
83201	97-06	Rock Slider Front Bumper with Grill Guard 97-05 TJ 04/05 TJL
83240	84-01	Jeep® Cherokee XJ Front HD Bumper with Hoop
83241	84-01	Jeep® Cherokee XJ Front HD Bumper
83245	84-01	XJ Cherokee Rear "Comp Cut" HD Bumper
83250	84-01	XJ Cherokee Rear HD Bumper
83209	84-01	Rear Tube Bumper, Jeep® XJ
83096	87-95	Rock Slider Front Bumper YJ With Grill Guard
83100	80-06	Rock Slider Rear Bumper CJ, YJ, TJ and TJL

*Requires vacuum pump relocation kit for bumper installation, Part No. 87046

Jeep® is a registered trademark of FCA US LLC. More Applications Available.



Body Quarter Armor

- Constructed from 3/16" Steel Plate
- Designed to protect without reducing your ground clearance
- Laser Cut for precision fit
- Personalize the look of your Jeep®



Part No.	Year	Application
84330	07-16	JK 2 Door Rear Quarter Armor with Maxxima Lamp
84331	07-16	JK 2 Door Rear Quarter Armor No Lamp (Raw Steel)
84332	07-16	JK 2 Door Rear Quarter Slider Armor Maxxima Lamp
84340	07-16	JK 4 Door Rear Quarter Armor with Maxxima Lamp
84341	07-16	JK 4 Door Rear Quarter Armor No Lamp (Raw Steel)
84342	07-16	JK 4 Door Rear Quarter Armor with Rail and Maxxima Lamp
84400	84-01	Jeep® Cherokee XJ Quarter Armor
84450	84-01	Jeep® Cherokee XJ Quarter Armor with Rail

Add BB to Part No. for Black Powder Coat Finish
R for Raw Finish

Raw Finish Available

Ready to Paint

Rocker Side Armor

- Constructed from 3/16" Steel Plate
- Designed to protect without reducing your ground clearance
- Laser cut for precision fit
- Personalize the look of your Jeep®

Raw Finish Available

Part No.	Year	Application
84310	07-16	Rocker Side Armor Wrangler JK 2-Door
84320	07-16	07-15 Rocker Side Armor Wrangler JK 4-Door

Add BB to Part No. for Black Powder Coat Finish
R for Raw Finish

Vacuum Pump Relocation Kit

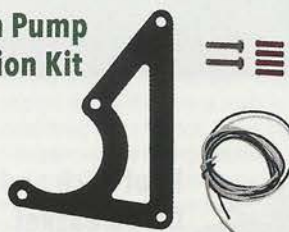

- 10 gauge steel construction
- Made in the U.S.A.
- Relocates vacuum pump to engine bay, keeping pump out of the elements
- Allows installation of aftermarket bumpers with built in winch mounts JK

Part No. 87046 - 12-15 Wrangler JK

Swing-Away Tire/Can Carriers

- Lightweight swing-way cage design fits closer to the body
- Made from strong 1.5" diameter .120-wall tubing
- Made in the USA
- Unique inner fender brace and strike plate mount create a solid foundation for vibration and noise-free operation
- Fits two standard size Jerry style canisters
- Lockable spin-mount fits factory or aftermarket wheels



Part No.	Year	Application
85207	07-16	Wrangler JK 2/4 Door
85209	07-16	Wrangler JK 2/4 Door with 2 Rotopax™ Fuel Cans
85201	97-06	Wrangler TJ/Unlimited
85095	87-95	Wrangler YJ
85208	07-16	Wrangler JK 2/4 Door, Non Canister
86201	97-06	Wrangler TJ/Unlimited
86095	87-95	Wrangler YJ
87017	—	Jeep® Third Brake Light mount for OR-Fab Swing Away Spare Tire Carriers

Add BB to Part No. for Black Powder Coat Finish
R for Raw Finish

Windshield Light Mount System

- Mounts to the factory A-pillar using OEM bolts
- Mount up to 5 8" lights or a 60" LED light bar
- Will not interfere with OEM or aftermarket tops
- Made in the USA
- Includes all necessary mounting hardware
- Lights not included

Part No. 87024
Windshield Light Mount, 07-16 Wrangler JK, Wrinkle Black
Part No. 87024BB
Windshield Light Mount, 07-16 Wrangler JK, Gloss Black





NEW

Bull Bar Winch Bumper for JK

- Accommodates a pair of flush 2x2 LED lights
- Provision for 20" single-row LED light bar
- Integrated winch tray and D-ring mounts
- Stylish on road, and functional on the trail
- Includes blank plates, lights sold separately



Part No. J031T

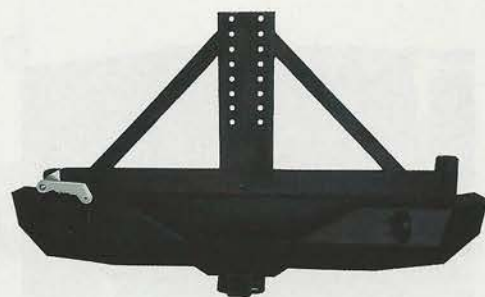

Rear Bumper With Tire Carrier

- Includes 2" receiver hitch
- Provisions for pair of 2x2 LED lights, sold separately

Part No. J032T



Roof Rack and Cargo Basket Black

- Part No. J018T - 87-95 Wrangler YJ
- Part No. J019T - 97-06 Wrangler TJ
- Part No. J029T - 07-15 Wrangler JK 4 Door
- Part No. J021T - 07-15 Wrangler JK 2 Door
- Part No. J022T - 04-06 Unlimited
- Part No. J023T - Cargo Basket (Universal)



Taillight Guards

- Rugged, fully welded design for extra strength
- Durable powder-coated finish
- Easy, bolt-on installation

- Part No. J015T - 07-15 Wrangler JK, Flat Design
- Part No. J026T - 07-15 Wrangler JK, Wraparound Design
- Part No. T0015B - 05-10 Grand Cherokee, Black
- Part No. T0004B - 08-11 Liberty, Black

Rock Crawler Side Armor

- Heavy-duty 2" x 0.120" construction with a durable powder coated finish
- Rugged, fully welded design for extra strength



- Part No. J025T - 07-16 Wrangler JK 2 Door
- Part No. J024T - 07-16 Wrangler JK 4 Door
- Part No. J008T - 04-06 Wrangler Unlimited
- Part No. J007T - 87-06 Wrangler

Rock Crawler Rocker Guards

- Rugged, fully welded design for extra strength
- Upper tube for side protection
- Heavy-duty 2" x 0.120" construction with a durable powder coated finish



- Part No. J028T - 07-16 Wrangler JK 2 Door
- Part No. J027T - 07-16 Wrangler JK 4 Door
- Part No. J004T - 04-06 Wrangler Unlimited
- Part No. J003T - 87-06 Wrangler

Rock Crawler Rear Bumpers

The Rock Crawler Rear Bumper Provides A Tough And Durable Bumper System

- Rock Crawler classic rear bumper
- Rear bumper incorporates 2" receiver hitch
- Heavy-duty 1/4" thick steel plate design
- Heavy-duty 2" x 0.120" construction with a durable powder coated finish
- Rugged, fully welded design for extra strength

- Part No. J012T - 07-16 Wrangler JK, Textured Black Tube, Without Tire Carrier
- Part No. J011T - 87-06 Wrangler, Textured Black Tube, Without Tire Carrier
- Part No. J013T - 87-06 Wrangler, Textured Black Tube, With Tire Carrier
- Part No. J014T - 87-06 Wrangler, Textured Black, Classic Design, With Tire Carrier



Tube Design



Classic Design



4X4 ACCESSORIES

Deluxe Bull Bar and Winch Bumpers

- Completely replaces the factory bumper
- Aimed at making remote area travel safe
- Maintains an optimum approach angle

Part No.	Application
3450220 ^{1,2}	07-15 Wrangler JK, Winch Bumper
3450400	07-15 Wrangler JK, Stubby Bumper
3450210	07-15 Wrangler JK, Rock Bar
3450240	07-15 Wrangler JK, Deluxe Bar With Grill Guard, Satin, Without Tow Hooks Or D Ring
3450230	07-15 Wrangler JK, Deluxe Bar With Grill Guard, Textured Black, Without Tow Hooks Or D Ring Mounts
3450250	07-15 Wrangler JK, Deluxe Bar With Grill Guard, Textured Black, With D Ring Mounts
3450070	97-06 Wrangler TJ/Unlimited, Winch Bar
3450100 ^{1A}	99-04 Grand Cherokee WJ, Combination Bar
3450410 ^{1B, 2B, 3B}	11-13 Grand Cherokee Deluxe Bar

1. If not fitting factory fog lamps, order Part No. 3550030 (fog light insert cover) to complete installation
 2. If not fitting winch, order Part No. 3550040 (top pan cover) to complete installation
 1A. Important: Fitment of bull bar to 99-00 WJ requires upgrade to hydraulic cooling system from later model
 1B. Optional fog light kit Part No. 6621201 available. harness required if vehicle not fitted with factory fog lights
 2B. Additional Fitting kit Part No. 550100 required when fitting bumper to vehicle equipped with factory parking sensors
 3B. Winch install kit Part No. 3540050 required when fitting winch

Rock Sliders



Bring on the rocks! These ARB rock sliders are manufactured from tough, tubular steel making them ideal for steep, rocky terrain. Will help reduce this damage, while at the same time improve access to your truck. The manufacturing process utilizes steel tube formed into shape using an internal mandrel bender, ensuring consistency and even wall thickness across all sections.

Part No.	Application
4450200	07-15 Wrangler JK, 2 DR
4450210	07-15 Wrangler JK, 4 DR
4450010 ¹	97-06 Wrangler TJ, TJ Unlimited

¹ Fits short wheel base model only

Rear Protection Bumpers

Designed for maximum functionality including a recessed bumper section, dual hi-lift jacking points and a heavy duty towing system. Recess in bumper to allow fitment of most oversized tires.

- Dual Hi-Lift jacking points
- Low slip tread plate-easy access to cargo
- Area through center recess
- Durable black powdercoat finish
- Compatible with factory tow package
- Integrated tow points

Part No.	Application
5650200 ^{1,2,3}	07-15 Wrangler JK, Recovery Points, Black
5650350 ^{3,4}	07-15 Wrangler JK, Optional Tire Carrier ⁴ , Recovery Points, Black
5750300 ^{4,5}	07-15 Wrangler JK, Optional Spare Tire Carrier
5650360	07-15 Wrangler JK, Textured
5750320 ^{4,5,7}	07-15 Wrangler JK, Textured
8161	Optional IpF Reverse Light
5650010 ^{1A, 2A}	97-06 Wrangler TJ/Unlimited, Hitch, D-Shackle Provisions, Black
5750012 ^{1A, 2A}	Swing-Out Wheel Carrier, Black

1. Non Swing Out, Tire Mounts in Factory Position
 2. Accommodates Up to a 35" Tire
 3. Utilizes Factory Tow Package
 4. Optional spare tire carrier Part No. 5750300 will only work in combination with bumper Part No. 5650350
 5. Will work with up to a 37" tire. Modification to 3rd brake light may be required to fit 37" spare tire.
 1A. Rear bar and wheel carrier must be purchased together for proper installation
 2A. Rear bar has built in tow hitch, but does not come with ball and mount for towing. Uses standard 2" receiver and ball available at most auto parts stores





Off-The-Door Tire Carrier



- First ever "5-Point" Off-The-Door Tire Carrier
 - Heavy duty custom machined and plated pivot shaft in double shear fabricated mount
 - Double turnbuckle at the top and bottom to eliminate any rotational vibration
 - Will handle up to a 40" tire. Max tire height when adding the optional third brake light for Off-The-Door Tire Carrier is 38"
- Part No. JK07Y12511** - Jeep® JK Rear Base Bumper (No Tire Carrier)
Part No. PY1261T1 - JK Off-The-Door Tire Carrier (Needs Base Bumper)
Part No. M20501 - JK 3rd Brake Light (Needs **Part No. JPY1261T1**)
Part No. M21501 - JK Hi-Lift Mount (Needs **Part No. JPY1261T1**)



Vengeance Series

- Overall design and fit is "high and tight" to the contours of the vehicle
- Sensor compatible and lightweight
- Allows for an integrated 20" LED light bar in the center
- Lower cut-out to provide airflow to intercoolers



Part No.	Year	Application
JK07D18511	07-16	JK - No Guard
JK07D18521	07-16	JK - Pre-Runner Guard
JK07D18531	07-16	JK - Stinger



Full Metal Jacket Bumper

07-15 Jeep® Wrangler JK

- (Fits other winches as well)
- Bumper and Winch Modifier accepts 2x2 Rigid Industries "Dually" lights (Bumper fits Factory Fogs).
- Bumper Does not include 2x2 Rigid Industries lights or Fab Fours lights
- Styling features enhance the new Warn "Zeon" Winches

- Part No. JK07B18551** - JK FMJ Stubby Winch Bumper
Part No. JK07B18561 - JK FMJ Stubby Winch Bumper with Grill Guard
Part No. JK07B18591 - JK FMJ Winch Bumper Modifier
Part No. JPWP1 - Jeep® JK Winch Plate
Part No. JK07B18571 - JK Full Width With No Guard
Part No. JK07B18581 - JK Full Width With Guard
(Required if using a winch without FMJ Modifier)



"Stubby" Winch Bumper

- Hi-Lift Jack points
- 3/4" D-ring mounts
- "Stubby" Design for maximum tire clearance
- 3/16" Steel Construction
- Winch mount for a 10,000 lb winch or smaller, including the WARN PowerPlant
- Light cutouts for factory fog lights
- Optional - 90mm Fab Fours fog light kit (**Part No. JKSTLA**)

- Part No. JK07B18531** - 07-15 Wrangler JK, Without Grille Guard
Part No. JK07B18541 - 07-15 Wrangler JK, With Grille Guard



Lifestyle Winch Bumper

A stylish, high-clearance winch bumper with integrated D-Ring mounts and lights. Design is focused on its strength and rock-clearing abilities.

- Lightweight and stays close to filling the "stock envelope"
- Fab Fours 90mm fog and 60mm turn indicator lights are included FREE with the bumper!
- Winch ready for 10,000 lb winches or smaller (Doesn't accept the WARN PowerPlant)
- 1" D-ring mounts

- Part No. JK07B18511** - 07-15 Wrangler JK
Part No. JK07B18501 - 07-15 Wrangler JK, With Grille Guard



Rear Bumper with Tire Carrier

- Recessed 3/4" D-Ring mounts
- Will handle up to a 40" tire
- Compatible with the factory receiver hitch
- CB antenna mount
- Locking pin next to swivel on tire carrier allows easy access to the rear compartment

07-15 Wrangler JK

- Part No. JK07Y12511** - Rear Base Bumper
Part No. JPY1251T1 - Tire Carrier



GO RHINO®

FIT. FUNCTION. STYLE.

NEW BR SERIES MODULAR WINCH BUMPERS FOR JEEP® JK WRANGLER COMING SOON

3 light bar options: standard, angular, and stinger style

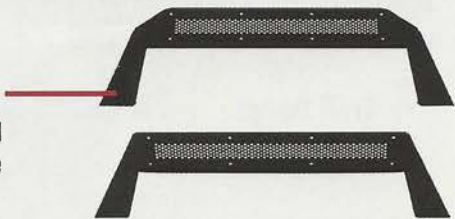

BODY PROTECTION

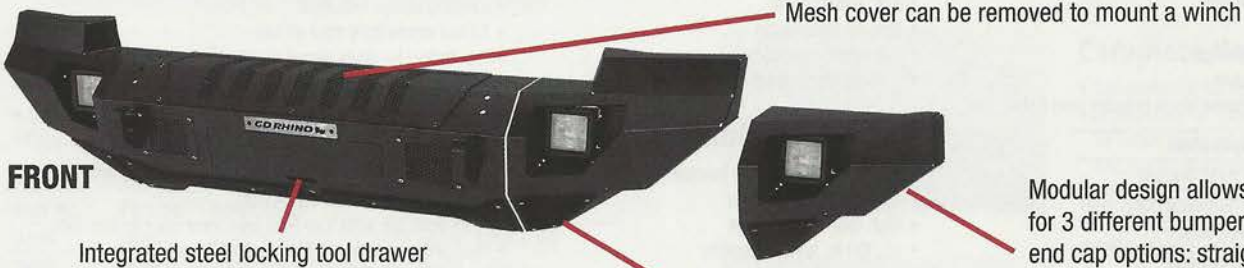

Modular design allows for 3 different bumper end cap options: straight, stubby, and full



Full wrap end cap option with step area

RB10 RUNNING BOARDS

RB10 RUNNING BOARDS provide extra body protection from flying debris while offering a wide, safe step for easy entry and exit. The boards are coated with OEM-approved bed liner material that provides a super grippy step surface and a tough, durable finish that's backed by a 5-year warranty. For taller, lifted Jeeps® with larger wheels and tires, add optional bolt-on RB10 Drop Steps that give an extra 4" drop for easier access to the vehicle.



Part No.	Application
63450568T	RB10 for Jeep® Wrangler Unlimited
63410000T	RB10 Drop Step

DOMINATOR HOOP STEPS

DOMINATOR HOOP STEPS for Jeep® JK are wheel-to-wheel steps built tough enough to take a beating. Constructed from high strength round steel tubing with strategically positioned drop steps under each door, these heavy-duty bars protect the rocker panel and also offer a safe step in all kinds of conditions whether on road or off.



Part No.	Application
D24505T	Dominator D2 Textured for Jeep® Wrangler Unlimited
D24505PS	Dominator D2 Polished for Jeep® Wrangler Unlimited



Part No. JK19531 - 07-16 Jeep® Wrangler JK

Rear Bumper and Swing Arm

- 5mm thick steel plate
- High clearance design
- Axle shaft pivot
- Double wheel bearings
- Dual recovery points
- Dual process textured black powder coat finish

Part No.	Application
JK2394	JK Rear Bumper
TJ2994	TJ Rear Bumper
5294	Swing Arm
5127	Can Carriers
5128	Jack Brackets

RockCrawler Sliders

- 2" x 3" rectangular tube
- 3/4" kick out trail
- Bolt-on installation
- Full length coverage
- Dual process powder coat

Front Winch Bumper

- 5mm thick steel plate bumper shell
- Integrated winch plate
- High clearance design
- 10,000 lb. winch capacity
- Bolt-on center grille guard
- Dual recover points
- Dual process textured black powder coat finish
- Does not require relocation of vacuum pump

Trail Doors

- 3/4" steel tube construction
- Exclusive internal latch
- Includes nylon webbing and arm pads
- Textured black powder coat finish
- Limiting straps included
- TJ has dome light shut off bar
- Pre-drilled for Body Armor mirrors

Cargo Racks

- Front arms attach to "A" pillar, rear mounts to frame rails (optional body mount on JK kits)
- Front light bar with four light tabs, rear bar has two tabs
- Dual process textured black powder coat finish
- Can hide wiring harness inside tubing
- Accepts Part No. 5124 aluminum cargo basket or Part No. 5125 rack adapters for Yakima accessories

Part No.	Description	Application
JK19531	Front winch bumper, high clearance design	07-16 JK Wrangler
JK2951	Tubular Rear Base Bumper	07-16 JK Wrangler
JK3103	Flat winch plate, Jeep® JK only	07-13 JK Wrangler
JK4123	RockCrawler Side Bars, JK 2 Door	07-16 JK Wrangler
JK5123	Front skid plate, JK Only	07-16 JK Wrangler
JK6125	JK 2 Door Cargo Rack Base unit. Two Box set	07-15 JK Wrangler
JK6135	Trail Doors for JK front, set of 2	07-16 JK Wrangler
JK7133	JK Taillight guard for JK flat design	07-16 JK Wrangler
JK6124	Jeep® JK Unlimited Cargo Rack, Base Unit. Two Box Set	07-15 JK Unlimited
JK6126	Front Light bar for Jeep® JK, (requires 5129 basket)	07-16 JK
JK6139	Trail Doors for JK Front (fits either 2 Door or Unlimited) Set of 2	07-16 JK ALL
JK140	Trail Doors for JK Unlimited Rear Set of 2	07-16 JK Unlimited
JK4121	RockCrawler Side Bars Jeep® JK Unlimited	07-16 JK Unlimited
JK4122	RockCrawler Side Bars Jeep® JK 2 Door	07-16 JK
JK4123	RockStep, JK Unlimited	07-16 JK Unlimited
JK19532	Mid-Stubby Style Front Winch Bumper	07 -16 JK Wrangler
JK2395	New Rear Bumper with Adjustable Pin, Accepts Swing Arm 5295	07 -16 JK Wrangler
JK6139	Gen III Trail Doors JK Front	07 -16 JK Wrangler
JK6138	Gen II Trail Doors JK Rear	07 -16 JK Wrangler
TJ1951	Tubular Front Bumper Pre-Runner Style Jeep® Wrangler YJ and TJ	87-96 YJ and 97-06 TJ
TJ19531	Bumper, High Clearance Design, with Grille Guard	97-06 YJ/TJ/TJL
TJ2951	Base Rear Bumper Tubular Style	97-06 TJ
TJ2994	Bumper, Formed Style, Accepts Tire Carrier	87-95 YJ and 97-06 TJ
TJ4121	Jeep® TJ - RockCrawler Side Guards	97-06 TJ
TJ6125	TJ Short Wheel Base Roof Rack Base Unit. Two Box Set	97-06 TJ

Part No.	Description	Application
TJ6125	TJ Short Wheel Base Cargo Rack Base Unit. Two Box Set	97-06 TJ
TJ4322	Tub Rails for TJ	97-06
TJ5322	Extreme Rock Rail Standard TJ New Item	97-06 TJ Standard Wheel Base
TJ4121	RockCrawler Side Guards Jeep® TJ	97-06 TJ
TJ4321	Tub Rails for TJL	04-06 TJ Unlimited
TJ5321	Extreme Rock Rail, TJL	04-06 TJ Unlimited
TJ5322	Extreme Rock Rail Standard TJ	97-06 TJ

Accessories

Part No.	Description	Application
5125	Roof Rack Adapters For Body Armor Roof Racks, Pair	Body Armor Base Racks
5127	Gas Can Adapter Kit, Standard Cans, For Swing Arm 5294	Body Armor Swing Arm 5294
5130	Roto-Pax Can Cradles Only (No Cans)	5127 Mounting Arms
5294	Swing Arm Tire Carrier	Body Armor JK2394 and TJ2994 Bumper
5126	Mirrors For Trail Doors Sold As Set	Body Armor Trail Doors 97-15 Wrangler
3200	Vertical Tow Bar Adaptor Brackets (Pr)	Body Armor Front Bumper
5127	Gas Can Adapter Kit, 2 Cans, For Swing Arm 5293 and 5294	Body Armor Swing Arm 5294
5128	Hi-Lift Jack Adapter Kit For Swing Arm 5294 (3 Pcs)	Body Armor Swing Arm 5294
5131	Roto-Pax Can System For 5294 Swing Arm (No Cans)	5294 Swing Arm
5295	Swing Arm For Rear Bumper JK-2395	Swing Arm For JK2395 Only
JK5120	Elevated LED CHSML 3rd Brake Light Kit	Wrangler YJ, TJ and JK



Jeep® Recovery Bumpers for YJ, TJ, JK

- Custom welded shackle mounts with clevis 1"
- Front JK recovery bumper accepts Jeep® factory
- Front Bumper includes a FREE winch plate (JK only)
- Custom D-ring shackles included on front and rear bumpers
- No drill install

Front Part No.	Application
07-16 Jeep® Wrangler JK, Bumper with stinger	
86510	Semi Gloss Black Finish
88510	Textured Black Finish
88509	Textured Shorty Bumper
76-06 Wrangler YJ, TJ, Bumper with stinger	
76510	Smooth
78510	Textured Black
Rear Part No.	Application
07-16 Wrangler JK, includes D-rings, (2 4" light receptacles – lights ordered separately)	
86605	Semi Gloss Black Finish
88605	Textured Black Finish
86606	Semi Gloss Black w/ Swing Away Tire Carrier
88606	JK Textured Bumper w/ Swing Away Tire Carrier
87-06 Wrangler YJ, TJ Rear, with swing-away tire Carrier (lights ordered separately)	
76610	Smooth
78615	Textured



Bumpers

- No relocation of OEM components
- OEM fog light mounting locations
- Easy install; no brackets needed

Part No.	Application
94100	07-15 Bumper Only - Winch Style
94201	07-15 Rear Bumper (with Tire Attachment)
94300	07-15 Bull Bar
94400	07-15 Tubular Steps (4 Door Models Only)
94500	07-15 Rear Bumper (No Tire Attachment)

Westin WESTIN™

NEW

Recoil Rear Bumper

- Made of 7 gauge steel
- One-piece fully welded construction
- 1" thick HD shackle mounts
- (2) Flush Mount LED lights included
- Laser-cut Snyder logo on ends
- Tire carrier attaches to tailgate



Part No.	Application
551522JKS5	07-16 JK Wrangler - Recoil Tire Carrier
550522JK5	07-16 JK Wrangler



M/T Metal Jeep® JK Bumpers

07-15 Wrangler JK

Front:

- 3 bumper end options: flush end, stubby, and full length
- 2 guard options: low & "stinger" style (end cap required)
- Stubby & full length bumper ends have integrated rock light ports
- Accepts most winches, including Warn® Zeon
- Low winch mounting maximizes radiator air flow
- Lightweight, modular construction can easily be re-configured for different looks
- Easy to install

Rear:

- Bumper has integrated rock light ports
- Optional tire carrier swings with tailgate for one-handed operation
- Tire carrier has positive lockout for opening on angled surfaces



Part No.	Application
Front	
020418	Front Bumper, JK, S1 Black
020481	Winch Plate, S1 Black
020484	Guard Stinger, S1 Black
020480	Guard Low, S1 Black
020482	Flush End, S1 Black
020419	Stubby End Cap, S1 Black
020483	Full Length End, S1 Black
020485	Vac Pump Bracket, S1 Black*
Back	
021476	Rear Bumper, JK, S1 Black
021477	Tire Carrier, S1 JK Black
021478	Rear Brake Light, S1 JK
021479	High Lift Jack Mount, S1 Black





PERFORMANCE SUSPENSION & SHOCKS

Front Off-Road Bumper

- 1/4" thick steel construction
- Compact design provides maximum ingress clearance
- Accommodates most standard-sized winches
- Black powder-coated wrinkle finish

Part No. RS6220B - 07-16 Wrangler JK

Tubular Off-Road Doors 07-16 Wrangler JK

- Added visibility for off-road
- Retains factory side mirror (passenger and driver side)
- 1-3/4" tube construction
- Mounts to OE door hinge
- OE-style latch that can be opened from inside or outside
- Durable textured black powder-coated finish

Part No. RS6216B - Front door

Part No. RS6217B - Rear door

RockGEAR™



MADE IN THE USA



Part No. RS6218 - DANA 30

Part No. RS6209 or RS6209B - DANA 44

Part No. RS6205

Note: adapter bracket is required when installing Rancho Dana 44 differential cover with Rancho RS6509 Long-Arm suspension system.

Door Sliders

- Added body protection for rocker panels
- Thick-walled 1-1/2" tube construction
- High-clearance design follows body contour
- Convenient step to allow for easier entry/exit
- No cutting or drilling installation
- Durable textured black powder-coated finish



Differential Cover

- Added axle and internal gear protection
- Manufactured from high-strength nodular iron
- Ribbed external construction for added strength
- Offset over-sized fill plug for increased fluid capacity and easier/quicker filling
- Durable red powder-coated finish



Rear Door Cover Plate

- Protects rear decompression vent
- CB antenna mount included
- Reuses factory bolts and hole locations
- Designed to cover vent when removing spare tire carrier

Part No. RS6237B

07-16 Wrangler JK 2/4 Door

Control Arm Skids

- Mount to front lower control arms (axle end)
- Reduce hang-ups and damage to the factory brackets
- Thick 3/16" steel construction
- Bolt-on in minutes
- Durable red or black powder-coated finish

Part No. RS6210 - 07-16 Wrangler JK, Red

Part No. RS6210B - 07-16 Wrangler JK, Black

Rear Bumper with Tire Carrier and Jack Mount

- Swing away design works with rear door to open and close together making access to the cargo area quick and easy
- Rancho Black textured powder-coat finish
- 1/4-in. High-strength low-alloy steel construction
- Designed to maximize ground clearance
- Maintains O.E. tow hook connection (tow hook not included)
- Rear vent cover and CB antenna mount included
- Hi-Lift jack mount with quick release straps and a padlock secure location

07-16 Wrangler JK

Part No. RS6214B - 2 Door Sliders

Part No. RS6215B - 4 Door Sliders



Differential Glide Plate

- Mounts to front axle casting
- Allows for a much smoother glide over obstacles forward and backwards
- Protects casting from direct contact
- Durable red or black powder-coated finish
- Works with OE and most aftermarket differential covers



Part No. RS6222 RS6222B - Front DANA 30

Part No. RS6212 RS6212B - Front DANA 44

Part No. RS6242 RS6242B - Rear DANA 44

Part No. RS6235B - 07-16 JK - opens with rear gate

Part No. RS6221B - 07-16 JK - opens separate of rear gate

Part No. RS6229B - 97-06 TJ - opens separate of rear gate

Part No. RS6238 - 07-16 JK 2/4 Door, 97-06 TJ/LJ, rear LED light

Oil Pan Protection

- 1/8" steel construction
- Easy installation, installs over OEM oil pan
- Shields the entire oil pan and maintains drain-hole access
- Durable red or black powder-coated finish
- Can only be used on 3.8L JK motor



Part No. RS6236 - 12-14 Wrangler JK

Part No. RS6208 - 07-16 Wrangler JK,

4.0L V6 models only

Extended Length Brake Lines

- Stainless steel braided front & rear Brake Lines are protected w/ a vinyl cover
- Provides a firmer and more responsive braking
- Mounting brackets included where necessary
- Sold in pairs



Part No. RS6247 - Front (24.5-INCH)

Part No. RS6248 - Rear (22-INCH)



OFF CAMBER FABRICATIONS
"MART"

Spare Tire Carrier

- Fits up to 37 x 13.5" tire
- Direct-fit black steel

Part No. 130718 - 07-15 JK Wrangler
Part No. 131042 - 97-06 TJ Wrangler

TERAFLEX



HD Hinged Tire Carrier

- Maintains single one-handed entry to the cargo area
- Allows adjustment for up to 37" tire

Part No. 4838150 - 07-15 Wrangler JK, Adjustable
Part No. 4838130 - 07-15 Wrangler JK, Direct Fit

TJ Bellyup Skid Plate Kit

Increases your ground clearance by up to 2-3/8" by replacing the factory skid plate with a lower-profile 1/4" plate steel heavy duty skid plate.

Part No. 4648403 - 97-06 TJ

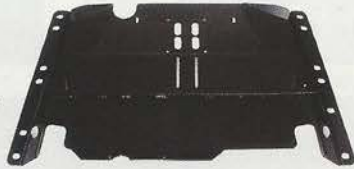

TJ HD Transmission Skid Plate Kit

Attaches easily to the BellyUp Skid Plate. It is laser cut from 3/16" steel and powder coated for durability. Must be used in conjunction with the BellyUp skid plate, and the TeraFlex HD oil pan skid plate.

Part No. 4607100 - 97-06 TJ

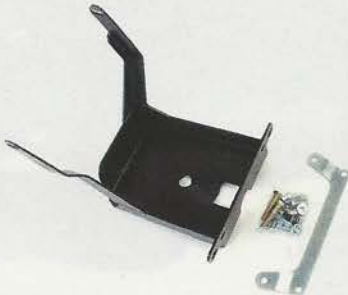

TJ HD Oil Pan Skid Plate

Fits 4.0L 6 cylinder engine only.

Part No. 4667100 - 97-06 TJ



Skid Plates

4X4 ACCESSORIES 12-15 Wrangler JK Unlimited 2-4 Door

- Designed to protect vital underbody components including steering, engine oil pan, transmission and transfercase
- Manufactured from folded 3mm laser cut steel
- Easily removed for vehicle servicing

Part No. 5450110 - Full Under Body
Part No. 5450100 - Engine And Transmission Pan



See pages 38, 48 and 50 for more Skid Plates.
Skid Plates also available from JKS, Rugged Ridge and OR-FAB.



Oversized Tire Carrier
07-15 Jeep® JK

- Utilize factory rear bumper
- Solid 1 piece construction
- Precision built for a perfect fit
- Textured matte black

Part No. J072743

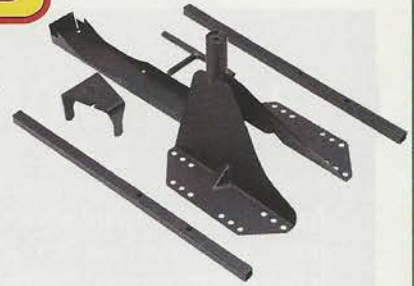

Part No. J0746
07-15 Wrangler JK (2-Door)

Part No. J0764
07-15 Wrangler JK (4-Door)

Part No. J1246
12-15 Wrangler JK (2 Door)

Wheel-to-Wheel Nerf Steps

- Main bar extends from tire to tire
- All bolt-on design that won't flex
- Solid 1-piece construction



Rock-Rails and Steps
07-15 Jeep® Wrangler JK

- Main bar extends from tire to tire
- Bar is positioned high and tight
- All bolt on design that won't flex
- Textured matte black
- Precision built for a perfect fit
- Solid 1 piece construction
- Utilize factory rear bumper



Part No. J0776643 - 07-15 Jeep® JK 2 Door Rocker
Part No. J0776644 - 07-15 Jeep® JK 4 Door Rocker
Part No. J072RKR - 07-15 Jeep® Wrangler JK 2 Door Step*
Part No. J074RKR - 07-15 Jeep® Wrangler JK 4 Door Unlimited Step*
*Steps sold separately as a pair (JPTS32)

R.S.P. Front Bumper with Aluminum Skid Plate



- Mounts two rigid custom made 38" LED E-series light bars
- R.S.P. full replacement front bumper with aluminum skid plate
- Standard color is textured matte black
- All bolt on design that won't flex
- .095 Wall tubing with gloss black powder coat finish
- Comes with our standard logo skid plate

Part No.	Application
J074LRSPW	07-15 Wrangler
J073RSPW	07-15 Wrangler
J074RSPW	07-15 Jeep® Wrangler JK Winch Ready, with Outer Bars
J074LRSP	07-15 Jeep® Wrangler JK - with Outer Bars
J072LRSPW	07-15 Jeep® Wrangler JK, with Skid Plate
J073RSPW	07-15 Jeep® Wrangler JK, No Outer Bars, Four 9" Lights
J973RSP	97-06 Wrangler TJ, No Outer Bars



TRAIL ARMOR® FOR JEEP®

Shield your Jeep® Wrangler with Bushwacker Trail Armor®! Our award winning body guards are made of exclusive Dura-Flex® 2000 TPO which is resistant to extreme climates. Bushwacker Trail Armor® protects your Jeep's most vulnerable areas so you can explore confidently.



0-7-16 Jeep® Wrangler JK



JK Rear Corners



JK Hood Scoop



JK Hood Protector



JK Rocker Panel and Sill Plate



TJ Rear Corners



TJ Front Corners



TJ Hood Protector



97-06 Jeep® Wrangler TJ

Bushwacker Trail Armor® for Jeep®

Part No.	Application
14001	97-06 Wrangler TJ (Compatible with Bushwacker Pocket Style Flares ONLY, Not compatible with Unlimited LJ Model) - Rear Corner Pair
14004	97-06 Wrangler TJ (Compatible with Factory Flares or Bushwacker Flat Style Flares ONLY, Not compatible with Unlimited LJ Model) - Rear Corner Pair
14005	97-06 Wrangler TJ - Hood Stone Guard and 2 Front Corners
14007	97-06 Wrangler TJ - Front Corners
14002	97-06 Wrangler TJ (ex. Unlimited LJ Model) - Side Rocker Panels
14008	97-06 Wrangler TJ (ex. Unlimited LJ Model) - Pocket Style Rocker Panels
14003	97-06 Wrangler TJ - Front & Rear Accent Pieces
14006	97-06 Wrangler TJ - Hood Stone Guard

Bushwacker Trail Armor® for Jeep®

Part No.	Application
14901	97-06 Wrangler TJ (Compatible with Bushwacker Pocket Style Flares ONLY, Not compatible with Unlimited LJ Model) - Six Piece Set
14902	97-06 Wrangler TJ (Compatible with Factory Flares or Bushwacker Flat Style Flares ONLY, Not compatible with Unlimited LJ Model) - Six Piece Set
15001	98-16 Wrangler - Hood Scoop (Smooth ABS)
15002	98-16 Wrangler - Hood Scoop (Textured TPO)
14009	07-16 Wrangler JK 2-door Sport Utility - Rear Corners
14010	07-16 Wrangler JK 4-door Sport Utility - Rear Corners
14011	07-16 Wrangler JK 2-door Sport Utility - Rocker Panel and Sill Plate Combo Pair
14012	07-16 Wrangler JK 4-door Sport Utility - Rocker Panel and Sill Plate Combo Pair
14013	07-16 Wrangler JK 2-door Sport Utility, 4-door Sport Utility - Hood and Tail Gate Protector Set



**Trailblazer
 Rocker Guards**

- 2" Tube dimension
- Off-road styling
- 3 year warranty

Part No. 424005 - 87-06 Wrangler TJ
 Part No. 424025 - 07-16 Wrangler JK 4 Door
 Part No. 424035 - 04-06 Wrangler JK 2 Door
 Part No. 424015 - 07-16 Wrangler JK 4 Door

Trailblazer Bumpers

- Shackle mount tabs
- Contoured bumper provides off-road protection
- Angled light bar with light mount ready brackets

Front Winch Bumper

Part No. 422005 - 87-06 Wrangler TJ
 Part No. 422015 - 07-16 Wrangler JK

Rear Bumpers

Part No. 423015 - 07-16 Wrangler JK

See In-Store For Complete Part Number Listing.



**Gen-X Oval Tube
 Black Powder Coat E-Coated Mild Steel**

- Mount kit included
- Molded and UV stable step pad
- Rocker panel mounting
- 3 Year Warranty
- 4" Oval upper bar serves as an accent bar
- Drop down nerf step is a 2" oval tube
- Patent# 6588783, 6874801

Stainless Part No.	Black Part No.	Application
203290	203295	07-16 Wrangler Unlimited - 4 Door
203310	203315	07-16 Wrangler - 2 Door



Oval Tube Steps

- Saddle mounted step pad
- Molded oval end-caps
- Cradle mounted tubes
- No-drill installation
- Mount kit required (sold separately)

Polished Part No.	Black Part No.	Mount Kit Part No.	Application
225000	225005	221725	07-15 Wrangler Unlimited - 2 Door
225050	225055	221725	07-15 Wrangler Unlimited - 4 Door



Platinum 4" Oval Step Bar

- 90° mandrel bends
- 4" wide step pad
- 4.25" wide at widest dimension
- Mount kit included
- E-Coated Mild Steel or 304 Stainless Steel

Polished Part No.	Black Part No.	Application
213310	213315	07-15 Wrangler - 2 Door
213290	213295	07-15 Wrangler - 4 Door



E-Series Step Bars

- Polished 304 stainless steel
- Black powder coat mild steel
- No-drill installation

Polished Part No.	Black Part No.	Application
233310	233315	07-16 Wrangler - 2 Door
233290	233295	07-16 Wrangler - 4 Door
232850	232855	04-06 Wrangler - Unlimited
230970	230975	97-06 Wrangler/SE/Sport/Sahara



Signature Series Step Bars

- 3" round tube
- Galvanized mild steel
- Recessed step area
- Mount kit included
- No-drill installation

Chrome Part No.	Black Part No.	Application
253310	253315	07-16 Wrangler - 2 Door
253290	253295	07-16 Wrangler - 4 Door
252850	252855	04-06 Wrangler - Unlimited
250970	250975	Wrangler/SE/Sport/Sahara

TRAILFX



3" Stainless Steel Side Bars

Includes ABS injection molded plastic step plates and powder coated vehicle-specific mounting brackets for ease of installation. Styles include Stainless Steel and Black Powder Coated Steel. Drilling not required.



Stainless Part No.	Black Part No.	Textured Part No.	Application
1160632071	1160632073	A0027T	07-16 Wrangler - 2 Door
1160631071	1160631073	A0028T	07-16 Wrangler - 4 Door
1160630971	1160630973	—	97-06 Wrangler



Slimline 2" Side Bar with Recessed Step

- Non-skid step pads
- Dual stage textured powder coat finish
- New low profile design with individual entry steps
- Vehicle specific design for custom fit and alignment
- No drill – easy installation using factory bolt locations

Part No. 26628 - 07-16 JK Wrangler Unlimited 4 Door

Part No. 26627 - 07-16 JK Wrangler 2 Door

Part No. 26625 - 97-06 Wrangler TJ



TranSender Steps

Extremely versatile, extremely durable, and extreme styling!

Available in four distinctive styles to enhance the appearance and value of your vehicle. ABS boards and end caps are UV protected and look great black or can be painted to match your vehicle for a true custom look.



Part No. 101096 - 07-16 Wrangler Unlimited 4 Door

Part No. 101144 - 07-16 Wrangler Unlimited 2 Door

Boards and brackets must be ordered separately.



Fits any of LUND'S Steps or Boards



EZ Bracket Mount For Running Boards

Eliminate vibration and road noise while ensuring a rock-solid professional installation of your running boards with these heavy duty bracket kits from Lund. Lund offers custom-fit moulding kits for each application while several no-drill applications are also available.



EZ Bracket Mount Part No.	TrailRunner Part No.	Application
300051	291121	06-10 Grand Cherokee
300063	291121	05-10 Commander

Side Steps



Integrated Design - Custom Styling

Part No. 885138
11-16 Grand Cherokee



Dominator II

The Go Rhino! Dominator II SideSteps run wheel to wheel and have a unique drop-down step with race-style aluminum step pads that allow for easy access in and out of your vehicle. The step pad comes in black powder-coat or silver aluminum finish, and you can easily remove them and have them custom painted or anodized to match your vehicle.

Part No. D24505T - 07-16 Wrangler JK, Black Powder Coat

Part No. D24505PS - 07-16 Wrangler JK, Stainless Steel



Dominator

- Includes anti-rattle device and a convenient black storage bag
- Comes with "Original" Dominator hoop step pad for extra room in the hoop
- Dual step for hard-to-reach storage areas or racks are now easily accessible
- Manufactured of the highest quality steel for unmatched strength and durability
- Polished stainless finish has a limited lifetime warranty
- Textured black powder coat with a 5 year warranty

Part No.	Application
D360PS	15-16 Wrangler - Polished Stainless
D360T	15-16 Wrangler - Textured Black



Sidearm Rock Rails

- Made of 7 gauge steel
- 2" diameter, .120" thick wall tube
- Mounts directly to vehicle frame
- Welded support plate with laser-cut Snyder logo
- Available for 2 and 4 door
- No drilling required

Part No.	Year	Application
426005	14-15	Wrangler Limited - 2 Door
426015	14-15	Wrangler Unlimited - 4 Door





NEW

ZEON Platinum™ Advanced Technology, Ultimate Performance Winch

• Double The Durability

The ultimate insurance policy on the trail or jobsite. ZEON Platinum tested TWICE as durable as the previous generation of winches

• 20% Faster

With a no-load line speed of up to 44 feet per minute, ZEON Platinum is the perfect tool for driver-assisted vehicle recovery

• High Performance Package

Features a new high-performance motor for efficient amp draw and fast line speed, a stronger gear train, and high-strength sleeve-in-drum brake design

• IP68 Waterproof Rating

Advanced seals are designed to keep water and dust out

New 12K Synthetic

Advanced Wireless Control

Sophisticated smart device controls operation of the winch, remote clutch, and up to two accessories. Plus it provides operator feedback on motor temp and battery condition

Electrical controls are highly reliable and weather resistant

Brake with steel sleeve-in-drum design is durable and holds the full rated load

Connect your lights, or other accessory to the control module

Remote Clutch
Manual clutch has been eliminated



Large diameter alloy winch drum is light and reduces rope wear

Convertible control pack can be attached to the winch or remotely mounted (Relocation kit required and sold separately)



ULTIMATE PERFORMANCE WINCH SERIES



ZEON Platinum 10, and 12 Winches Newest Ultimate Performance Winches, Equipped With Steel Rope

- ZEON Platinum 12 delivers 12,000 lbs. pulling power
- ZEON Platinum 10 delivers 10,000 lbs. pulling power
- Includes 80' of 3/8" aircraft-grade wire rope and a roller fairlead

Part No. 92810 - ZEON Platinum 10
Part No. 92820 - ZEON Platinum 12



NEW

ZEON Platinum 12-S and 10-S Ultimate Performance Winches With Synthetic Rope

Includes 100' of 3/8" WARN Spydura® synthetic rope, a ballistic nylon sliding chafe sleeve, heat-resistant rope coating, and a polished aluminum hawse fairlead.

Part No. 95960 - 12K - 80' Spydura® Pro Rope
Part No. 92815 - 10K 100' Spydura Rope

Control Pack Relocation Kit

Hardware and wiring required to mount control box remotely from winch.

Additional wiring (optional)

Part No. 93373 - Light Harness Kit (Short) Part No. 89970 - Short Kit
Part No. 93375 - Light Harness Kit (Long) Part No. 92193 - Long Kit

Advanced Wireless Control Window Mount

Mount the wireless remote to your windshield.
Part No. 94437



- Innovative symmetrical design
- Convertible control pack with contractor controls
- Satin-black powder-coated finish, with stainless steel hardware
- Large diameter, lightweight alloy drum
- IP68 waterproof rating

ZEON 12 Superior Performance and Reliability

Part No. 89120 - 80' of 3/8" wire rope

ZEON 10, ZEON 10-S 10,000 lbs. of Cutting-Edge Pulling Muscle

Part No. 89611 - ZEON 10-S (100' of Spydura® synthetic rope)
Part No. 88990 - ZEON 10 (80' of wire rope)

ZEON 8, ZEON 8-S Advanced, Capable, and Strong

Part No. 89305 - ZEON 8-S (100' of Spydura® synthetic rope)
Part No. 88980 - ZEON 8 (100' of wire rope)



WARN® PowerPlant 9.5 and 12

New and Improved Winch/Air Compressor Now Offers Increased Performance and Reliability

- To combine a powerful winch with a high-performance air compressor for the ultimate vehicle-mounted multi-tool.
- The PowerPlant 9.5 has a pulling capacity of 9,500 lbs.; the PowerPlant 12 will pull 12,000 lbs.
- PowerPlant is equipped with a powerful air compressor that can air up four 35" tires in eight minutes
- New features include stainless steel fasteners, a new pressure switch, a revised contactor, a new air hose, and a corrosion-resistant flat-black finish
- Intercooler/air reservoir reduces compressed air temperature
- Half-gallon air reservoir helps even airflow
- High-output air compressor delivers 5 CFM @ 90 PSI; maximum air pressure is 100 PSI

Part No. 91800 - PowerPlant 9.5

Part No. 91801 - PowerPlant 12

ULTIMATE PERFORMANCE WINCH SERIES

ULTIMATE PERFORMANCE WINCH SERIES



Endurance 12.0

12,000 Lbs. of Pulling Power. 0 Pounds of Quit.

- Remote-mount fan cools the winch motor for the ultimate in performance, delivering the longest duty cycle of any electric winch on the market today
- Heavy-duty contractor for increased durability and reliability
- High-speed, three-stage planetary gear train for fast, smooth, and dependable operation
- Stainless-steel clutch lever and hardware for protection against the elements
- Extreme-duty winch sealing to keep the elements out

Part No. 73010

ULTIMATE PERFORMANCE WINCH SERIES



9.5xp

Extreme Performance. Top of the line. Fast and powerful.

- Available in two versions: 100' of wire rope with roller fairlead, or WARN Spydura® synthetic rope with polished aluminum hawse fairlead
- High-output parallel series wound winch motor is the strongest and most durable in the industry
- Extreme-duty winch sealing. Enables superior water resistance
- Extended-duty control pack delivers long duty cycle to tackle the most demanding pulls. Remote-mount design allows for various mounting options
- Remote control with 12' lead
- High gloss, chip-resistant powder coat finish.
- Provides superior corrosion resistance

Part No. 68500 - 9.5xp, Wire Rope, Roller Fairlead

Part No. 87310 - 9.5xp-s, Synthetic Rope, Hawse Fairlead



Massive protective structure combined with sophisticated operator feedback.

9.5ti Thermometric

- Motor-mounted thermal sensor relays temperature information to winch operator by way of the remote control with LED indicator
- Series-wound motor and 3-stage planetary geartrain deliver 9,500 lbs. of pulling capacity
- High gloss, chip-resistant black powder coat finish over a massive cast-aluminum alloy housing
- Comes with steel or synthetic winch rope, hook, remote control on 12' lead, and roller or hawse fairlead

Part No. 97550 - 9.5cti, With Wire Rope and Roller Fairlead

Part No. 97600 - 9.5cti-s, With Synthetic Rope and Aluminum Hawse Fairlead

Part No. 85760 - 9.5cti Multi-Mount, Wire Rope

WARN Winch Damper

Extreme Performance

- Helps to prevent rope recoil in the event of a rope failure
- Rubber-coated center section guards against sliding
- Durable vinyl construction
- Pocket for accessory storage
- Reflective strip for increased visibility

Part No. 91575



Neoprene Winch Covers

Extreme Performance

- Elastic cover stretches over winch
- UV protectant spray included to prolong the life of the winch cover

Part No. 91414 - Fits M8000, XD9000, 9.5xp, VR8000/VR8000-S; VR10000/VR10000-S; VR12000; and Tabor winches

Part No. 91415 - Fits ZEON 8/ZEON 8-S; ZEON 10/ZEON 10-S, and ZEON 12 winches





Premium Series Classic Design. Proven Performance

Long time best selling winches • Competition-grade power, speed, and reliability
 Pulling capacities to 9,000 lbs. • WARN Limited Lifetime Warranty

PREMIUM WINCH SERIES



XD9000i
Fast and reliable in real trail conditions.

- A favorite 9,000-lb. capacity off-road winch
- No-load retrieval line speed is fast — 38 feet / minute
- Integrated Solenoid
- 4.6 HP series-wound motor delivers big torque and power
- Runs cool with low amp draw for long winching duty cycles
- Proven split 3-stage planetary gear train system
- Comes with 125 ft. of 5/16" wire rope, hook, remote control on 12' lead, clutch, roller fairlead, and battery cables

Part No. 27550 - XD9000i Winch
Part No. 37441 - XD9000i Multi-Mount Kit.
 Includes winch, portable carrier, and wiring for front of vehicle (not pictured)

PREMIUM WINCH SERIES



M8000
Compact puller for trucks, sport utilities, and Jeep® vehicles.

- An 8,000-lb. capacity winch that offers outstanding value
- Line speed is fast across the pulling range — 42 feet / minute no-load retrieval rate, 8 feet / minute full-load pull rate
- 4.8 HP series-wound motor delivers big torque and power
- Runs cool with lower amp draw for longer winching duty cycles
- Available in two versions: wire rope with roller fairlead, or WARN® Spydura™ synthetic rope with polished aluminum hawse fairlead
- Comes with hook, remote control on 12' lead, clutch, and battery cables

Part No. 26502 - Wire Rope, 12V
Part No. 87800 - Synthetic Rope, 12V

PREMIUM WINCH SERIES



XD9000
Long-time best seller.

- A durable 9,000 lb. capacity winch
- Compact body, separate control pack allows use in tight spaces
- No-load retrieval line speed is fast — 38 feet / minute
- 4.6 HP series-wound motor delivers big torque and power
- Roller fairlead reduces rope abrasion
- Proven split 3-stage planetary gear train system
- Comes with 100 ft. of 5/16" wire rope, hook, remote control on 12' lead, clutch, roller fairlead, and battery cables

Part No. 28500

ULTIMATE PERFORMANCE WINCH SERIES



9.0Rc
Lightweight, compact winch for rock crawlers.

- Lightweight, short-drum
- 9,000 lb. capacity winch
- Includes 50' of 3/8" diameter synthetic rope with 360° swivel hook, polished aluminum hawse fairlead and remote control
- 4.8 hp series-wound motor and extreme duty control pack provide reliable operation and fast line speeds
- Three-stage planetary geartrain for fast, smooth, and dependable operation
- Automatic mechanical cone brake gives positive operator control during winching
- Gloss red paint with primer under-coat gives superior corrosion resistance
- Extreme duty winch sealing provides superior water resistance

Part No. 71550

ENTRY LEVEL WINCH SERIES



VR8000, VR8000-S
Great For Lighter Trucks, Jeeps, And SUVs

- 94' of wire rope, or 100' of synthetic rope
- Remote control with 12' lead
- Available in two versions: wire rope with roller fairlead, or WARN Spydura® synthetic rope with polished aluminum hawse fairlead
- Legendary WARN reliability and performance; 8,000 lb. single-line pulling capacity
- Low-profile design will fit most vehicles
- Separate control pack for various mounting options
- Mechanical brake for superior winching control
- Durable, smooth, and reliable three-stage planetary geartrain
- Series-wound motor for plenty of power and fast line speed

Part No: 86245 - VR8000 with wire rope and roller fairlead
Part No: 87835 - VR8000-S with synthetic rope and aluminum hawse fairlead

PREMIUM WINCH SERIES



M8274-50
Fastest Line Speed, Longest Rope

- The classic 8,000 lbs. capacity off-road winch
- No-load retrieval line speed is faster than ever—73.4 feet / minute
- Line capacity is long—150 ft. of 5/16" wire rope
- 4.6 HP series-wound motor delivers big torque and power
- Spur-gear drive train and upright design are totally rugged
- Comes with hook, remote control on 12' lead, free-spool clutch, roller fairlead, and battery cables

Part No. 38631

TRAILFX

NEW

Winch Specs

	NEW Part No. WS10B	Part No. W08B	Part No. W10B	Part No. W12B
Winch Capacity	10,000 lbs	8,000 lbs.	10,000 lbs.	12,000 lbs.
Rated Line Pull	10,000 Lbs., (4532 kgs.) single-line	8,000 Lbs., (3600 kgs.) single-line	10,000 Lbs., (4532 kgs.) single-line	12,000 Lbs., (5440 kgs.) single-line
Motor	6.5HP/12 V series wound	6.7 HP/12 V series wound	6.5HP/12 V series wound	6.5 HP/12 V, series wound
Remote Control	Wired/ Wireless Remote Switch with LED light, 12' (3.7m) lead	Remote Switch, 12' (3.7m) lead	Remote Switch, 12' (3.7m) lead	Remote Switch, 12' (3.7m) lead
Electrical Control	450 A Heavy Duty Solenoid	450 A Heavy Duty Solenoid	450 A Heavy Duty Solenoid	450 A Heavy Duty Solenoid
Solenoid Compliance	IP68	IP67	IP67	IP67
Gear Train	3 Stage Planetary	3 Stage Planetary	3 Stage Planetary	3 Stage Planetary
Gear Ratio	218 : 1	150 : 1	218 : 1	265 : 1
Clutch Type	Rotating Ring Gear	Rotating Ring Gear	Rotating Ring Gear	Rotating Ring Gear
Braking Action	Automatic Out Of Drum	Automatic In-The-Drum	Automatic In-The-Drum	Automatic In-The-Drum
Drum Size	2.5" Diameter / 8.82" Length	2.5" Diameter / 8.82" Length	2.5" Diameter / 8.82" Length	3" Diameter / 8.82" Length
Cable	9.5 mm Dia / 94' Length, Grey, Dyneema SK75, with metal loop	8.1 mm Diameter / 94' Length	9.1 mm Diameter / 94' Length	9.5 mm Diameter / 94' Length
Fairlead	Aluminum Fairlead	4 Way Roller	4 Way Roller	4 Way Roller
Recommended Battery	650 CCA minimum for Winching	650 CCA minimum for Winching	650 CCA minimum f or Winching	650 CCA minimum for Winching
Battery Lead	25 mm ² , 72" (1.8 m)	25 mm ² , 72" (1.8 m)	25 mm ² , 72" (1.8 m)	25 mm ² , 72" (1.8 m)
Weight	36 Kgs (79 lbs)	40 Kgs (88 lbs)	42 Kgs (93 lbs)	44 Kgs (97 lbs)
Mounting Pattern	10" x 4.5"	10" x 4.5"	10" x 4.5"	10" x 4.5"

Winch Accessories

Wireless Winch Remote Control

- Wireless remote operation for your TrailFX winch
- Freedom to operate within 30 ft.
- Shock resistant transmitter with easy "in and out" push button control
- Batteries included (CR2032 or equivalent)

Part No. WA019 - Remote

Part No. WA001 - Control Box



Work Gloves

- Essential for hand protection when winching
- Features reinforced palms for extra protection
- Handy velcro wrist straps keep gloves secure
- Made of heavy duty Dacron polyester

Part No. WA015 - Extra Large



Neoprene Winch Covers

- Water and severe weather resistant
- Soft and durable
- Fits all standard TrailFX winches

Part No. WA016



Mounting Plates

New and affordable TrailFX winch mounting plates and cradles are compatible with most standard light truck winches for the front or rear of most trucks and Jeeps®.

Part No. WA017 - Flat Fixed Mount

Part No. WA018 - Receiver Mount



Winch Rigging Kit

- Satisfies the needs of the off-road enthusiast with one easy and affordable accessory kit
- Offers high quality straps, gloves, D-rings, a snatch block and even a choker chain in one attractive TrailFX® heavyweight bag

Part No. WA014



Project ES Waterproof Winches

- SEC18(es) 18,000 Lbs.
Part No. 7750280W
- SEC15(es) 15,000 Lbs.
Part No. 765026W
- SEC12(es) 12,000 Lbs.
Part No. 7650251BW
- SEC9.5(es) 9,500 Lbs.
Part No. 7650246BW
- SEC8(es) 8,000 Lbs.
Part No. 7750141W
- SEC4500(es) 4,500 Lbs.
Part No. 7650115B

All Feature:

- Waterproof and dustproof to IP68 standard
- High output motors
- Fast line speeds
- Rugged planetary gear sets
- Automatic load holding brake
- Clockable gear side
- Synthetic rope or aircraft cable
- Fully sealed winches
- Submersible, 500 amp solenoids
- Marine grade remote control connectors
- Corrosion-free construction
- Stainless steel hardware
- Dacromet® coated roller fairleads



SEC15(es) Electric Winch

The lightest 15,000 pound winch in the industry! Weighing in at only 101 pounds, the SEC15 packs heavy duty power in its compact design. Featuring compact dimensions and 25% less weight than other winches in its class, the SEC15 mounts easily and is a great choice for full size trucks that are looking for big winch power without adding big winch weight to the vehicle's front end.



SEC4500(es) Electric Winch

- Our strongest winch to date
- Most lightweight for it's pulling capacity
- Fast line speeds
- Rugged planetary gear sets



SEC18(es) Electric Winch

- Our strongest winch to date
- Most lightweight for it's pulling capacity
- Fast line speeds
- Rugged planetary gear sets

SEC8(es) Electric Winch

- 100' of synthetic rope with ballistic sheathing on drum and outer layer
- 100' of galvanized cable
- Best in class performance

Recovery Gear



Off-Road Recovery Kit

- Innovative design
- Self contained kit
- Premium components

Heavy-Duty Recovery Kit

- Premium components
- Weatherproof construction
- Removable work tray



Plug and Play Wireless Remote

The industry's first truly wireless remote! Add a little convenience to your vehicle recovery: No more cutting and splicing, Mile Marker's new "Plug and Play" Wireless Remote Control is an effortless way to operate your winch. Simply plug the receiver in to your control box, and you are ready for wireless operation up to 50' away. The system includes a weatherproof, shock-resistant transmitter with dual-color operator feedback, and magnet-mounted receiver to get you up and running quickly.



Part No. 7076 - can adapt to any electric winch, regardless of manufacturer.

- No cutting or splicing wires
- Operable up to 50' away
- Plugs directly in to control box
- Adaptable to our hydraulic winches
- Weatherproof, shock-resistant transmitter with LED feedback
- Adaptable to any electric winch, regardless of manufacturer

ATV/UTV Recovery Kit

- Versatile case design
- Weatherproof construction
- Premium components

ATV/UTV Recovery Kit

- Part No. 19330** - 30' 30,000 Pound Rating
- Part No. 19315** - 15' 30,000 Pound Rating
- Part No. 19108** - 8' 7,200 Pound Rating

SUPERWINCH

Smartphone Winch Control

Superwinch ROAM - Combines sensors and Wi-Fi allowing your smartphone to control winch plus receive critical winch data.

Includes free app for iPhone and Android

- Part No. 2910** - ROAM for Talon
- Part No. 2912** - ROAM for Superwinch Terra
- Part No. 2914** - ROAM for Superwinch S-Series (all)
- Part No. 2916** - ROAM for Superwinch Tiger Shark and LP

- Power in, power out
- Wireless remote function
- Wi-Fi connectivity
- Reports motor temp, amp draw and more
- Use with your smartphone
- Warns of danger



- Save data to history
- Ability to post to facebook/twitter

NEW

High Performance Recovery Winches

TALON Series (with Solenoid Offset Mount)

- Part No. 1695200**
Talon 9.5 (9,500 lbs. Capacity)
- Part No. 1612200**
Talon 12.5 (12,500 lbs. Capacity)
- Part No. 1614200**
Talon 14.0 (14,000 lbs. Capacity)
- Part No. 1618200**
Talon 18.0 (18,000 lbs. Capacity)



- 15' Sealed ergonomic handheld remote, with led light
- Sealed motor and gear box
- Limited lifetime warranty, with 3-year electrical

High Performance Recovery Winches

TALON i Series (with Solenoid Center Mount)

- Part No. 1695210** - Talon 9.5i (9,500 lbs. Capacity)
- Part No. 1612210** - Talon 12.5i (12,500 lbs. Capacity)

- Power in, power out
- Heavy duty stainless steel roller fairlead
- Vs4 sealed and vented, submersible solenoid, centered mount
- 15' Sealed ergonomic handheld remote, with LED light
- Sealed motor and gear box
- Limited lifetime warranty, with 3-year electrical



The World's Greatest Winch Value!
Engineered and Tested in the USA.



Mid-Level Recovery Winches

Tiger Shark Series 9.5 and 11.5 Winches

- Part No. 1595200**
Tiger Shark 9.5 (9,500 lbs. Capacity)
- Part No. 1515200**
Tiger Shark 11.5 (11,500 lbs. Capacity)
- Power in, power out
- Limited 2-year warranty
- Sealed solenoid and motor
- 15' Sealed rubber handheld remote
- Automatic load holding brake



- Stainless steel tie bars and hardware
- Heavy duty stainless steel roller fairlead

Mid-Level Recovery Winches

Tiger Shark Series 13.5, 15.5 and 17.5 Winches

- Part No. 1513200**
Tiger Shark 13.5 (13,500 lbs. Capacity)
- Part No. 1515200**
Tiger Shark 15.5 (15,500 lbs. Capacity)
- Part No. 1517200**
Tiger Shark 17.5 (17,500 lbs. Capacity)



- Power in, power out
- Heavy duty stainless steel roller fairlead
- Weather sealed solenoid and motor
- 15' Sealed rubber handheld remote
- Automatic load holding brake
- Stainless steel tie bars and hardware
- Limited 2-year warranty

Entry Level Recovery Winch

LP SERIES Winches

- LP8500 (8,500 lbs. Capacity)
- Part No. 1510200**
LP10000 (10,000 lbs. Capacity)
- Part No. 1510200**



- Power in, power out
- Powder coated hawse fairlead
- Automatic load holding
- Mechanical brake
- Weather sealed solenoid and motor
- Galvanized wire rope
- Heavy duty removable, clevis pin and latch hook
- 12' Handheld remote
- Limited 2-year warranty



4-Way Roller Fairlead, Steel Rope And Hammer-Forged Hook | Comp Series Aluminum Fairlead And Synthetic Rope | Oversized Aluminum Crossbar | Remote Plug Cover | Wire Isolator



4-Way Roller Fairlead, Steel Rope And Hammer-Forged Hook | Comp Series Aluminum Fairlead And Synthetic Rope | Heavy Duty Wired Magnetic Remote Control | Magnetic Remote Attaches To Winch, Vehicle Or Accessories | Larger Clutch Lever For Ease Of Use With Gloves

Part No.	Description
97510	10,000 lbs. Winch System
98510	10,000 lbs. Comp Series with Synthetic Rope and Aluminum Fairlead Winch
97512	12,000 lbs. Winch System
98512	12,000 lbs. Comp Series with Synthetic Rope and Aluminum Fairlead Winch

Part No.	Description
97495	9,500 lbs. Winch System
98495	9,500 lbs. Comp Series with Synthetic Rope and Aluminum Fairlead Winch
97412	12,000 lbs. Winch System
98412	12,000 lbs. Comp Series with Synthetic Rope and Aluminum Fairlead Winch

- Mounts directly to vehicle frame
- Accommodates most major brand winches with a line pull rating of up to 16,500 lbs.
- Pre-drilled for quick mounting of Hawse or Roller Fairlead
- Made of 1/4 plate steel

- Optional MAX Bull Bar/Light Bar
- Optional Faceplate
- Optional Tow Hooks (463005 – 2 needed)
- Black powder coated and e-coated mild steel
- No-drill installation

**For All Westin Winches
Warranty**

Mechanical Components: 3 Years
Electrical Parts: 12 Months

ATV Series

Part No.	Model	Specifications
471220	ATV-2000	2000 lbs. 12V Winch, Steel Rope 0.85HP
471230	ATV-3000	3000 lbs. 12V Winch, Steel Rope 1.1HP



ATW Pro Trailer Series

Part No.	Model	Specifications
471245	ATW Pro-4500	4500 lbs. 1.3HP Winch, Steel Rope, Corded Hand-Held Control

Outback Series

Part No.	Model	Specifications
471795	EWI-9500	9500 lbs. 6.6HP 12V Winch, Steel Rope, Wireless Remote Control
471612	EWI-12000	12,000 lbs. 6.6HP 12V Winch, Steel Rope, Wireless Remote Control



Off-Road Series

Part No.	Model	Specifications
471486	EW-8500	8500 lbs. 5.5HP 12V Off-Road Series Winch, Steel Rope, Corded Hand-Held Control
471487	EW-8500S	8500 lbs. 5.5HP 12V Off-Road Series Winch, Synthetic Rope, Corded Hand-Held Control
471411	EW-11000	11,000 lbs. 5.5HP 12V Off-Road Series Winch, Steel Rope, Corded Hand-Held Control
471413	EW-11000S	11,000 lbs. 5.5HP 12V Off-Road Series Winch, Synthetic Rope, Corded Hand-Held Control

Ropes and Straps

Part No.	Description
473600	Synthetic Rope, 3/8" X 94' (9.4mm X 28M), 9500 lbs.
473610	94' Steel Rope (8.2mm, for Winches Rated Up To 9500 lbs.)
473620	94' Steel Rope (9.2mm, for Winches Rated Over 10,000 lbs.)
473202	4" Snatch Block

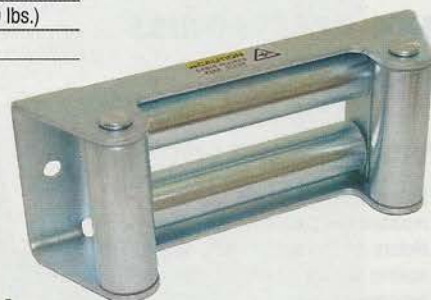

Hooks

Part No.	Description
473208	3/8" Clevis Hook
463005	Tow Hook

Fairleads

Part No.	Description
473400	4-Way Roller Fairlead, 8500 lbs. and Up
473420	ATV 4-Way Roller Fairlead

VIAIR®

Your Vital Air Source

Heavyweight Series Portable Compressors



Part No. 40045 - 400P-Automatic Portable Compressor Kit

(12V, CE, 33% Duty, 40 Min. @ 30 PSI)

Part No. 40047 - 400P-RV Automatic Portable Compressor Kit

(12V, CE, 33% Duty, 40 Min. @ 30 PSI)

Part No. 45043 - 450P-Automatic Portable Compressor Kit

(12V, CE, 100% Duty, 150 PSI)



Part No. 00025



Part No. 00030



Part No. 00037

Hoses

Part No. 00025 - 5-in-1 Deflator/Inflator, 25' Coil Hose, 100 PSI Inline Gauge, Bag

Part No. 00029 - 5-in-1 Deflator/Inflator, 25' Inside Braided Coil Hose,

120 PSI Inline Gauge, Bag

Part No. 00030 - 30' Extension Coil Hose (Closed-ended 1/4" Quick Coupler and Stud)

Part No. 00037 - 35' Coil Hose, with 1/4" M Swivel, with Close Ended Clip-On Chuck

Power Sport Series Portable Compressors



- 88P, 12-volt, CE
- Duty Cycle: 45% @ 100 PSI
- Max. Working Pressure: 120 PSI
- For Up to 33" Tires

Part No. 00088



- 90P, 12-volt, CE
- Duty Cycle: 15% @ 100 PSI
- Max. Working Pressure: 120 PSI
- 30 Min. @ 30 PSI

Part No. 00093



- 300P, 12-volt, CE
- Duty Cycle: 33% @ 100 PSI
- Max. Working Pressure: 150 PSI
- 30 Min. @ 30 PSI

Part No. 30033



- 400P, 12-volt, CE
- Duty Cycle: 33% @ 150 PSI
- Max. Working Pressure: 150 PSI
- 40 Min. @ 30 PSI

Part No. 40043



Part No. 00041



Part No. 00042



Part No. 90052

Air Accessories

Part No. 00041 - Tire Inflation Gun (Normally Closed Chuck, 200 PSI Inline Gauge)

Part No. 00042 - Digital Tire Inflation Gun, 2.5" Gauge, Reads Up to 200 PSI, with Carry Bag

Part No. 00043 - Inflation Kit with 2.5" Mechanical Gauge Tire Gun, 150 PSI, 30' Hose, Carry Bag

Part No. 90052 - Digital Tire Pressure Gauge (0-100 PSI, measures in PSI/BAR, blue backlit display)

Repair Kits and Tools

Carrying the appropriate tire accessories is essential when you're traveling off road. Not only do tires require regular PSI adjustment to suit differing terrain, it's not unusual to get several punctures in one day.



Part No.	Application
1000010	Speedy Seal Tire Repair Kit
ARB505	E-Z Deflator Kit
ARB605	Tire Inflator With Gauge
ARB506	Tire Pressure Gauge; 0-75 PSI; Analog Display; With Flexible Hose/ Dual Chuck
ARB508	Tire Pressure Gauge; 3-1/2 Inch Diameter Gauge; 0-50 PSI With KPA/ BAR; Analog Display; With Flexible Hose/ Dual Chuck



ARB

4X4 ACCESSORIES

X-Jack Exhaust Operated Jack

- Suited to use in sand, mud and snow
- Lifting capacity of 4,400 lbs.
- Provides up to 31" of vehicle lift

Part No. 72X10

Portable Air Compressor

- Built with sealed components for moisture and dust resistance
- Motors are thermal cut-out protected against damage caused by extreme temperature use

Part No. CKMP12 - 100PSI Max Pressure; 2.65 CFM; Battery Clamps; Without Air Tank; 12 Volt; Pressure Switch/ 19 Foot Air Hose

Part No. CKMTP12 - Twin High Performance; 150 PSI Max Pressure; 6.16 CFM; Battery Clamps





Medium-Duty Winch Accessory Kit

For Winches Up To 10,000 lbs. Everything You Need In One Kit

- Includes snatch block, tree protector strap, 2 D-shackles, and 2" x 30' recovery strap
- Heavyweight denier carry bag
- New WARN winching gloves

Part No. 88900

Winching Gloves

All new WARN winch gloves provide superior fit and protection. These gloves are designed to protect your hands from the sharp barbs and abrasion that may occur when handling winch rope.

- Durable synthetic leather with Kevlar reinforcement resists abrasion
- Extra reinforcements provide superior knuckle and fingertip protection
- Shock Absorbing Palm
- Terry cloth sweat wipe
- Neoprene wrist and pull strap
- ID Tag

Part No. 91650 - Large

Part No. 88995 - XL

Part No. 91600 - XXL



Premium Winch Accessories

Snatch Block

It also helps to reduce heat buildup and amp draw during recovery. Coated with Cerakote and able to accept both wire and synthetic rope.

Part No. 92188 - Rated to 12,000 lbs



Winch Hook

Cerakote coating provides maximum protection and reliability against wear and abrasion. Uniquely designed with built-in beverage opener.

Part No. 92091 - For 18,000 lbs.

Part No. 92090 - For 12,000 lbs.



Shackle

This forged steel clevis shackle provides a means for connecting the looped ends of cables, straps, and snatch blocks.

Part No. 92093 - Premium Shackle

3/4" - For 18,000 lb



Receiver Shackle Bracket

- Combines a heavy-duty receiver bracket with a 3/4" shackle
- Uses standard Class III receiver hitch as a recovery point

Part No. 29312



Wireless Winch Control

- Control your winch from up to 50' away
- Sealed for protection against the elements
- Easy plug-and-play installation
- Activation sequence guards against accidental power-ups
- Kit includes wireless transmitter, receiver, holster, lanyard and mounting hardware

Part No. 90287 - For Truck and Utility Winches.

Works with all five-wire truck winches and WARN 3700 DC, 4000 DC, and 4700 DC utility winches



WARN Spydura® Synthetic Rope

- Constructed of a unique ultra high molecular weight polyethylene material
- Delivers high abrasion resistance and excellent tensile strength
- Coated with urethane for increased UV and chemical resistance
- Includes a high temperature resistant sleeve on the first layer, and a unique self-tightening rope attachment designed to hold the rope secure on the winch drum
- A ballistic nylon sliding sleeve provides extra protection against abrasion and wear
- For winches with 10,000 lbs. pull rating or less

Part No. 87915 - 100' of 3/8" diameter synthetic rope

Part No. 88468 - 80' of 3/8" diameter synthetic rope



NEW

Spydura® Pro Synthetic Rope

Heat Treated Construction for Improved Strength

Spydura Pro synthetic winch rope using Spectra® 1000 is heat treated offering the maximum in tensile strength and load bearing capacity. The compacted diameter prevents sand and dirt from penetrating the fibers and extends the life of the rope. Coated with high temperature urethane, equipped with a temperature resistant sleeve on the first layer and a ballistic nylon sliding sleeve, Spydura Pro synthetic winch rope provides extreme protection against heat, wear and abrasion.

For 12K or Smaller Winches

Part No.	Description
93120	80'x3/8"
96040	100'x3/8"

For 18K or Smaller Winches

91820	100'x7/16"
-------	------------

Tree Trunk Protector

Rigging strap is used to secure winch rope to anchor point.



Part No. 88997 - 2" x 8' Rated to 14,400 lbs. breaking strength

Part No. 88995 - 4" x 8' Rated to 30,000 lbs. breaking strength.

Premium Recovery Strap

Best in the Industry

- Use a recovery strap to "snatch" or pull out a stuck vehicle
- Nylon webbing absorbs the shock of heavy pulls, while the elastic rebound energy aids in quick recovery

Part No. 88922 - 2" x 30' strap

Part No. 88922 - 3" x 30' strap



Roller Fairlead Cover

Part No. 60390 - For Standard Mounting Kit



Synthetic Rope Extensions

NEW

Spydura® Rope Extension

Part No.	Description
93118	25'x3/8"
93119	50'x3/8"

Spydura® Pro Rope Extension

93121	25'x3/8"
93122	50'x3/8"





ProLink XXL

Replace conventional winch hooks with the new safer, stronger, and smarter Factor 55 ProLink and ProLink XXL shackle mounts.

Made in the USA from 6000 series billet aluminum and is equipped with a 6Al-4V titanium double shear pin. In this case the shear pin diameter is .750" The base of the XXL is protected by the barbed high durometer EPDM rubber guard. With a working load limit of 24,000 lbs. and an ultimate failure of over 63,000 lbs.



Flatlink Industry's First Folding Shackle Mount

Eliminate the conventional winch hook and replace it with a safer and stronger FlatLink shackle thimble and D-ring.

- Compatible with all roller fairlead license plate mounting brackets
- When folded flat – less than 1.75" of thickness
- Weight – 23 ounces
- Max load rating : 16,000 lbs.
- Ultimate failure : greater than 40,000 lbs.
- Fits steel cables and synthetic winch ropes to 3/8" diameters



Part No. 000150_ - ProLink
Part No. 002100_ - ProLink XXL
Part No. 000500_ - FlatLink

Add to end of Part No. 1-Red, 2-Blue, 4-Black, 5-Silver, 6-Gray

ProLink

- Screw pin shackles are up to 5X stronger than conventional winch hooks
- Conventional hooks are too small to safely fit both ends of a recovery strap
- Billet construction — precision machined from 6061-T6 Kaiser
- 16,000 pound max load rating



The Best Vehicle Recovery Rope Ever!

Bubba Rope® is the original tougher, safer, kinetic energy recovery rope, developed from our military contracts for pulling off-road vehicles out of mud, sand or snow. It is the only snatch rope with a heavy vinyl polymer coating, Gator-ized® eyes, and a FREE mesh carrying case.

Recovery Ropes

Colors shown are standard. Custom colors available by special order.

Part No.	Application
176660BLG	Bubba - 7/8"x20' Blue
176680RDG	Bubba - 7/8"x30' Red
176700ORG	Big Bubba - 1-1/4"x30' Orange
176655BKG	Renegade - 3/4"x20' Camo Green



Gator-Jaw™ Soft Shackles



Named "Best New 4x4 Product At SEMA"

- **Stronger Than Steel** - 32,000 lbs. breaking strength
- **It Floats** - no more losing shackles in the water or muck
- **Flexible** - easily wraps around the most difficult pulling points
- **One Piece Construction** - no pins to fasten

Part No. 176745

The Tree Hugger™

Designed to protect your winch line from girdling the bark off nature's tree trunks (Ouch!) or fraying your synthetic winch line during off-road vehicle recovery. Made from 3 inch wide 100% polyester neon orange webbing. The Tree Hugger™ has a minimum breaking strength of 58,000 lbs.

Part No. 176006OR - 6'
Part No. 176000OR - 10'
Part No. 176016OR - 16'



Synthetic Replacement Winch Line

The most advanced winch replacement line for steel and other synthetic winch ropes. We started with a rigid non-metal eye. Strong as steel but safer and lighter than a heavy steel thimble. We coated the entire rope in heavy Gator-ized® vinyl armor resulting in no line "fuzzing" and better protection against abrasion, sand and ultraviolet light.

- Color banded every 10' to gauge amount of rope out
- Includes a Gator-Jaw® and removable Life Guard™ for added rope protection
- Repairable

Part No. 176756X80



Life Guard Your Bubba Rope®

Made from tough Kevlar® material, the Life Guard protects your Bubba Rope® from coming in direct contact with hard or abrasive surfaces during your recovery process.

Part No. 175993 - Bubba 2' x 8"
Part No. 175994 - Big Bubba 2' x 9"

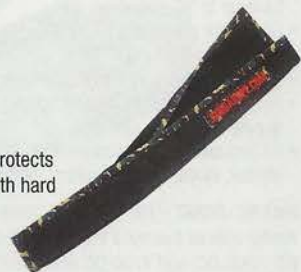

Recovery Straps

Part No.	Recovery Straps
CC220	20,000 lbs. 2"x20'
CC230	20,000 lbs. 2"x30'
CC330	30,000 lbs. 3"x30'
CC420	40,000 lbs. 4"x20'
Part No.	Tree Straps
CC408	40,000 lbs. 4"xX8'



Winch Accessory Bag

The all new Winch Accessory Bag from Smittybilt has all the needed trail tools to get the job done faster and easier.

Part No. 2726 - Winch Accessory Bag

54" Trail Jack



- Synthetic rubber handle holder
- Steel handle
- Removable handle
- 14 Gauge tubing (1-5/16" W) x (30" L)
- 28 sq. in base plate

Part No. 2722 - 54" Trail Jack

Receiver Hitch D-Ring

Part No.	Description
29312	Receiver D-Ring (Zinc)
29312B	Receiver D-Ring (Blk)
29313	Receiver D-Ring Fits 2.5" Receiver



R.U.T. Recovery Utility Tool

- Compact foldable military style shovel
- Soft side storage bag included
- Polycarbonate handle and neck
- Serrated edge to handle the roughest conditions
- Double position neck allows picking or shoveling

Part No. 2728 - Recovery Utility Tool



Tire Repair Kit

- Storage binder included
- Self-vulcanizing plugs
- Needle nose pliers
- Ergo strong aluminum handles for a lifetime of service
- Tire pressure gauge
- Extra valve stems

Part No. 2733 - Tire Repair Kit



Torx - Multi Tool

- 3/8" ratchet included
- 9 Chrome Vanadium bits included
- T15 to T55
- T50 (Tamper Proof) included
- Ballistic Nylon carrying case included
- Steel rail included

Part No. 2830 - 9-Piece Set



Universal Tire Deflators

Part No. 2723 - 4 Pack Tire Deflator

Jeep® Winch Cradle

Part No. 2811 - Winch Cradle



A.E.R. All Element Ramp

- Stackable design
- Can support up to 7,700 lbs.
- Manufactured of nylon reinforced plastic
- Sold in pairs, includes nylon storage bag
- Perfect for mud, snow, sand or loose terrain



Part No. 2790 - A.E.R. Ramp



Restraint Systems

- Simply connects at the top corners to existing seatbelt shoulder straps while the base of the restraint attaches to various floor mount options
- Design is intended to secure cargo within the back seating area enabling the utilization of the rear of the vehicle for storage purposes
- Fits in all vehicles makes and models. Are simple to attach and easy to use



Part No. QABSBN - 73" W x 79" L
 Part No. QABLBN - 73" W x 99" L
 Part No. QSSSBN - Short Box Net
 Part No. QSSLBN - Long Box Net



4X4 ACCESSORIES



Vehicle Recovery Kit

Kit includes large recovery bag, snatch strap, tree trunk protector, winch extension strap, recovery damper and leather recovery gloves.

Part No. RK9

Recovery Straps

- Specifically designed to stretch under load for maximum performance
- Very effective method of extracting a bogged or immobilized 4WD when a second vehicle is present

Part No.	Application
ARB705	2-3/8" x 30'; 17,500 lbs. Capacity
ARB710	3-1/8" x 30'; 24,000 lbs. Capacity
ARB715	4-1/8" x 30'; 33,000 lbs. Capacity
ARB720	2-1/8" x 60'; 9,900 lbs. Capacity





Part No. KU70039BK
Roller Fairlead Winch Isolator
Available in BK, RE, or CAM



Jack Handle Isolators
Available in RE, RB, YL, or BK



Part No. KU70056BK
3/4" D-Ring Isolator
Available in RE, RB, YL, or BK

Recovery Accessories

Part No.	Description
KU70039	Roller Fairlead Winch Isolator, Black, Red, or Camouflage
KU70046	Hawse Fairlead Winch Isolator, Black or Red
KU70047	Jack Handle & Winch Isolator Combo Pack, Black or Red
KU70054	Rope Rollers for Winch Roller Fairleads, Black or Red
KU71071	Jack Handle Isolator, Black, Red, Yellow, or Blue
KU70056	D-Ring Isolators, Black, Red, Yellow, or Blue
KU71074	D-Ring Washers for Use with D-Ring Isolators, Red or Black

Add BK for Black, CAM for camouflage, RE for Red, YL for Yellow, and RB for Royal Blue to the end of each part number to select color.

Part No. KU70046BK
Hawse Fairlead Winch Isolator
Available in BK or RE



Part No. KU70054RE
Roller Fairlead Rope Rollers
Available in BK or RE



Vehicle Recovery Straps and Tow Straps

"Don't Get Stuck Without It!"™

- Simply the best way to rescue a stuck vehicle
- Hi-Test™ abrasion-resistant webbing exceeds the needs of demanding applications
- Lighter than chain, won't rust, rot, or mildew and stores in trunk, job box, or behind truck seat



Super Heavy-Duty Recovery Straps

- 37,500 lbs. maximum vehicle weight
- 75,000 lbs. webbing capacity
- Comes in its own storage bag

Part No. 02970 - 30' x 6" HD Recovery Strap

Part No. 02980 - 30' x 6" HD Recovery Strap

Part No. 02990 - 30' x 6" HD Recovery Strap

Part No.	Break Strength	Size/Description
02815	12,000 lbs.	2" x 15' Emergency Tow Strap/Forged Hooks
02825	12,000 lbs.	2" x 25' Emergency Tow Strap/Forged Hooks
02858	8,700 lbs.	3/4" x 16' Emergency Tow Rope/Forged Hooks
02859	12,000 lbs.	7/8" x 18' Emergency Tow Rope/Forged Hooks
02922	15,000 lbs.	2" x 20' Vehicle Recovery Strap
02923	20,000 lbs.	2" x 30' Vehicle Recovery Strap
02932	22,500 lbs.	3" x 20' Vehicle Recovery Strap
02933	30,000 lbs.	3" x 30' Vehicle Recovery Strap
02943	40,000 lbs.	4" x 30' Vehicle Recovery Strap
02963	60,000 lbs.	6" x 30' Vehicle Recovery Strap
02952	20,000 lbs.	2" x 6' Winch Strap/Tree Saver
02953	30,000 lbs.	3" x 6' Winch Strap/Tree Saver



Jack Strap Handle Holder

We now offer the better holder – the "Jack Strap" Hi-Lift-style jack securer. It keeps your jack from rattling - or what have you - while traveling.

- Fits Hi-Lift-Style off-road jacks
- Stays on the jack all the time, because our design allows the handle to complete its ratcheting cycle
- Other designs have to be taken off to allow the jack to move upward
- The perfect solution for a persistent problem

Part No. 99466
Add "G" For Black
Add "R" For Red



Hi-Lift®

NEW

Lifts, Winches, Clamps, and More



Jack Hood Mount Kit

Mounts directly to existing hood hinge holes, no drilling required.

- Part No. HM800 - 07-15 Wrangler JK
- Part No. HM825 - 96-06 Wrangler TJ
- Part No. HM850 - 87-95 Wrangler CJ/YJ
- Part No. HMLK - Mount Locks



Neoprene Jack Cover

Keep your Hi-Lift Jack's lifting assembly protected from mud, dirt, and road grime.

Part No. NJC



Adjustable Tube Mount

Mount your Hi-Lift Jack to tube bumpers, bull bars, roll cages, or roof racks. Models fit tubing sizes 1"-3".

- Part No. TM700 - Fits 1" to 2" Tubing
- Part No. TM750 - Fits 2" to 3" Tubing



Lift-Mate

Lift from the wheel instead of the bumper.

Part No. LM100



Off-Road Base

Prevent your Hi-Lift Jack from sinking on soft terrain.

Part No. ORB



HandleKeeper

Hold your jack in place and eliminate rattling during transportation.

- Part No. HKB - Black
- Part No. HKR - Red



Off-Road Kit

Everything you need to winch with the Hi-Lift Jack in one convenient gear bag.

Part No. ORK



4XRAC

Secure your Hi-Lift Jack before you go off-road.

Part No. 4X400



Jack Protector

Protect your Hi-Lift Jack from the elements with this weather-resistant soft case.

Part No. JP350



Bumper Lift

Use your Hi-Lift Jack to easily lift vehicles with curved bumpers.

Part No. BL250



Fix-It-Kit

Everything you need to service your Hi-Lift Jack.

Part No. FK1



Hi-Lift X-TREME Jack

Hi-Lift Cast/Steel Jack

Hi-Lift All-Cast Jack

Hi-Lift Patriot Edition Jack

Hi-Lift X-TREME Jack

- Charcoal metallic powder-coat finish
- Gold zinc-coat hardware ensures the greatest rust resistance from extreme use
- Unique winch-clamp-spreader attachment replaces the clamp-Clevis of standard Hi-Lift®
- Winch, clamp, or spread up to 5,000 lbs.
- One position for all winching, clamping and spreading positions

Part No. XT485 - 48" Part No. XT605 - 60"

Hi-Lift Cast/Steel Jack

- Made of cast and stamped high-strength steel parts
- 7000 lbs. (3175.14kg) tested capacity

Part No. HL424 - 42" Part No. HL484 - 48" Part No. HL604 - 60"

Hi-Lift All - Cast Jack

- High-yield and tensile-strength iron castings
- 7000 lbs. (3175.14kg) tested capacity
- Most durable design

Part No. HL425 - 42" Part No. HL485 - 48" Part No. HL605 - 60"

PATRIOT EDITION

- This uniquely themed red, white, and blue top-of-the-line all-cast Hi-Lift Jack comes standard with a red Hi-Lift Handle Keeper

Part No. PAT485 - 48" All Cast Part No. PAT605 - 60" All Cast

Reflective Recovery Straps

Ideal for winching and recovery use with a Hi-Lift® Jack, these straps utilize a polyester material for a controlled pull and to reduce dangerous recoil. The reflective loops make night recovery easier by increasing the visibility of both connecting points. Use in any towing/recovery situation.

- Part No. STRP230 - 2"x30'
- Part No. STRP315 - 3"x15'
- Part No. STRP330 - 3"x30'

NEW





Standard Manual Hubs

Our reputation for quality and innovation is unmatched in the industry.

- Designed to fit most 1/2, 3/4 and 1 ton 4WD vehicles
- Same quality as original equipment hubs
- Features chrome-plated or painted housings and sure-turn dials for easy engagement
- Installation time is less than 1 hour per set. Guaranteed for life

Standard Manual Hub Part No.	Standard Hub Service Kit Part No.	Year	Spline Count	Application
28751	—	81-86	27	CJ, Universal Scrambler (5 Bolt)
9790	11967	74-91	19	Full-Size Wagoneer, Cherokee, J-10 Pickup, Commander
9790	11967	77-87	19	J-20 Pickup



Supreme Hubs

Chrome

The chrome appearance is the ultimate in style and service. Available for most domestic and import applications, it features the latest patented technology and decidedly smooth operation with a limited lifetime warranty.



Stainless Steel

Made by die-casting aluminum into a pre-made stainless jacket, these hubs provide lightweight strength and corrosion resistance. It uses the ultimate combination of materials for the cap of a locking hub.

Chrome Part No.	Stainless Part No.	Application
104	302	74-80 J10 Pickup
104	302	78-90 J20 Pickup
104	302	74-87 Wagoneer, Cherokee



Premium Manual Hubs

Best selling hubs in the world. Made in the U.S.A.

- Made of new ZA27 super alloy body and durable, all-metal components
- First choice for most 4WDs manufactured today
- Longer clutch-ring spline teeth and body spline area for better load handling
- Larger body wall thickness to optimize clutching strength
- Corrosion-resistant, chrome-plated finish for long-lasting performance

Premium Manual Hub Part No.	Premium Hub Service Kit Part No.	Year	Spline Count	Application
29062	7300	71 and Prior	10	CJ, Universal, M38A1, Willys
9062	7300	72-80	27	CJ, Universal (6 Bolt)
29062	7300	66-71	10	Jeepster C101 Commando
9062	7300	72-73	27	Jeepster C104
29062	7300	73 and Prior	10	Gladiator, Wagoneer, Pickup
20990	20825	74-91	19	Full-size Wagoneer, Cherokee, J-10 Pickup, Commander
9072	7302	72-76	19	J-20 Pickup (Heavy Axle)
20990	20825	77-87	19	J-20 Pickup
29062	7300	65 and Prior	10	Jeep Station Wagon, Pickup



Premium Hubs

Made from corrosion-resistant aluminum with cast-iron drive components, Superwinch premium hubs will give you a lifetime of dependable service.

Part No.	Application	Spline Count
400526	81-86 Jeep® CJ, Universal	27
400518	74-90 Jeep® J-10 Pickup	19
400518	77-90 Jeep® J-30 Pickup	19
400518	74-90 Jeep® Wagoneer, Cherokee	19

Class I Sportframe

- 1-1/4" square receiver tube opening
- Comes complete with removable drawbar, pin, and clip

Class II Frame Hitch

- 1-1/4" square receiver tube opening
- Receiver-style hitch with removable drawbar
- Includes drawbar, pin, and clip

Class III & Max-Frame™ Receivers

- 2" square receiver tube opening
- Max-Frame receivers are designed for customers with trucks, vans, and sport utility vehicles
- Designed for today's stylish sport utility vehicles, round tube receivers complement vehicle appearance

Class I Part No.	Class I TW/GTW	Class II Part No.	Class II TW/GTW	Class III Part No.	Class III WC/WD	Application
—	—	—	—	75796	5,000/6,000	14-2016 Jeep Cherokee
24557	200/2,000	—	—	—	—	87-95 Wrangler YJ
24631	200/2,000	36238	300/3,500	75193	4,000	97-06 Wrangler TJ
—	—	—	—	75515	3,500/4,000	07-14 Wrangler JK



Self-Locking Adjustable Hitches

- Spring loaded stainless anti-rattle balls
- Aircraft grade high strength billet aluminum body
- Chrome plated one-piece double ball
- O-ring sealed stainless integral pins
- Integrated dual self lock with barrel type keys and rubber seals

Part No.	Description
DTALBM6400	2" Shank / 4" Drop / 5" Rise / 2" & 2-5/16" Balls
DTALBM6600	2" Shank / 6" Drop / 7" Rise / 2" & 2-5/16" Balls
DTALBM6800	2" Shank / 8" Drop / 9" Rise / 2" & 2-5/16" Balls
DTALBM7000	2" Shank / 10" Drop / 11" Rise / 2" & 2-5/16" Balls



Get the Right Wiring Kit Plug-In Simple!® Vehicle Wiring Kits

- No cutting or splicing
- Easy Do-It-Yourself, includes everything needed to complete installation to a 4-wire flat trailer connector
- Weatherproof SAE Design
- Modular 2-Piece System — 4-wire flat can be replaced if damaged. No need to replace entire unit

- Part No. 42635 - 07-16 Wrangler
- Part No. 42625 - 05-06 Wrangler
- Part No. 42615 - 98-04 Wrangler
- Part No. 56200 - 07-16 Wrangler

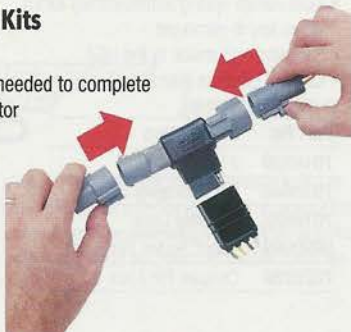

T-One® Connectors

T-One® Connectors require no splicing of vehicle wires. Simply locate your vehicles' wiring harness connector, unplug the connection, and insert the T-One Connector into the vehicle's harness. No special tools required.

118000 Series

Adjustable Tow Bars

5,000 Lbs. Adjustable Tow Bar Lightweight, Only 31 lbs.

- Arms adjust from 26" to 41" for universal fit
- Tow bar mounting brackets bolt securely to vehicle bumper (almost all applications will require a custom fabricated bracket due to bumper design)

Part No. 63180 - Adjustable Tow Bar, 5,000 lbs. GVW, Including Mounting Brackets

NOTE: Total weight of towed vehicle must not exceed 5,000 lbs. or must not exceed the weight of the towing vehicle.



Wrangler Tow Bar Baseplates

Our baseplates are designed specifically to respect the beauty and design of your Jeep®. On most, they won't protrude out, hang below or rise above your bumper or grill. Bolts permanently to the chassis of the towed vehicle and provides a secure, reliable attachment point for tow bars. Demco believes baseplates should be "... accessible, but not visible."

- Part No. 9518292 - 07-16 Wrangler; 2 or 4 Door
- Part No. 9518045 - 97-06 Wrangler (Sport, Sahara, Rubicon, Unlimited)

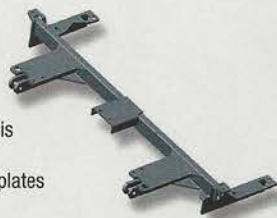



Replacement Drawbar Kits Rated 300lbs. TW / 3,500lbs. WC

- Class II, 1-1/4" Receiver
- Includes Pin and Clip



Part No.	Description
36051	7" Length, 5/8" Rise, 1-1/4" Drop, 3/4" Hole
36053	9-3/4" Length, 5/8" Rise, 1-1/4" Drop, 3/4" Hole
36061	9-3/4" Length, 3-1/8" Rise, 3/4" Hole
36063	11-3/4" Length, 3-1/8" Rise, 3/4" Hole
36065	10" Length, 5" Rise, 3/4" Hole
36071	7-3/16" Length, 2-5/8" Rise, 3-1/4" Drop, 3/4" Hole
36078	7-3/8" Length, 4-3/4" Drop, 3/4" Hole

Class III Ball Mounts

Part No.	Shank					Capacity
	Hole	Length	Rise	Drop		
40342	1"	8-1/2"	3/4"	2"		600/6,000
40343	1"	10-1/2"	3/4"	2"		600/6,000
40344	1"	9"	2-3/4"	4"		600/6,000
40345	1"	11"	2-3/4"	4"		600/6,000
40346	1"	9-1/2"	4-3/4"	6"		600/6,000



Ball Mount Kits

- Class III, 2" Receiver
- Weight Carrying: 600/6,000lbs. (TW/GTW)
- Includes Ball Mount and Clip

Part No. 2923 - 8-1/2" Length, 3/4" Rise, 2" Drop
Part No. 2953 - 9" Length, 2-3/4" Rise, 4" Drop



Hitch Balls

The hitch ball diameter (A) must be the same diameter as the trailer coupler (1-7/8", 2", or 2-5/16"). The shank diameter (B) of the hitch ball should be the same as the hole diameter in the ball mount. The shank length (C) should be long enough to allow at least two threads to be visible when the hitch ball is installed and the nut completely tightened.



Zinc Part No.	Chrome Part No.	Ball Dia. (A)	Shank Dia. (B)	Shank Length (C)	Ball Mount Thickness	GVWR Rating
63811	63810	1-7/8"	3/4"	1-1/2"	3/8"-5/8"	2,000
63817	63816	1-7/8"	1"	2-1/8"	3/8"-3/4"	2,000
63821	63820	2"	3/4"	1-1/2"	3/8"-5/8"	3,500
63848	63845	2"	1"	2-1/8"	3/8"-3/4"	6,000
63831	63830	2"	1-1/4"	2-3/4"	3/8"-1"	8,000



BREAKTHROUGH ONE-KEY LOCK TECHNOLOGY

Jeep® Spare Tire Lock



Part No. 5922986
97-16 Wrangler

JK Hood Lock

- Eliminates hood flutter
- Rivets into existing holes and secures your under hood items from theft
- Opens With Your Jeep® Wrangler ignition key
- Plate tumbler sidebar to prevent picking and bumping
- Stainless steel lock shutter to keep out dirt and moisture
- Limited Lifetime Warranty

Part No. 7026128 - 07-16 Wrangler

Locking Hi-Lift Jack Mount for JK and TJ

- Works with your Wrangler ignition key
- Available in black or red
- Designed for driver or passenger side
- Designed for all Hi-Lift jack models
- Designed for convenient security with bolt lock
- Heavy steel construction
- Proudly USA built



Part No. 7028648 - Black, Driver Side
Part No. 7028650 - Red, Driver Side
Part No. 7028649 - Black, Passenger Side
Part No. 7028651 - Red, Passenger Side

Assorted Locks Works With YOUR Vehicle's Key! Fits 90-16 Jeep®

- Insert your key, turn once, lock learns your key
- No extra keys to carry or lose
- Automotive grade security and corrosion resistance
- Auto-return spring automatically locks when key is removed
- Patented and made in the USA
- Limited Lifetime Warranty



Part No.	Description
7018520	2" Padlock
7018448	5/8" Receiver Lock
7018452	6' Cable Lock
5922986	Jeep® Spare Tire Lock
7025286	Coupler Pin Lock



Spare Tire Cargo Basket

Jeep® Wrangler

- Store your cargo out back with the Surco Spare Tire Cargo Basket
- Attaches to your vehicle's spare tire mount
- Heavy-duty backing plate fits standard bolt pattern tire mounts
- Carrier slides on and off the mount tube for quick and easy removal
- Crafted of heavy-duty 3/4" thick square aluminum tubing
- Black powder coat finish looks great and resists corrosion
- Measures 19" L x 43" W
- No drilling required



Part No. SJ4319

Safari Rack

- Basket is 5" deep
- Made with 3/4" aluminum square tubing
- Durable black powder coat finish
- Easily assembled, no drilling required
- Fits any factory rack (see application guide)
- Must have adapter to attach to vehicle
- Available in numerous sizes

- Part No. S4050 - 40" x 50"
 Part No. S4550 - 45" x 50"
 Part No. S5050 - 50" x 50"
 Part No. S5072 - 72" x 50"
 Part No. S4560 - 45" x 60"
 Part No. S5060 - 50" x 60"
 Part No. S5084 - 50" x 84"



Safari Floor Kit



- Add additional floor slats to solidify your Safari Rack
- Durable black powder coat finish

Refer to application guide for part numbers and adapters

Safari Crossbars



- For proper size refer to application guide
- Comes in set of two crossbars
- Durable black powder coat finish

Jeep® Wrangler Adapters



- No drilling required for easy removable application
- Securely attaches to Jeep® Wrangler hard top
- Works with Safari and Urban rack crossbars
- Durable black powder coat finish
- Patent Pending

- Part No. J400 - 87-95 Wrangler YJ
 Part No. J500 - 97-06 Wrangler TJ
 Part No. J600 - 07-12 Wrangler JK

Safari Rack Accessories

Safari Hi-Lift Jack Adapter

- Secures Hi-Lift jack onto rack
- Mounts to outside of rack not compromising storage space
- Durable black powder coat finish

Part No. 1108

Safari Spare Tire Adapter

- Holds spare tire on top of rack
- Lockable with pad lock (not included)
- Durable black powder coat finish

Part No. ST100

Safari Light Adapters

- Holds any PIAA, Hella, and all other brand lights
- Durable black powder coat finish

Part No. LT100 – Safari Rack

Safari Axe and Shovel Carrier

- Secures axe and shovel onto rack
- Mounts to outside of rack not compromising storage space
- Durable black powder coat finish

Part No. AX100



Urban Rack



- All aluminum construction
- Round corners coated with black powder coat paint
- Basket is 4" deep
- Easily assembled, no drilling required
- Fits any factory rack (see application guide)
- Available in numerous sizes
- Large floor for added support

- Part No. UB5050 - 50" x 50"
 Part No. UB4050 - 40" x 50"
 Part No. UB4550 - 45" x 50"

- Part No. UB4060 - 40" x 60"
 Part No. UB4560 - 45" x 60"
 Part No. UB5060 - 50" x 60"

Hard Top Carriers

- Easy lightweight space-saving design
- Durable black powder coat finish
- Soft contact points: rubber/urethane/vinyl
- 4 wheels (2 locking) for easy maneuverability
- HT200 adjusts to fit all Jeep® models and years

Part No. HT200 – Jeep® Wrangler Hard Top



Stud Anchors



Part No. 3511 - Double Part No. 3510 - Single

Cargo Track End Cap



Part No. 3515
 Cargo Track End Cap

2007 - 2016 Jeep® JK Products

Aluminum Congo Accessories Complete Custom Load Configuration Available for Congo Pro and JK Lo-Pro Systems



Part No.	Description
60335	1 Aluminum Load Bar 60"
60320	2 Stand-Off Bracket 2"
60321	Stand-Off Bracket 1-5/8" (Fits First Gen Congo)
60245	3 Aluminum Grab Handle Kit 2"
60250	Aluminum Grab Handle Kit 1-5/8" (Fits First Gen Congo)
60325	4 2" - 1.13" Cross Over Clamp
60330	1-5/8" - 1.13" Cross Over Clamp (Fits First Gen Congo)

Light and Versatile Rust-Proof Gray Anodized Finish.

YAKIMA®

TAKE MORE FRIENDS™



SpareRide™ Spare Tire Dual Bike Rack

The SpareRide attaches directly to the spare tire's mounting bolts for a secure, snug fit. Yakima's SuperCush anti-sway cradles and removable ZipStrips help provide stability and eliminate bike-to-bike contact. Bike arms easily fold down when not in use. SpareRide comes with 2 integrated bottle openers on the bike arms, a locking SKS Tightening Knob and a 5' SKS Locking Cable for complete security.

Part No. 8002599



42" Hardtop Track Kit For 07-16 Wrangler

Complete track system ready to install to fiberglass tops. Kit includes Control Tower (4 pack), Landing Pad (2 pairs), 58" crossbars, and 42" tracks with CapNut hardware.

Part No. 8001616

MOD-RAK EXP Modular Aluminum Extended Platform, Heavy Duty, Traction Surfaced



Part No.	Description
55075	1 Mod-Rak Exp - 55-1/2" W x 78-1/2" L
60240	2 Grab Rails 24" - 1-1/8" dia.
60200	3 K-Rail 54" - 1-5/8" dia.
60210	4 K-Rail 48" - 1-5/8" dia.
55015	5 Congo Pro A-Frame JK (Windshield Frame Mounted Load/Light Bar Part of the CONGO PRO)

Tough Black Powder Coat Finish.

MegaWarrior

Ginormous MegaWarrior rooftop cargo baskets are great for carrying heaps of things – like bikes, skis, boats, luggage, spare tires, shovels, and back-seat drivers who won't pipe down on long road trips. (Okay, maybe not that last one.)



Part No. 8007080 - 52" x 48" x 6.5"

Part No. 8007070 - LoadWarrior 44" x 39" x 6.5"

Spare Tire Carrier

Everybody knows the best place to carry a spare tire is in your cargo basket (as opposed to around your waist).

Part No. 8007076 - Up to a 35" Tire



Hi-Lift Jack Carrier

Jacks tend to be greasy and dirty and are best carried on your basket instead of the inside of your car. (Sorry to stereotype those of you who happen to be named Jack.)

Part No. 8007077

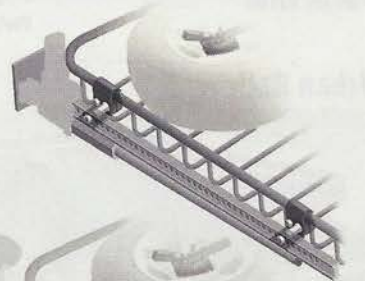

Axe/Shovel Bracket

Hey, you never know when you're going to need to build a log cabin and/or dig a latrine.

Part No. 8007078

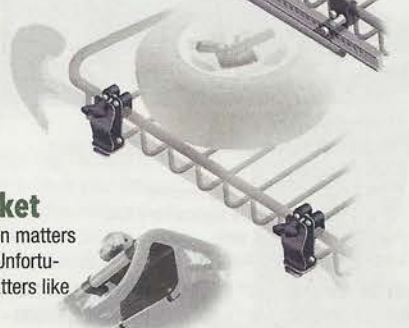

Light Mounting Bracket

These handy brackets shed light on matters in and around your cargo basket. Unfortunately, they don't shed light on matters like the meaning of life, though.

Part No. 8007075

2007 - 2016 Jeep® JK Products

JK Lo-Pro Roof Rack System 4 Door Ultra Low-Clearance!



Part No.	Description
55040	1 JK Lo-Pro Roof Rack System 4 Door
60235	2 Grab Rail (1-1/8") 48" Long
60360	3 Aluminum Fence Kit JK Lo-Pro: Fits Mod-Rak Lo-Pro
60300	4 Large Light Mount Kit 2"
60255	5 Kat Walk JK

Modular Roof-Mounted Loading System. Strong Internal Steel Bracing. Tough Powder Coated Finish.

Congo Pro JK Rugged 2" Steel Tubular Exo-Skeleton Rack System



Part No.	Description
55000	1 Congo Pro JK 4 Door Kit
55010	1 Congo Pro JK 2 Door Kit
55060	2 Mod-Rak JK Stealth Kit: Cargo Platform - 38" x 62" Traction Surfaced

Tough Black Powder Coat Finish.



JK Access Systems Door Mounted Hinge Step and Rocker Walks. Sturdy and Safe Footing.

2007-2015 Jeep® JK 2 and 4 Door

Part No.	Description
60260	1 Hinge Step (sold in pairs)
56000	2 Rocker Walk JK 4dr
56010	2 Rocker Walk JK 2dr

This new line up is all about convenient access to the high places on your Jeep®!
Dual Purpose Running Board/Rocker Guard System, Jeep® JK.

Jeep® is a registered trademark of FCA US LLC. More Applications Available.

First Generation Congo Cage and Safari Basket



The Congo Cage is rock solid, made with 1 5/8" dia. high tensile strength steel tubing. No-Drill installation makes this system perfect for the do-it-yourselfer. Epoxy zinc primer and marine grade black powder coat provide a durable and corrosion resistant finish. Hit the trail or the beach with a **Kargo Master Congo Cage**.

Jeep® Congo Cage

Part No.	Description
50301	For CJ7 and YJ up to 1995
50311	For TJ 1997 and Up
50311	For TJ Unlimited 2005+
50341	For 2007 + JK 2 Door
50351	For 2007 + JK 4 Door

Our stylish and durable Safari Basket racks are the best way to contain and transport the gear you need for big adventures. The 4" deep basket is highly crafted from 1" round steel tubing. Floor rails are made from lightweight rust proof 1" square aluminum tubing. Epoxy zinc primer and a marine grade black gloss powder coat provide a handsome, durable and rust resistant finish. These racks are sized to mount perfectly on our Congo Cages and to maximize the above roof carrying capacity of your Jeep® or SUV.

Bushman Steel Safari Baskets

Part No.	Description
50201	42" W x 50" L
50231	52" W x 60" L
50241	52" W x 50" L
50251	52" W x 74" L

Safari Basket Mount Kits

Part No.	Description
50561	Mounts to Congo Cage
50541	Mounts to Most Rain Gutters (4" above gutter)
50501	Mounts to Jeep® "Roll Bar"
50721	Mounts to Fiberglass Top
50551	Extra Tall Rain Gutter Mounts (5" Above Gutter)
50611	Mounts to Luggage Rack Rails With Top Crossbar Opening
50621	Mounts to Some Cherokee And Grand Cherokee
50631	Mounts to Luggage Rack Where Crossbar Channel Opens In

Safari Basket Accessories

Part No.	Description
60081	Side Mount Light Brackets
60180	Front Mount Light Brackets
60091	Spare Tire Bracket Kit
60061	Brackets to Mount Yakima Load Bars on Safari Rack
60101	Axe or Shovel Mounting Brackets
60111	High Lift Jack Mounting Brackets



Part No. 834 - Hull-a-Port™



Part No. 599XTR - Big Mouth™



Part No. 92725
Universal 6 Pair Ski Carrier™



Part No. 916XTR
T2 Hitch Bike Carrier™



Part No. 990XT - Doubletrack™



Part No. 9006XT - Gateway™



Part No. 963PRO - Spare Me™



Part No. 9031 - Vertex™ Swing



Part No. 9029 - Vertex™ 4 Bike



Part No. 9043 - Helium Aero

Watersport Carriers

Thule's watersport carriers provide the best carrying options for your kayak or canoe. Thule carriers include heavy-duty straps, Buckle Bumper™ to protect your car from scratches and tie-downs to secure your rig.

Part No.	Product Description	Factory Rack Compatible	Xsporter Compatible	Yakima Compatible
834	Hull-a-Port™	Yes	Yes	Yes
881	Top Deck™	Yes	Yes	Yes
883	Glide and Set™	Yes	Yes	Yes

Bike Carriers

Thule's bicycle carriers give you the confidence to carry your bikes while protecting your car from scratches.

Part No.	Mount Type	Factory Rack Compatible	Xsporter Compatible	Yakima Compatible
526XTR	Fork Mounted	Yes	XADAPT1	Yes
516XTR	Fork Mounted	w/532	XADAPT1	Yes
594XT	Upright	Yes	XADAPT1	Yes

Strap Rack Bike Carriers

Part No.	Product Description	Capacity Attachment	Anti-Sway Included	Bike Lock
910XT	Passage™	Up to 2 bikes	Yes	No
911XT	Passage™	Up to 3 bikes	Yes	No
9006XT	Gateway™	Up to 2 bikes	Yes	No
9007XT	Gateway™	Up to 3 bikes	Yes	No
963PRO	Spare Me™	Up to 2 bikes	Yes	Yes

Hitch Cargo Carriers

Utilize your 2" or 1-1/4" receiver hitch to store all your extra gear. The Transporter Combi™ offer 13 cu. ft. of cargo capacity, impact and UV resistant ABS construction and Thule One Key™ System locks.

Part No. 665C - Transporter Combi™

(Fold Down Base - Matte Black finish - 2" or 1-1/4" receivers)



Rack and Carriers

Thule hitch carriers provide the most options to get your bikes on the road. From our premium T2 carriers, to our value packed Parkway series, Thule hitch carriers feature heavy-duty construction, easy-to-use features and a lifetime warranty.

Part No.	Description
9034 T2 Pro	2 Bike (2" rec.)
9035 T2 Pro	2 Bike (1.25" rec.)
9036 T2 Pro	2 Bike Add-On (2" rec.)
9044 T2 Classic	2 Bike (2" rec.)
9045 T2 Classic	2 Bike (1.25" rec.)
9046 T2 Classic	2 Bike Add-On (2" rec.)

Part No.	Capacity	Rear of Vehicle / Platform	Folding Arms Included	Bike Lock
990XT	2	Platform	Yes	Yes

Helium Aero™ - Ultra-Light Aluminum Hitch Rack

9043 (1¼" or 2")	3	Tilt Down	Yes	Yes
9042 (1¼" or 2")	2	Tilt Down	Yes	Yes

Apex™ Swing - Swing Away Carrier With All The Features You Need

Loaded Swing				
9027 (2")	4	Away	Yes	Yes

Apex™ - Fold-Down Carriers With All Locks Included

9025 (1¼" or 2")	4	Tilt Down	Yes	Yes
9026 (2")	5	Tilt Down	Yes	Yes

Vertex™ Swing - Swing Away Carrier With All The Features You Need

Loaded Swing				
9031XT (2")	4	Away	Yes	No

Vertex™ - Fold Down Arms And Rear Vehicle Access

9029XT (1¼" or 2")	4	Tilt Down	Yes	No
9028XT (1¼" or 2")	2	Tilt Down	Yes	No
9030XT (2")	5	Tilt Down	Yes	No

Parkway™ Series - Rear Of Vehicle Access

956 (2")	4	Tilt Down	No	No
957 (1¼")	4	Tilt Down	No	No
958 (2")	2	Tilt Down	No	No

Overhead Storage Console



- Constructed from durable blow-molded High-Density polyethylene
- A non-skid pad is adhered to the inside of the console to help keep your gear from sliding around, and a mesh storage net helps keep it safely stowed yet easily accessible
- Measures 41.5"x2.5"x6.5" and offers more than 450 sq. cubic inches of storage

Part No. 1355114 - 07-14 Wrangler



Rear Seat Cargo Organizer

The perfect organization solution for your Jeep®. The new Rugged Ridge Rear Seat Organizer features storage areas to organize wayward trash, toys, drinks, iPods and other clutter. Each organizer is designed to instantly fit into the rear cup holders of your 2011 to 2016 Jeep® Wrangler and includes a lid with integrated hinge to keep objects from flying out when the top is down. Patent Pending.

Part No. 1355150 - 11-16 Wrangler JK

Cargo Bag

Rugged ridge has the answer for your onboard storage needs. These soft side storage bags feature heavy canvas construction and oversized zippers. Great for carrying recovery gear, spare parts, camping gear, clothes, or any other necessity for a wheeling trip. Rugged nylon straps keep the bags in place during even the most insane wheeling. Make the most out of your roll cage with a full complement of Rugged ridge storage bags. These bags are easy to install and take off and work with both hard tops and soft tops.

Part No. 1355101 - 97-15 Wrangler JK



VERTICALLY DRIVEN PRODUCTS

315 Ultimate Locking Console

Features two sets of deep cup holders for front and rear, lined sunglass holder and spring activated coin holder. Large padded armrest. Removable 6 can cooler. Locking hidden storage area for CDs and cassettes. Does not interfere with "fold and tumble" rear seat.



Part No. 31501 - Black Vinyl

Super Siphon

- Made of acetyl plastic - resistant to gasoline or any other hazardous chemicals
- Self priming siphon with 5.5' of hose
- No more sucking - just shake it to start siphon
- Moves 1.5 gallons per minute

Part No. 3506



Overhead Storage Console 87-16 Jeep® Wrangler YJ, TJ, JK and Unlimited

- Instantly turns the area between your sport bars into usable storage space without any interference or modifications to your vehicle
- Made in the USA

Part No. 31700



Modular and Stubby Bumper End Cap Kit

- Rugged and beefy appearance, as well as improved tire clearance with VDP's do-it-yourself kit
- Made of indestructible Linear Low Density Polyethylene
- Reduces your bumper width by 17.5"
- Includes easy to follow instructions and mounting hardware

Part No. 31550 - 07-16 JK Wrangler - Stubby

Part No. 31555 - 07-16 JK Wrangler - Modular



Stubby



Modular

Storage Vault

- Keep your valuables safe when the top is off and the doors are unlocked
- Hidden below the rear cargo floor carpet
- Bolts to Jeep® body inside Storage Vault
- 16 Gauge Steel lid and stainless steel piano hinge

Part No. 32501 - 07-11 JK Wrangler



500 Seat Console

- Freeze chiller and place in console to keep drinks cold all day
- Includes map net under lid
- Rear storage holds canned drinks or any combo
- Erasable writing board with pen and eraser
- Deep jumbo cup holder

Part No. 50023 - Charcoal



Overhead Sound Wedges

- Unbelievable sound
- Made from rugged weather resistant textured plastic
- Includes all mounting hardware, instructions, and wiring

Part No. 793501 - 03-06 TJ Wrangler



Overhead Jeep® Sound Bars

Part No. Application/Color
87-02 Jeep® YJ/TJ Wrangler

792501 Ultimate VI — 6 Speaker — Black Textured Plastic

792511 Ultimate VI — 6 Speaker — Gray

792515 Ultimate VI — 6 Speaker — Denim Black

792517 Ultimate VI — 6 Speaker — Spice/Tan

792115 Supreme — 2 Speaker Covered — Denim Black

792201 Deluxe — 2 Speaker Textured Plastic — Black





Bestop
Fit. Function. Style.

Part No.	Application
4250101	07-16 Wrangler Unlimited
4250301	11-16 Wrangler

Pet Barrier for Jeep®

- Designed to keep your dog safely in the back of the vehicle
- The only Pet Barrier that works with a Jeep soft top with a rattle-free fit
- Manufactured from high quality steel tubing and welded mesh, guaranteeing lifelong durability



Modular Rack System

- 43" x 23" x 4" universal rack tray made of sturdy plastic, lighter than steel, better impact resistance, and doesn't rust
- Use the tailgate rack bracket and the lower cargo rack bracket simultaneously
- Holds up to 75 lbs. of gear per tray
- Universal rack tray requires rack bracket (sold separately) to install
- Available for TJ, JK 86-10

Part No.	Application
4141101	Tailgate Rack Bracket for Wrangler and Wrangler Unlimited 86-06
4141201	Tailgate Rack Bracket for Wrangler and Wrangler Unlimited, 07-16
4143701	Lower Cargo Rack Bracket for Wrangler, 03-16
4144401	Universal Rack Tray

Locking Storage Boxes and Consoles



- Attaches conveniently beneath the driver's seat using OEM seat riser bolts
- Excellent location to conceal valuables
- Does not interfere with driver's seat adjustment
- No-drill install
- Made of heavy-duty, 16-gauge carbon steel, with textured black powder coat
- Secures with high-tech, pick-resistant lock and comes with two keys
- TJ Box: Comes with locking cable, so box can be attached almost anywhere in almost any vehicle

Part No. 4264001 - 07-16 JK Box: Does not fit with 2011 Easy Access Driver's Seat.

Part No. 4264101 - 97-06 TJ Box: Does not fit with Easy Access Driver Tip and Slide Seat. (Jeep® Part No. 4264001)

Part No. 4264201 - 07-16 Wrangler Unlimited, Passenger side

Part No. 4264301 - 11-16 JK Wrangler, Locking Console



Instatrunk™

Patented Instatrunk™ secures and safeguards belongings out of sight.

- All steel construction
- Satin black powder coat



Part No.	Application
4270001	Wrangler, 86-95
4270101	Wrangler and Wrangler Unlimited, 97-06
4270201	Wrangler and Wrangler Unlimited, 07-10 for vehicle without factory Subwoofer
4270301	JK Wrangler, 11-16 with factory subwoofer



Utility Storage Box

- Completely open compartment for multi-use storage options or Tool box with slide out drawers, with non-slip liners
- Weather resistant, stainless key lock
- Durable powder coat gloss finish
- Heavy duty steel construction
- Fits traditional 5 gallon Gerry can mounts
- Exterior dimensions 18" x 13" x 6"

Part No. 86622 - Open Utility Storage box

Part No. 86619 - Tool box can with drawers





Daystar Cam Can

The NEW Award Winning Cam Can Trail Box is the most convenient and safe way to transport gear and tow ropes. The Cam Can system mounts in the center of spare tire or with a universal bracket.

- Durable design withstands rugged use
- Secure opening and locking system
- Easy Grip Handles
- Modular Hinged Design
- Lifetime Warranty



Part No.	Description
KJ71035BK	Non-Flammable Liquid - Kit Black NEW
KU71114BK	Non Flammable Liquid(Can Only) Black NEW
KU711140R	Trail Box, Orange (Trail Box Only)
KJ710350R	Trail Box, Complete Kit, Orange
KU71114RB	Potable water; Grey/Blue (Cam Can Only)
KJ71035RB	Potable water; Complete Kit, Grey/Blue
KU71114GN	Liquids such as Gear Oil (not Certified for fuel), Green (Cam Can Only)
KJ71035GN	Liquids such as Gear Oil (not Certified for fuel) Complete Kit, Green
KU71115	Single Plate Mount Kit
KU71116	Double Mount Kit



Dash Panels

A direct replacement for factory dash components, installation is a simple remove-and-replace operation.

Part No.	Description
KJ71039BK	11-16 Jeep® JK With Universal Ball Mount
KJ71034BK	11-16 Jeep® Wrangler JK Switch Panel, Black
KJ71034TN	11-13 Jeep® Wrangler JK Switch Panel, Tan
KJ71044BK	07-10 A Pillar Switch Pod Jeep® JK (With Switches Included)
KJ71031	97-06 Jeep® TJ Wrangler Upper Dash Panel



C3 (Configurable Cargo Covers) For JK

Keeping you on the-go with ease, the patent pending rear Configurable Cargo Covers (C3) offer complete protection for the rear cargo area of your Jeep. Protecting the carpet and plastic trim from damage, scratches, pet claws, dirt and other debris, will keep your Jeep™ looking pristine. Also creates a waterproof, pet-friendly space for long trips. Rugged Ridge C3 Rear Cargo Covers, ready for whatever.

- Allows for 60/40 split
- Built in front curtain keeps pets from entering front of Jeep
- Side retention system keeps cover in place



Part No.	Year	Description
1326001	07-14	4-Door; No Subwoofer
1326002	07-14	4-Door; With Subwoofer
1326003	07-14	2-Door; No Subwoofer
1326004	07-14	2-Door; With Subwoofer
1326001	15-16	4-Door
1326003	15-16	2-Door

JK Cargo Liners

Part No. 1297501 - Cargo Liner, Black, 07-10 Wrangler JK
 Part No. 1297503 - Cargo Liner, Black, 11-16 Wrangler JK



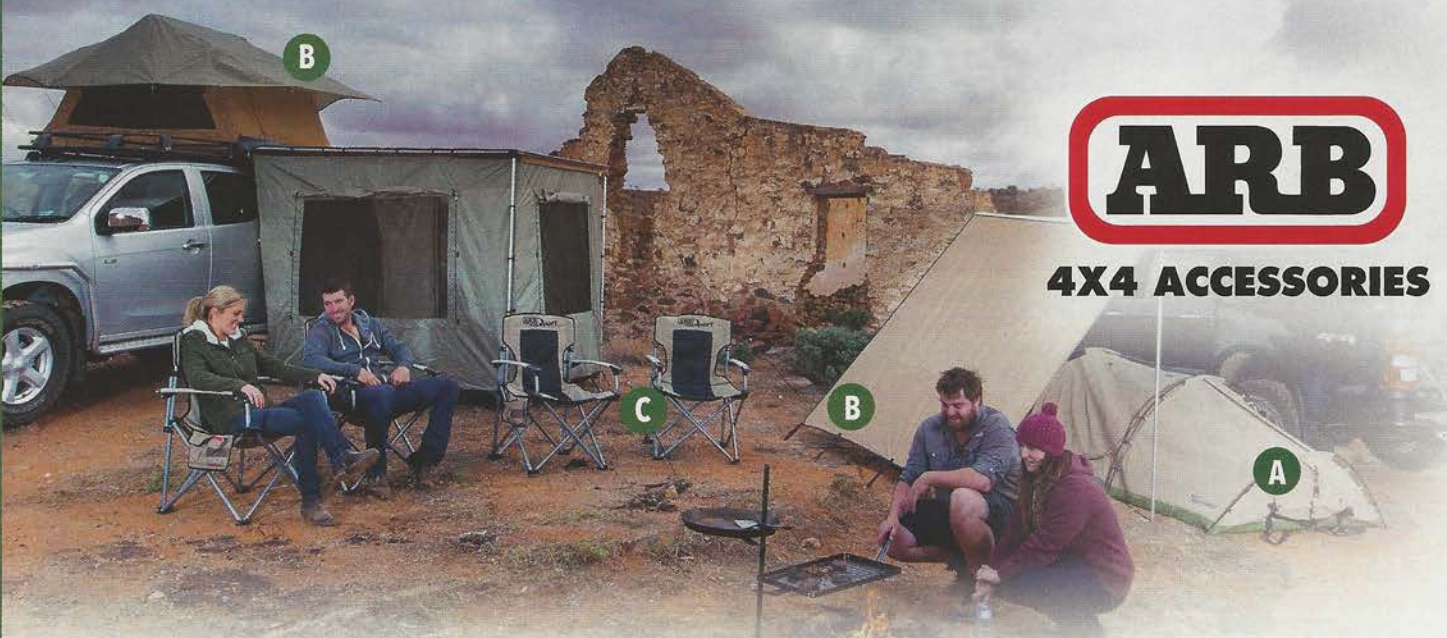

4X4 ACCESSORIES

A. Ground Swag Tents

- Waterproof - Suitable for all weather conditions
- Spacious - Available in both single and double widths
- Comfortable - Mattress included
- Freestanding - Fast set up with 3 poles and external clip system
- Saves space - Pillow and bedding are intended to be rolled up and transported inside swag
- Features pockets, key and flash light clips and wide brim hat holder
- YKK zippers throughout the swag design
- Rain gutters
- Head and foot awnings

Part No.	Description
SDS100	82.7" L x 35.4" W x 33.5" H
SDS200	82.7" L x 55.1" W x 31.5" H

B. Rooftop Tent & Awnings

- Strength, rigidity and water resistance
- Manufactured from high quality, poly/cotton fabric
- Sturdy aluminum retractable ladder
- High density bonded chip foam mattress with removable cover
- Insect screened windows and doors.
- UV stabilized laminated PVC cover
- 55 Inch Width x 94-1/2 Inch Long x 51 Inch High

Part No.	Description
ARB3201	Series III Simpson; Rooftop
4401A	98.43" x 98.43"
4402A	78.74" x 98.43"

C. Sport Camping Chair

Camping chairs on the market today are built to meet a price point, not built to last. ARB tested many chairs for strength and durability before finding a design that could stand up to the task. It features aluminum arm rests and a slightly larger form factor than the standard chairs on the market, but still compact enough to be folded and packed in a carry bag.

Part No. 10500100

D. Roller Drawer System

The 5012020 incorporates a single Roller Drawer and an integrated roller floor top. The design allows for plenty of accessible and secure storage in the drawer. While the roller drawer function is self-explanatory, the roller floor provides easy access to an ARB Fridge Freezer or other gear.

Part No. 5012020 - 07-15 Wrangler Unlimited



E. Fridge Freezers

- 100% CFC free, low ampere draw, ice free operation
- Recessed powder coated steel fixed carry handles
- Operates at extreme angles up to 30°
- Integrated battery protection system

Part No.	Description
10800352	37 Quart
10800472	50 Quart
10800602	63 Quart
10800782	82 Quart

TERAFLEX

Tailgate Table with Cutting Board

The large table is designed to provide maximum use while on the trail, and folds vertical when not in use. It is constructed from lightweight aluminum with stainless steel hardware and is rated for 75 Pounds of evenly distributed load capacity. The table also includes a polyethylene cutting board, trash bag hooks, and a bottle opener. Multiple slots and holes allow for attaching accessories to the underside.

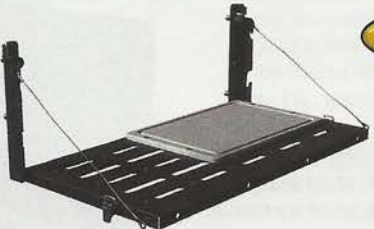

Part No. 4804180 - 07-15 Wrangler



First Aid Storage Bag

This First Aid storage bag consists of several individual pouches to store your first aid essentials. Attaches to the rollbars in (3) locations. Can be stored in an easy access location for emergency needs.

Part No. 769541





Warn WL Series LED Spot and Flood Lights

- Cutting edge optical design
- Refractec optics extract the maximum amount of light out of the latest generation Cree LEDs, while producing more overall effective lumens and candela
- 50,000+ hour LED lifespan
- Die-cast aluminum housing
- Durable polycarbonate lens
- Voltage protection
- Thermal management – heat sink
- IP68 waterproof rating
- Designed, engineered, and assembled in the USA
- Includes mounting hardware and harness

Part No.	Description
93910	4" Light Pod Spot – Single
93920	4" Light Pod Spot – Pair
93915	4" Light Pod Flood – Single
93925	4" Light Pod Flood – Pair
93930	6" Light Bar – Spot
93935	6" Light Bar – Flood
93940	10" Light Bar – Spot
93945	10" Light Bar – Flood
93950	20" Light Bar – Spot
93955	20" Light Bar – Flood
93965	Wiring Extension Kit – 3'
93960	Wiring Kit – Y adapter



Part No. 82405



Part No. 82420



Part No. 82425

W700D-HID Driving Lights

At 7" (17.8 cm) in diameter, these HID lights deliver outstanding range and spread and will blaze a trail of intense white light through the darkest off-road terrain. The Xenon HID bulb is 300% brighter—and lasts 10 times longer—than 55W halogens. Features include tempered clear glass lenses, vaporized aluminum over die-cast aluminum reflectors for outstanding light output, and impact and corrosion-resistant polymer cases for great weather resistance. The integrated ballast and wireless control switch allow for a straightforward installation.

Kit contains two lights, mounting hardware, wireless control, transmitter, wiring, rock guards, and covers.



W650D Driving Lights

These big 6.5" (16.5 cm) halogen lights deliver outstanding performance, great value, and are ideal for increased visibility on the trail. Features include 55W H3 halogen bulbs, hardened clear glass lenses, vaporized aluminum over steel reflectors for maximum output, steel cases with a powder-coated finish for great weather resistance, and a thin profile for increased mounting options. These lights also come with a wireless control switch for simple installation.

Kit contains two lights, mounting hardware, wireless control, transmitter, wiring, rock guards, and covers.



W650F Fog Beams

Designed to light the way through foggy, rainy, dusty, or snowy conditions, these fog beams feature large 6.5" (16.5 cm) diameter lenses and broad 70-degree beam spread. The hardened clear glass lenses have a dichroic coating for a low-glare yellow light. Features include 55W H3 halogen bulbs, vaporized aluminum over steel reflectors for great light output, thin-profile powder-coated steel cases for excellent water resistance, and a wireless control switch for hassle-free installation.

Kit contains two lights, mounting hardware, wireless control, transmitter, wiring, rock guards, and covers.



Jeep® JK Fog Light Replacement Kit

Our Jeep® JK fog light replacement kit allows you to mount our D-Series (Dually or D2) LED lights in your JK's OEM fog lamp locations. This kit gives your otherwise square D-Series lights a clean from-the-factory look without having to drill or cut into your bumper. Made from high quality stainless steel, these adaptor plates are powder-coated black for a long-lasting finish. This kit comes with everything you need to install D-Series lights in both fog light locations and is backed by a limited lifetime warranty.

Part No. 40138 - 07-14 Wrangler



KC HiLITES



Gravity Series LED

- Gravity LEDs combine projected LED lighting with precision reflector optics for increased distance vision
- IP68 rated
- Driving and fog beam models are SAE/ECE street legal
- 6" Gravity LED Inserts convert halogen KC Daylighters® into LED lights

Part No.	Description	Beam Type	Watts
493	4" Gravity LED Fog - Universal Mount	Fog	10
494	4" Gravity LED Fog - JK Replacement	Fog	10
643	6" Pro-Sport LED	Spot	20
644	6" Pro-Sport LED	Driving	20
711	4" x 6" Gravity LED Driving	Driving	20
42134	6" Gravity LED Insert	Spot	20
42054	6" Gravity LED Insert	Driving	20



NEW

FLEXLED

Flex LED Systems

FLEX LEDs are a modular and customizable performance off-road LED lighting platform, that can be expanded as needs change. The FLEX Single is a compact and powerful stand-alone LED light. FLEX Duals and Arrays can be used as stand-alone lights, with the Duals and Arrays having the ability to be linked and stacked to each other to create a custom led light bar systems. Colored bezels sold separately



Part No. 270



Part No. 271

Part No.	Description
270	FLEX Single Pair Pack
271	FLEX Dual Spot Beam
272	Flex Dual Spread Beam
30551	Black Bezel Kit; Pair

Part No.	Description
30552	Gold Bezel Kit; Pair
30553	Blue Bezel Kit; Pair
30554	Red Bezel Kit; Pair

PIAA

RF Series Hybrid SAE Compliant LED

The RF Series Hybrid meets SAE and E-Code specifications for beam pattern control and output so you can drive without worry of failing an inspection. This makes for an easy transition from off-road driving to street legal use. The hybrid beam pattern is the ideal combination between a driving and fog pattern, providing the perfect distance and width to light up off-road terrain.



- Cast aluminum housing
- Reflector Facing Technology uses Rear-facing LEDs for maximum output and precision
- Modular design allows connecting bars to achieve a desired length

Part No.	Description
2607106	6" RF Series Hybrid
2607110	10" RF Series Hybrid
2607118	18" RF Series Hybrid

540 Series 5" Diameter

- Bulb Type 12V- H3 55w=85w XTRA Fog, and 12V-H3 55w=110w XTRA Xtreme White for driving, SAE compliant
- Black stamped steel housing, glass lens, and mesh style covers
- Kit comes complete with pre-assembled wiring harnesses



Part No. 05461 - Plasma Ion Fog
Part No. 05462 - Xtreme White Driving

RF Series 3" LED Cube Light Kits

The PIAA RF3 3" LED Cube light features Reflector-facing LEDs that project off of an ingenious computer-designed multi-surface reflector offering more illumination than forward facing LED Lights. The RF3 kit includes two lights, mounting brackets, and complete wiring harness and detailed installation instructions.



- Two 8-watt LED bulbs
- 6000K Color temperature for a pure white output
- Low profile, cast aluminum housing
- High strength polycarbonate lens

Part No.	Description
07603	Driving Beam (SAE Compliant)
07340	Flood Beam

Custom Fit Lamp Kits

- These kits allow the simple installation of our premium lamps for replacement or addition of our performance driving lamps
- Kits include driving lamps, complete harness with switch and fuse, hardware and instructions.



Part No.	Application
05330	07-15 Wrangler Bumper Factory Fog Replacement (SAE)
05312	07-15 Wrangler Windshield Mount and LP530 LED Driving Kit
05512	07-15 Wrangler Windshield Mount and LP550LED Driving Kit

Rugged HI Intensity 3W LED

- Lifetime Warranty
- Color: White

Part No. 881026 - 12"
Part No. 881032 - 20"
Part No. 881028 - 24"



Part No. 881029
Rugged 38" Off-Road
Hi-Intensity LED

Rugged Vision Lights

With the newest Hi-Intensity LED technology on the market, these lights make night seem like day.



Part No. 881004
Rugged 6"
Off-Road
Hi-Intensity LED



Part No. 881003
Rugged 4" Off-Road
Hi-Intensity LED

Part No. 881005
Rugged 10"
Off-Road
Hi-Intensity LED

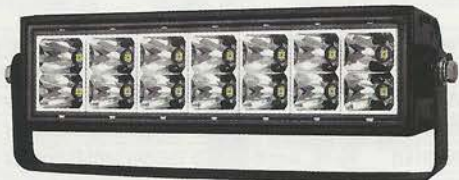

PILOTTM

AUTOMOTIVE



- Part No. PL360C
- Die-cast aluminum housing
 - 55 watt halogen / PLH3K bulb
 - Pre-assembled wiring harness with a relay
 - Available in blue lens with yellow beam (PL360B)
 - Available in blue lens with simulated HID white beam in Navigator packaging (NV360W)
 - Micro mouse switch with LED (PLSW9B)

LuminixTM

High Power LED Bars



Straight Luminix LED Light Bars

Part No.	Straight Luminix LED Light Bars	Wattage	
		Per Bar	AMP Draw
10004	3.5" x 4.5" Block	18	1.5A
10006	6" 1800 lm	9	.75A
10010	10" 2,700 lm	27	2.25A
10020	20" 5,400 lm	54	4.5A
10030	30" 8,100 lm	81	6.75A
10040	40" 10,800 lm	108	9A
10050	50" 13,500 lm	135	11.25A
10060	60" 16,200 lm	162	13.5A
10070	70" 18,900 lm	189	15.75A

All Luminix LED Light Bars include one wiring harness, one rocker switch, and two sets of installation brackets in tall and short.



Curved Luminix LED Light Bars - 6 Degree Radius

- High Power Luminix LED Light Bars deliver high quality, universal bright lighting that is 300% smaller than other light bars on the market
- Constructed of black powder-coated 6061 billet aluminum, feature Nichia 5.4W LEDs, and focus lenses that concentrate the light beam path
- Each bar comes fully assembled and ready to mount
- The miniaturized size of this bar makes it ideal for installation in narrow openings
- The bars are available in 5" - 70" lengths and include a wiring harness and standard mounting hardware

Part No.	Curved Luminix LED Light Bars	Wattage	
		Per Bar	AMP Draw
10033	30", 100 lm	81	6.75A
10046	40", 11,200 lm	112	11A
10055	50", 14,200 lm	145	12A
10063	60", 16,800 lm	168	15A

Cree XM-L2

- Solid aluminum design with built in micro-fan
- 200 Lumens per wattage
- Plug-n-Play installation on most vehicles
- Each kit is bulb type specific to plug into existing factory wires and housing
- Stable operating design
- IP65 - shock proof
- Constant current CPU
- Internal overheating protection
- EMC anti-interference design
- Waterproof driver



Part No.	Application
260001W	H16
260003W	H3
260004W	H4
260007W	H7
260008W	H8
260009W	H9
260010W	H10
260011W	H11
260013W	P13W
2600H1W	H1

Part No.	Application
260880W	880/893
260881W	881/886
260H13W	H13
269004W	9004
269005W	9005
269006W	9006
269007W	9007
26PSX24	PSX24W
26PSX26	PSX26W



LED Taillights

- Uses less power and emits almost no heat
- Resistant to vibration and shock better for off-road
- Offers superior brightness
- All DOT compliant to FMVSS-108
- OEM style weather tight connections and wire harnesses
- Chrome plate reflector for maximum lumination and crystal clear lens
- Simple plug and play installation



Part No.	Application
311203	07-16 Wrangler - Smoke
311201	07-16 Wrangler - Chrome
311212	07-16 Wrangler - Black
861082	76-06 Wrangler



LED Taillight Assembly

Made with impact and UV resistant Polycarbonate lenses that are sonically sealed to prevent moisture issues. Typically, standard incandescent light bulbs might last only 1,000 to 2,000 hours. KC long-life LEDs last in excess of 100,000 hours with increased visibility and safety.

Part No.	Application
1001	Jeep® and Trailer Kit with Backup Lights
1002	4" Round - Red Lens - Single
1004	4" Round - Clear Lens - Single
1008	5" Rectangular - Red Lens - Single
1000	Trailer Taillight Kit - Red Lens - Set of 2
1013	6" Oval - Red Lens - Single



Crystal Eyes Taillights

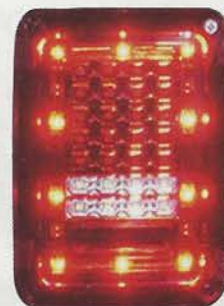

- In the next few years all high end cars will have LED taillights and IPCW offers you the ability to upgrade that technology into your vehicle
- LEDs give you increased light output, react faster and are more durable than any conventional type light
- When it comes to look and function, these taillights designed to set your ride apart from the crowd
- LEDs are well engineered complete kits that combine simple Plug and Play installation and SAE/DOT compliance

Part No.	Application
LEDT420CB	07-16 Wrangler - Bermuda Black
LEDT420CR	07-16 Wrangler - Ruby Red
LEDT420CS	07-16 Wrangler - Platinum Smoke
LEDT420C	07-16 Wrangler - Crystal Clear
LEDT407CB	87-06 Wrangler - Bermuda Black



Jeep® LED Tail Lamps

- Brighter and safer light output
- Restyles your vehicle
- Solid state technology for heavy-duty use
- 100,000 hours of long life LED technology
- Easy plug-in installation to factory wiring harness



Part No.	Application
NV001	87-06 Jeep® LED Taillight without Connector (Passenger Side)
NV001L	87-06 Jeep® LED Taillight without Connector (Driver Side)
NV001Q	98-06 Jeep® TJ LED Taillight with Connector (Passenger Side)
NV001LQ	98-06 Jeep® TJ LED Taillight with Connector (Driver Side)
NV001LFO	91-97 Jeep® YJ/TJ LED Taillight with Connector (Driver Side)
NV002R	07-15 Jeep® JK LED Tail Lamp (Passenger Side)
NV002L	07-15 Jeep® JK LED Tail Lamp (Driver Side)





KC HiLITES Jeep® LED Pair Pack

DOT-approved LED headlights that are plug-and-play, designed to significantly increase your stock headlight lighting output for your JK. These LED headlights produce a smooth beam pattern, have high and low beams, mount to the stock locations, and come with the necessary hardware to complete the installation quickly.

Part No. 42321 - 7-16 Wrangler

PILOT™
AUTOMOTIVE

LED Headlamps

- Innovative design and the latest Osram LED Technology
- Lifetime greater than 30,000 hours
- Low power consumption to save fuel and energy
- Shock and vibration resistant design
- H4 connector allows Plug and Play installation
- UV-resistant PC hard coated front lens
- Aluminum housing, standard 7" sealed beam mounting points

Part No. VPE3106 - Chrome
Part No. VPE3106B - Black



Crystal Eyes Conversion Headlights

- Sealed beam conversion headlights are an improvement over OE lights because our conversion kits give you the capability to retrofit modern, top of the line 9003/H4 bulbs to your vehicle
- Gives you the ability to replace just the burnt out bulb with the current generation of bulbs on the marketplace
- Lights are top of the line units which utilize glass instead of plastic in the lens for clearer light output and enhanced durability
- Some lights also have a secondary bulb that can be wired up as either a running light or as auxiliary turn signals



Part No.	Application
CWC7003	5 3/4" - Plain
CWC7004	4" x 6" - Plain
CWC7005	7" x 6" - Plain
CWC7006	7" - Plain
CWC7012	7" x 6" - Diamond Cut
CWC7012B	4" x 6" - Diamond Cut



Halogen Conversion Headlight Kit

- Advanced multi surface reflector and clear glass lens
- Produces 60% more luminous beam than conventional OEM sealed beam headlights
- Durable die cast aluminum reflector
- SAE/DOT approved for street legal use

Part No. 5089925 - 7" Round Halogen Conversion Kit - Pair
Part No. 5089927 - 200 mm Rectangle Halogen Conversion Kit - Pair



PUTCO™

Nite-Lux Nylon LED Kits

- 100% high temperature nylon construction
- Newest and most advanced LED Kit available in the world
- High Lumen output - 2500 lumens each
- IP68 - IP65 Shock Proof
- Lifespan greater than 50,000 hours
- Sold in pairs - single kits available by request

Part No.	Application
270004	H4
270008	H8
270011	H11
279005	9005
279006	9006
270010	H10

Part No.	Application
270P13	P13W
27PSX26	PSX26W
270016	H16
27PSX24	PSX24W
270007	H7



LED Headlight Kit With Halo

- Headlights meet each DOT requirement, meaning the light is safe to use on public roads
- Durable UV resistant polycarbonate lens
- IP-68 Rated
- Features a bright halo ring that can be active without having the low beam or high beams on

Part No. 9891224 - 7" Round - Chrome Plated



ANZO USA

H4 7" Round LED Headlights

- Headlights are computer designed for innovative trend setting style using the latest in C.A.D. technology and equipment
- Cold Cathode Fluorescent Lamp (CCFL) is a gas discharge lamp, the newest technology in performance lighting
- Features the newest halo design utilizing CCFL technology to insure high brightness, higher efficiency, lower power consumption and longer life
- Our precision application design and OEM style weather tight connections and wire harnesses ensure a weather-resistant fit in even the toughest climates

Part No. 881035 - Black with Anzo logo - Pair
Part No. 881036 - Chrome with Anzo logo - Pair





TruckLite LED Headlight Kits
Featuring Heated Lenses

NEW

Truck-Lite® Headlight Kits by Rigid Industries are an excellent option for light, medium and heavy-duty trucks, off-road vehicles, classic cars, motorcycles and more. Heated lenses provide complete surface melting of snow and ice, only active when temperatures drop under 50°F.

- Solid state design is impervious to vibration
- Metalized reflector optics provide a smooth beam pattern
- Round and rectangular options available



DOT Compliant

Part No.	Description
55004	7" Round Heated with PWM Adaptor
55000	7" Round with PWM Adaptor
55001	7" Round with H13 to H4 Adaptor
55005	7" Round Heated with H13 to H4 Adaptor
55002	7" Round Single
55003	5" x 7" Rectangular



Explorer Series LED Lights

- Tuned chrome reflectors engineered to project maximum amount of light
- 6063 extruded aluminum housing with integral heat sink provides durable structure and efficient cooling
- Shockproof, waterproof and UV-shielded to guard against the elements
- Durable anodized polyester powder coat finish provides protection in any environment
- Wiring harness with relay, quick connector and illuminated switch included with every light
- Compact low-mass design for easy installation

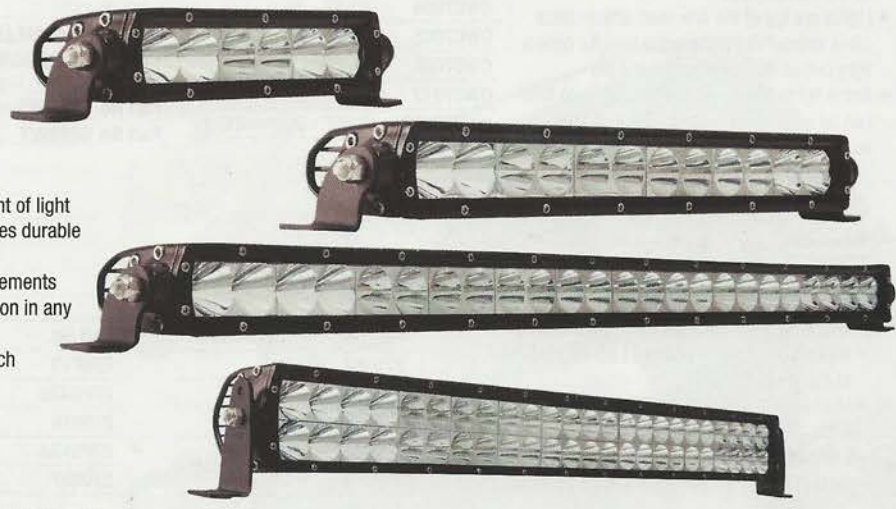

Explorer Series Single Row LED Lights

Part No.	Description	Length (inches)	Height (inches)	Width (inches)
76306	SR6 - 6 LED 7-5/8"	8	6	6
76310	SR12 - 12 LED 13-5/8"	12	6	6
76320	SR24 - 24 LED 25-5/8"	22	6	6
76340	SR36 - 36 LED 37-5/8"	42	6	6
76350	SR48 - 48 LED 49-5/8"	52	6	6



Explorer Series Double Row LED Lights

Part No.	Description	Length (inches)	Height (inches)	Width (inches)
76406	12 LED 7-3/4"	8	6	6
76410	24 LED 13-3/4"	12	6	6
76420	48 LED 25-3/4"	22	6	6
76440	72 LED 37-3/4"	42	6	6
76450	96 LED 49-3/4"	52	6	6





Radiance LED Kits
E-Series Quality With Colored Backlighting

Rigid Industries' Radiance is feature-packed, with a black exposed printed circuit board, optimized forward projecting optics and back-lighting available in white, green, blue and red. E-Series Construction and Durability

- 9-15 V DC
- High-grade aluminum alloy housing and heat sink
- Black powder coated brackets
- Black exposed printed circuit board
- Back-lighting available in white, green, red and blue
- Dedicated wire to run back-lighting without primary LEDs
- Complete multi-switch wiring harness available (sold separately)

	Red	Green	Blue	White
Length	Part No.	Part No.	Part No.	Part No.
10"	21002	21003	21001	21000
20"	22002	22003	22001	22000
30"	23002	23003	23001	23000
40"	24002	24003	24001	24000
50"	25002	25003	25001	25000



Part No. 12021BLK

Midnight Edition LED Kits
Available in D-Series, E-Series and RDS-Series

It's all about stealth with Rigid's new midnight optics which "disappear" during the day while still providing powerful LED technology to light up the night.

- Transparent black enamel on our patented hybrid spot optics
- All black assembly hardware
- Special black polymer coated circuit board
- Understated embossed Rigid Industries' name on bezel
- Available in RDS-Series, E-Series and D-Series lights

Part No.	Description
20221BLK	Dually Pair Pack
10621BLK	6" E-Series Hybrid Spot
12021BLK	20" E-Series Hybrid Spot
15021BLK	50" E-Series Hybrid Spot
88521BLK	50" RDS Series (Curved)



Part No. 20221BLK

*Many more models available

Rock Light Kit

Rigid Industries Rock Light Kit combines the high powered durable A-Series LED lighting with custom 15' Leads on each light, a distribution block, switch, and angled mounts to light up any truck, Jeep® or vehicle. The Rigid Industries Rock Light Kit will allow you to see and your vehicle to be seen no matter what trail you choose. Offered in 4 light or 6 light kits in cool white, red, blue, green or amber LED options to customize your night crawling experience.

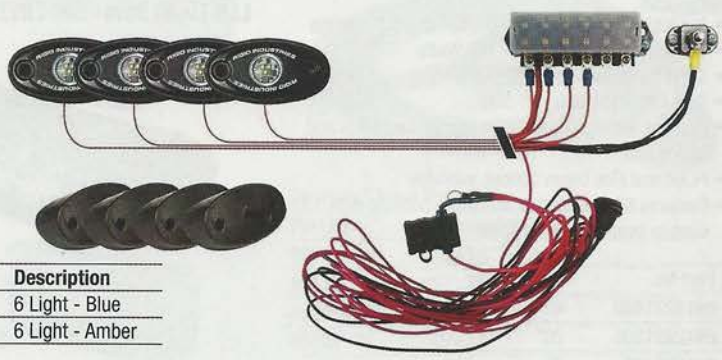

Part No.	Description	Part No.	Description	Part No.	Description
40020	4 Light - White	40024	4 Light - Amber	40028	6 Light - Blue
40021	4 Light - Red	40025	6 Light - White	40029	6 Light - Amber
40022	4 Light - Green	40026	6 Light - Red		
40023	4 Light - Blue	40027	6 Light - Green		



Part No.	Beam Pattern	Lumens (total output)	Length (inches)
1108131	Spot	2100lm	7.60
1108141	Flood	2100lm	7.60
1110131	Spot	3150lm	10.80
1110141	Flood	3150lm	10.80
1110151	Combo	3150lm	10.80
1120131	Spot	5250lm	20.00
1120141	Flood	5250lm	20.00
1120151	Combo	5250lm	20.00
1130151	Combo	8400lm	30.00
1140151	Combo	12600lm	40.00

5 Watt Single Row LED Light Bar

- Cree Chip technology
- CE and RoHS approved
- Die cast aluminum housing
- Rubber strip sealed cover
- 30,000 hours of working life
- Low power consumption
- Softer light to prevent glare
- Limited lifetime warranty



3 Watt Double Row LED Light Bar

Part No.	Beam Pattern	Lumens (total output)	Length (inches)
1306151	Combo	2880lm	6.00
1312151	Combo	5760lm	12.00
1320151	Combo	9600lm	20.00
1330151	Combo	14400lm	30.00
1340151	Combo	19200lm	40.00
1350151	Combo	23040lm	50.00

3 Watt Double Row Curved LED Light Bar

Part No.	Beam Pattern	Lumens (total output)	Length (inches)
1420151	Combo	9600lm	20.00
1430151	Combo	14400lm	30.00
1440151	Combo	19200lm	40.00
1450151	Combo	23040lm	50.00
1454151	Combo	24960lm	54.00

Double Row LED Light Bars



- Includes fully terminated wiring harness, relay and illuminated switch
- IP67 rated
- 3 Watt Cree LED chip technology
- Combination flood/spot beam
- 6000K color temperature
- Die cast aluminum housing
- 30,000 hours of working life

Part No.	Length (inches)	Number of LEDs	Lumens (total output)
1306151	6	12	2880lm
1312151	12	24	5760lm
1320151	20	40	9600lm
1330151	30	60	14400lm
1340151	40	80	19200lm
1350151	50	96	23040lm

Light Bar Cover Kits



- Kit part numbers include enough smaller covers to protect entire light bar
- Double and single row available
- Adds style and protection to your light bar
- Also sold as individual covers for all straight bars and cubes
- Talk to your salesperson for more applications
- TrailFX specific

Part No.	Description
13501K2	Amber 50" Double Row Kit
13501K3	Black 50" Double Row Kit
13501K4	Smoke 50" Double Row Kit
11401K2	Amber 40" Single Row Kit
11401K7	Smoke 40" Single Row Kit
11401K3	Black 40" Single Row Kit



Xtreme XP Low Profile Single Row LED Light Bars - 5W CREE

- Available in 6", 10", 20", 30", 40" and 50" lengths
- Wattage range: 30 Watts - 250 Watts
- GORE® pressure equalizing vent
- Raw lumens: 3,000 - 21,500
- Includes wiring harness with connector, switch and in-line fuse
- Flood and Flex beam options available
- Features 6063 extruded aluminum housing with custom over-sized heat sinks

Part No.	Description
091223140S	40"
091223120S	20"
09122316S	6"
091223110S	10"



C-Series LED Lights and Light Bars

- 12-watt 4-LED light rated at 1,080 lumens
- Compact 3" IP67 rated die-cast aluminum housing
- Available in spot or flood beam patterns
- On-board thermal management
- Protected against RFI/EMC interference
- 50,000 hour LED life
- Pair pack systems include 2 lights and complete wiring kit

Part No.	Description
330	C3 Spot LED Clear Light System
332	C3F Flood LED Clear Light System
315	C3 Spot LED Amber Light System



C-Series LED Light Bars



- 10", 20", 30", 40" and 50" models with a wiring harness included
- IP67 rated extruded aluminum housings with die-cast aluminum mounting brackets
- Combo Spot/Spread beam patterns with 50,000 hour LED life
- On-board thermal management

Part No.	Application
334	C10, 10", Clear, 20 LED, 60 watt - 5,400 lumens
335	C20, 20", Clear, 40 LED, 120 watt - 10,800 lumens
336	C30, 30", Clear, 60 LED, 180 watt - 16,200 lumens
337	C40, 40", Clear, 80 LED, 240 watt - 21,600 lumens
338	C50, 50", Clear, 100 LED, 300 watt - 27,000 lumens
316	C10, 10", Amber, 20 LED, 60 watt - 5,400 lumens
317	C20, 20", Amber, 40 LED, 120 watt - 10,800 lumens

Cyclone LED Under Hood Light Kit

- For added under hood illumination
- Compact 2.2" diameter and flat profile
- IP68 rated dust and waterproof
- Easily attaches anywhere with a Dzus clip or other readily available fasteners
- Protected against RFI/EMC interference
- Includes wiring harness, weatherproof switch and mounting hardware



Part No. 351

Gravity 4" LED Replacement JK Fog Lights

- SAE/ECE certified street legal
- IP68 rated & protected against EMI interference
- 6,500K color temperature

Part No. 494 - Pair



4X4 ACCESSORIES

Intensity LED Lights

- High pressure cast A360 aluminum body, integrated thermal management
- Unbreakable polycarbonate lens, protected against RFI/EMC interference
- UV stable moulded polycarbonate lens cover
- Multiple position stainless steel mount
- Durable UV stable polyester powder-coat
- The pressure cast aluminum housing acts as a heat sink to draw heat generated from the electronics away from the LED array, thus increasing efficiency and life of the LED
- Has a cap screw pivot bolt with tamper proof TORX® security fasteners used on the adjuster nut for improved security

Part No. AR32F - Driving/Fog Light - Flood Beam

Part No. AR32S - Driving/Fog Light - Spot Beam

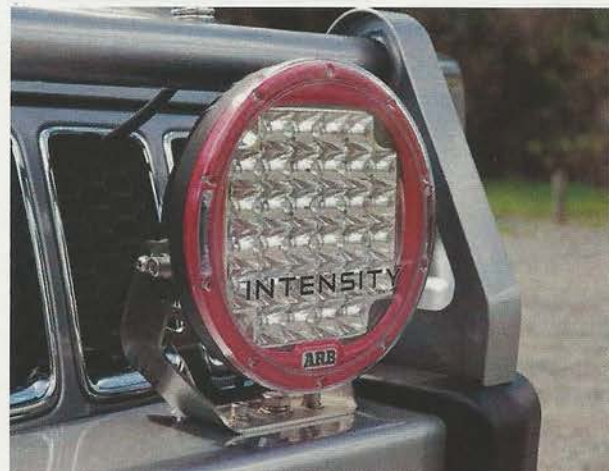



Windshield Mount and LED Light Bar Combo For 15-16 Renegade

Daystar's KJ81000BK LED light bar and mounting bracket system is specifically designed and engineered to fit all models of the new Jeep™ Renegade. This System includes our unique 40" KC LED light bar and Mounting System.

- Black powder coat finish
 - Mounts to factory roof rack
 - No drilling required
 - Combo beam spot and spread LED reflectors
 - Comes complete with wiring harness
 - Go everywhere limited lifetime warranty
- Part No. KJ81000BK**



Windshield Light Bar Mount

AnzoUSA™ introduces a new line of tubular mounting clamps to compliment our new off road lights. Our mounting kits provide a stable mounting point for AnzoUSA™ universal/off-road lighting products on most brush guards, bull bars and push bars with rounded tubing. Our tubular clamps are made of 6063 Aluminum with a black anodized finish that is corrosion proof and will withstand the harshest of environments.

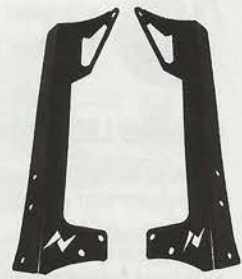

Part No. 851033 - 07-15 Wrangler



Luminix Roof Mount

Adding Putco Luminix Custom LED Light Mounting Brackets are a great way to get a vehicle specific installation for your Luminix LED Light Bar. The stainless steel mounting hardware along with the adjustable brackets allow for a clean installation to the roof or bumper of your specified vehicle. Once on your ride the light will provide optimal seeing power. Using the Putco Luminix Custom Light Mounting Brackets will sustain through anything. Made from durable quality materials each bracket will hold up to daily wear and tear. Don't let this product pass you by, optimize your Luminix lightbar.



Part No. 2180 - 07-15 Wrangler JK



Light Bar



- Rugged, fully welded design for extra strength
 - Textured black powder coated finish
 - Facilitates mounting of light above the windshield
 - Easy assembly and installation
 - Four light mounting tabs
- Part No. J017T - 07-15 Wrangler JK**



Hood Mount Kit

If you ever wanted to place a light bar directly on your Jeep®'s hood, without punching through the hood itself. Now you can. Our one of a kind hood bracket let's you secure a 10 or 20 Inch light bar directly on your hood. The bracket, made of powder coated stainless steel attaches securely to the hinges on your Jeep®'s hood. Installation is simple and easy. Comes with a limited lifetime warranty.



Part No. 40332 - 07-15 Wrangler JK
Part No. 40333 - 07-15 Wrangler JK



A-Pillar Mounts

- No drilling necessary
- Perfect for Optimus or Cannon series
- Add up to 5,000 lumens

Part No. 9888408 - 07-15 Wrangler JK
Part No. 9888415 - 07-15 Wrangler JK



Black Light Hood Bracket

- Engineered to high standards
- Finished in a black powder coat
- Comes complete with all necessary hardware
- Easy to install, no drilling
- Tested under extreme conditions



Part No. 7690 - 07-15 Wrangler



X-Clamp

The X-Clamp from Rugged Ridge features "Pivotal Fit Technology," an innovative and unique adjustment which allows perfect fit mounting to tubes ranging from 2.25" to 3". No gaps, no gaskets! Rotate the X-Clamp to fit your tube, pivot the mounting bracket to the desired position, and then apply the logo to the front.



Part No. 1103002 - Black, Pair
Part No. 1103011 - Silver, Pair

DELTA LIGHTS



Part No. 019570ABX 57" SKY-BAR™



Proudly Made in the USA



Halo Off-Road Lights

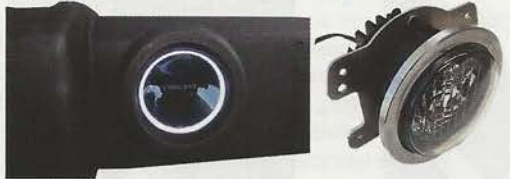

Halo Bumper Fog Lights



Part No. 011198LEDH

Halo Jeep® Headlights

Jeep® JK Wrangler Specific Mounts

Hood Mounts

Supplier	Part No.	Supplier
R2G	40332	Rigid (Mounts 10" Bar)
R2G	40333	Rigid (Mounts 20" Bar)
K13	367	KC HiLITES (Mounts 30")
K13	2285	Putco (20" LuminiX Only)
K13	182736	MBRP (Mounts 20" Bar)
K13	367	KC HiLITES (Includes 30" Bar)
K13	7409	KC HiLITES (Tubular w. Tabs)
W16	0941015	Westin (Mounts 20" Bar)
W16	0941025	Westin (Mounts 40" Bar)

Windshield (Brow) Mounts

Supplier	Part No.	Supplier
R2G	40131	Rigid
N21	J0750LR	N-Fab (Mounts One 50")
N21	J07350LR	N-Fab (Mounts Two 50")
N21	J07150LR	Mounts One Rigid SR-Series
B99	LED3288BRK	Black Mountain
A1R	851033	Anzo
M79	182746	MBRP/ Off Camber Fabrications
P1Z	510451	Paramount
P45	2180	Putco (LuminiX Only)

A-Pillar Mounts

Supplier	Part No.	Supplier
R2G	40331	Rigid (Mounts One D-Series)
R2G	40335	Rigid (Mounts Two D-Series)
O31	1102703	Rugged Ridge
S53	7690	Smittybilt
K13	7316	KC HiLites
V45	9888408	Vision X (Includes 20W Optimus)
V45	9888415	Vision X (Includes 25W Cannon)
P27	05410	PIAA (Includes 540 Series Halogens)
P27	30110	PIAA (Bracket Only)
P45	2280	Putco
M79	130719	MBRP/ Off Camber Fabrications

Bumper Mounts

Supplier	Part No.	Supplier
W16	0941055	Westin (For Pedestal Lights)
W16	0941065	Westin (Mounts 30" Bar)
M79	130716	MBRP (Tab Style)
M79	136250	Adapter For LED Bar
K13	368	KKC HiLITES (Includes 20" Bar)



Bestop
Fit. Function. Style.



Trektop™ Pro

Industry First: All-Season Soft Top with Glass Windows

- Industry-first hard rear glass hatch on a soft top for easy, one hand operation and easy accessibility to rear cargo area
- Premium 30-oz. triple-layer black acrylic twill fabric for durability and great, no-wrinkles appearance
- Bestop's Sunrider® flip-back panel for open air driving
- Weighs up to 50 lbs. less than a hard top, can help save gas
- Sliding glass side windows for extra ventilation for front & rear seat passengers or pets
- Easy install or removal of rear hatch and side window panels
- Rear glass hatch has gas assist struts and integrated defroster connector plus rear wiper motor assembly mounting point
- Rear hatch is removable unlike factory or aftermarket hard tops
- With side panels and rear glass removed, Trektop™ Pro becomes a Safari Bikini®

Part No.	Application
5485317	07-16 Trektop™ Pro for Wrangler Unlimited
5485217	07-16 Trektop™ Pro for Wrangler (Two Door)
5485701	Optional Defroster/Wiper Harness
5485801	Optional Wiper Motor Assembly



Window Storage Portfolio Bag

- Holds Trektop™ Pro rear glass hatch and both side window panels
- Designed to hang from seat headrests when removing on the go

Part No. 4281101



Trektop™ Pro window panels install or remove quickly without zippers. Top Rails have custom-sized channel that let windows slide into or out of the channels. Bottom of window panels attach to the Belt-Rail® channel in the body for a complete seal.



Trektop™ Pro has modular Top Rails that join door surrounds to the Arch Body for a solid, secure structure. Simple, bolt-on install without drilling or punching holes.



Trektop™ Pro has an integrated defroster connector that hooks up to your factory wiring bundle on hardtop Wranglers. Bestop also offers an optional harness for Wranglers that didn't have a hardtop, plus an optional Wiper Motor Assembly.



Trektop™ Pro has real glass that works just like a factory hardtop. No more unzipping the rear window, no more tailgate bar to remove. Just open the tailgate and the gas-assist struts lift the hatch with just the pull of one hand.



Bestop's Belt-Rail® channel design means no more unzipping windows. Window panels slip into extrusion channels in the Arch Module for a complete seal at the rear glass.



Trektop™ NX Fastback Styling

Best Seller!

Bestop's "bowless" fastback top. The Trektop NX features removable windows, factory style-door surrounds, Sunrider sunroof features, and factory-style header bar. The Trektop NX takes away the top bows and frames, and uses the Wrangler sport bars to give it shape and support. This gives the top a look that's stylish, and different than factory soft tops.

- With side and rear windows removed, the Trektop NX functions as a Safari Bikini® Top
- Includes fabric, tinted side and rear windows, factory-style door surrounds, tailgate bar
- Fabric maintains its shape in all temperatures, is mildew-resistant, contains UV inhibitors
- Tailgate bar allows you to open tailgate without opening the rear window
- Top Arch bar spans above the seating area to keep top tight, reduce flapping, and minimize puddling
- Choose the optional door style you want; use your existing full steel doors, or use any Bestop door kit (sold separately) including 2-piece doors, upper fabric doors, element doors or lower fabric half doors
- Two year warranty



Trektop™ NX Black Twill

All the features of the NX, but with these upgrades:

- 30 oz. triple-layer black twill fabric for superior durability
- Wrinkle resistance creates smooth appearance and softer feel in all weather
- 40 Mil. DOT approved tinted rear and side windows

Part No.	Black Twill Part No.	Application
5682235	5692217	07-16 JK
5682335	5692317	07-16 JK Unlimited
5682135	—	04-06 TJ Unlimied
5682035*	5692017	97-06 TJ

*Change last two digits for Black Denim(15) and Spice (37)



Blk Denim	Black Dia	Spice
15	35	37

Supertop™ NX

Bestop's factory style soft top comes with factory-style door surrounds, factory-style windshield channel, and tinted windows. Plus, it includes a Top Arch to support the fabric, quick release bow knuckles for tool-less top removal, and a new adjustable plate to keep top taught.

- Complete top with OEM style hardware
- Fold back sunroof feature
- Multiple door kits available
- Two year warranty



Black Twill Supertop™ NX

Same Features as the Supertop NX but with the following upgrades:

- 30 oz. triple-layer Black Twill Fabric for superior durability and looks
- Greater softness and flexibility in all temperatures
- 40 mil. D.O.T. approved 31% tinted side and rear vinyl windows
- Lifetime limited warranty

Black Twill Supertop NX Part No.	Supertop NX Part No.	Application	Colors
5482217	54722	07-16 Wrangler	35,36
5482317	54723	07-16 Wrangler Unlimited	35
—	54721	04-06 TJ Unlimited	35
5482017	54720	97-06 TJ Wrangler	15,35,37

Blk Denim	Black Dia	Khaki Dia	Spice
15	35	36	37



BESTOP

Fit. Function. Style.

Replacement Tops for Your Jeep®

Replace-A-Top Black Twill

Already have a factory original soft top but want the high-end look, feel and durability of our Black Twill? Then look no further.

- Built to factory original specifications (requires original hardware)
- 30 oz. triple-layer Black Twill Fabric for superior durability and looks
- Greater softness and flexibility in all temperatures
- 40 mil. D.O.T. approved 31% tinted side and rear vinyl windows
- Lifetime limited warranty

Part No.	Application
7984717	10-16 JK Unlimited
7984617	10-16 JK 2 Door
7983717	07-09 JK Unlimited
7983617	07-09 JK 2 Door
7984117	97-06 TJ

When ordering, add color code to the end of the part number.

Black	Blk Denim	Black Dia	Khaki Dia	Spice
01	15	35	36	37

Replace-A-Top™

- Takes advantage of your still good factory hardware, and gets you all new fabric, windows and door skins, where applicable
- Require factory original hardware and built to factory specifications for proper fit
- Kits with replacement doors skins attach over factory original door frames
- Two-year limited warranty

Part No.	Application	Colors Available
51128	03-06 Wrangler (Includes half door skins)	35
51178	03-06 Wrangler (Half door skins not included)	35
51193	03-06 Wrangler with tinted windows (Half Door skins not included)	35
51129	03-06 Wrangler with tinted windows (Includes tinted side and rear windows & un-tinted half door skins)	35
51121	97-02 Wrangler (Includes half door skins)	15 37
51124	97-02 Wrangler with tinted windows (top features tinted side and rear windows and un-tinted half door skins)	15 33 37
51180	97-02 Wrangler with tinted windows (Half Door skins not included)	15 33 37
51127	97-02 Wrangler (Half door skins not included)	15 37



Sailcloth Replace-A-Top™

- The tough, premium fabric dramatically reduces outside noise and enhances insulation
- Heat-sealed vinyl windows meet U.S. and Europe regulations
- Built to factory original quality specifications to ensure a proper fit
- Kits with door skins attach by Velcro® over factory original door frames for easy installation
- Optional 31% tinted window feature for a customized look

Part No.	Application	Colors Available
79147	11-16 Wrangler Unlimited with tinted windows; half door skins not included	35
79146	11-16 Wrangler with tinted windows; half door skins not included	35
79143	2010 Wrangler Unlimited with tinted windows; half door skins not included	35
79142	2010 Wrangler with tinted windows; half door skins not included	35
79137	07-09 Wrangler Unlimited with tinted windows; half door skins not included	35 36
79136	07-09 Wrangler with tinted windows; half door skins not included	35
79141	03-06 Wrangler with tinted windows; half door skins not included	35
79140	04-06 Wrangler Unlimited with tinted windows; half door skins not included	35
79129	03-06 Wrangler with tinted windows, includes untinted half door skins	35 36
79125	03-06 Wrangler; half door skins not included	35
79124	97-02 Wrangler with tinted windows, includes untinted half door skins	01 37
79139	97-02 Wrangler with tinted windows; half door skins not included	01 37

Many More Tops and Bikinis Available



Bestop

Fit. Function. Style.

Bikini® Tops

- Bikini® top available in a wide variety of fabrics and colors for a huge range of vehicles and model years
- All Bikini® tops are made with premium fabric and industrial-grade thread and fasteners
- They will last longer maintain their shape and fit better than others
- Available colors vary per application
- Header Bikini® uses a special no-drill windshield channel for 97 and Up Wranglers

Sun Bikini®

An interior sun shade that attaches above the driver and passenger seats, and stays there whether your soft or hard top is on the vehicle.

- No windshield channel needed
- Targa-style covers front seats only
- Safari style length covers back to rear cargo area
- Choose Mesh fabric for filtered sunlight, or solid black diamond vinyl that blocks the sun and water

Part No.	Application
52401	07-16 JK Unlimited ; Safari Style
52402	07-16 JK 2 Door; Safari Style
52400	07-16 JK 2/4 Door; Targa Style
52404	97-06 TJ; Safari Style
52403	97-06 TJ; Targa Style

**Add 11 for Mesh, 35 for Black Diamond*



Header Safari Bikini

Part No.	Application	Colors Available
52532	03-06 Wrangler (Requires Installation Of #5123801)	11 15 36
52544	04-06 Wrangler Unlimited (Requires Installation Of #5123801)	35
52585	07-09 Wrangler (Requires Installation Of #5124301)	35
52581	07-09 Wrangler Unlimited (Requires Installation Of #5124301)	11 35
52583	10-16 Wrangler (Requires Installation Of #5124301)	35
52584	10-16 Wrangler Unlimited (Requires Installation Of #5124301)	35
52593	10-16 Cable-Style Wrangler 2 Door (Includes Windshield Channel Assembly; Requires Cable Style Soft Top Door Surrounds)	11 35
52594	10-16 Cable-Style Wrangler 4 Door (Includes Windshield Channel Assembly; Requires Cable Style Soft Top Door Surrounds)	11 35

When Ordering, add Color Code to The End of The Part Number. Example: 5253015

Black	Blk Denim	Black Dia	Khaki Dia	Spice
01	15	35	36	37



Header Bikini®

Part No.	Application	Colors Available
52525	97-02 Wrangler (Requires Installation Of #5123801)	11 15 37
52528	03-06 Wrangler And Wrangler Unlimited (Requires Installation Of #5123801)	11 35
52580	07-09 Wrangler (Requires Installation Of #5124301)	11 35
52586	10-16 Wrangler (Requires Installation Of #5124301)	11 35

When Ordering, Add Color Code to the End of The Part Number. Example: 5252835



Strapless Bikini®

Attach directly to the sport bar for a cleaner look.

Part No.	Application	Colors Available
52519	92-95 Wrangler (Requires Installation Of Windshield Channel 5120901)	09 15 37
52521	97-02 Wrangler (Requires Installation Of Windshield Channel 5121001)	15 37

When Ordering, Add Color Code to the End of The Part Number. Example: 5251801





Bestop
Fit. Function. Style.

Fabric Half Doors

Part No.	Application
5304035	07-16 JK and JK Unlimited Front Half Doors
5304135	07-16 JK Unlimited Rear Half Doors
5303935	97-06 TJ and TJ Unlimited Front Doors



Windjammer® and Duster®

Windjammer® from Bestop helps divert wind, rain and dust from entering the cab and keeps heat in the cockpit in cold weather. Duster® deck covers protect the rear of the Jeep® from dust and the elements. Combine a Windjammer and Duster with a Bikini® for a stylish look and outstanding protection.

Windjammer Part No.	Application	Color
80039	07-16 JK Unlimited*	35
80031	07-16 JK 2 Door	35
80032	03-06 TJ and TJ Unlimited	35,36
80030	97-02 TJ	15,37

*Requires Duster 9003135 and Extension 9003435 to Install

Duster Part No.	Application	Color
9003135	07-16 JK Unlimited	Black Diamond Only
9003335	07-16 JK 2 Door	Black Diamond Only
9002435	04-06 TJ Unlimited	Black Diamond Only
9002235	03-06 TJ	Black Diamond Only
90020	97-02	15,37

Duster Extension Part No.	Application
9003435	07-16 JK Unlimited

Blk Denim	Black Dia	Khaki Dia	Spice
15	35	36	37

Two Piece Fabric Doors

Bestop offers the most complete variety of door configurations on the market for your Jeep® soft top needs.

Part No.	Application
5179835	07-16 JK and JK Unlimited Front Doors
5179935	07-16 JK Unlimited Rear Doors
5178935*	97-06 TJ and TJ Unlimited Front Doors

Part numbers shown are Black Diamond Fabric
*Change last two digits for Black Denim (15) or Spice(37)



Windshield Channels

To attach a Bikini® to your Jeep®, you need a Windshield Channel. The information here will assist in purchasing the correct one.

Part No.	Application
5124301	07-16 JK 2/4 Door; No Drill
5123901	97-06 TJ and Unlimited; Two Piece
5123801	97-06 TJ and Unlimited



Sprint Top

- The Sprint Top has the same premium fabric and bowless fastback design as the Bestop Trektop™
- However, with the Sprint Top you take advantage of your door surrounds and windshield channel and save money
- Converts to Safari style Bikini top
- Factory soft top replacement, or else requires surrounds and window opening
- Flip back sunroof for super quick open air driving
- Doors not included: available separately
- Three-year warranty

Part No.	Application	Colors Available
56840	97-06 Wrangler (exc. TJD)	15, 35, 37
56842	10-16 Wrangler 2-door	35
56843	10-16 Wrangler Unlimited	35
56844	07-09 Wrangler 2-door	35
56845	07-09 Wrangler Unlimited	35

Blk Denim	Black Dia
15	35
Spice	
37	



Flip Top

- Full soft top (includes hardware and frame) with a fold back sunroof
- Removable windows
- One year warranty

Part No.	Application
4452715	97-06 Wrangler (No Doors)
4458715	97-06 Wrangler (Includes Upper Half Doors)

Available in Black Denim with Clear windows only.

KoolBreez™ Sun Screen Top

Summer would not be the same without the KoolBreez™ Sun Screen Top. This new high tech mesh material allows cool breezes to flow through while keeping the sun's heat and UV Rays out. KoolBreez™ will not flap or balloon in the breeze. Just sit back and enjoy the ride.

Part No.	Brief Top (Front Seats Only)	Windshield	Application
		Channel Part No.	
50715	Black Mesh	50901005	10-16 JK 4 Door
50711	Black Mesh	50901005	10-16 JK 2 Door
50710	Black Mesh	50901005	07-09 JK 2 Door
9702JKB*	Black Mesh	50901004	03-06 TJ Unlimited
9702JKB*	Black Mesh	50901003	97-02 TJ

Part No.	Full Top (Front and Rear)	Windshield	Application
		Channel Part No.	
50713F	Black Mesh	50901005	10-16 JK 2 Door
9702FJKB*	Black Mesh	50901003	97-02 TJ

*97-06 Also available in American Flag (add "1" to part number), Pirate Flag (2), or Confederate Flag (3)



Brief



Full



Extended Top

- Protection from the elements for front and rear passengers
- Constructed of same durable materials as our Standard Top
- Windshield Channel required for installation
- Attaches to rear with J-Clips and buckles

Part No.	Application
92911	92-95 Wrangler, Denim Gray
92915	92-95 Wrangler, Denim Black
92917	92-95 Wrangler, Denim Spice
93615	97-06 Wrangler, Denim Black
93617	97-06 Wrangler, Denim Spice
93635	97-06 Wrangler, Diamond Black
93636	97-06 Wrangler, Diamond Khaki
94135	07-09 Wrangler 2Dr, Diamond Black
94136	07-09 Wrangler 2Dr, Diamond Khaki
94535	07-09 Wrangler 4Dr, Unlimited Diamond Black
94536	07-09 Wrangler 4Dr, Unlimited Diamond Khaki



Outback Wind Breaker

- Crafted from the most durable components and designed for a hassle-free installation
- Deflects air-up and over the passenger area and reduces draft, noise, and moisture
- Features clear plastic windows for great rear visibility
- Attaches to roll bar, lower cutout is secured with zipper
- Fits: 55-84 CJ5/CJ6; 76-86 CJ7/CJ8; 87-10 Wrangler; and 04-12 Wrangler Unlimited

Part No.	Description	Part No.	Description
90011	Denim Gray	90035	Diamond Black
90015	Denim Black	90036	Diamond Khaki
90017	Denim Spice		

Windshield Channel



Part No.	Application
90101	76-95 CJ7/CJ8/Wrangler (Drilling Required)
90104	97-06 Wrangler/04-06 Wrangler Unlimited (No Drilling Required)
90105	07-14 Wrangler/Wrangler Unlimited (No Drilling Required)

Rugged Ridge

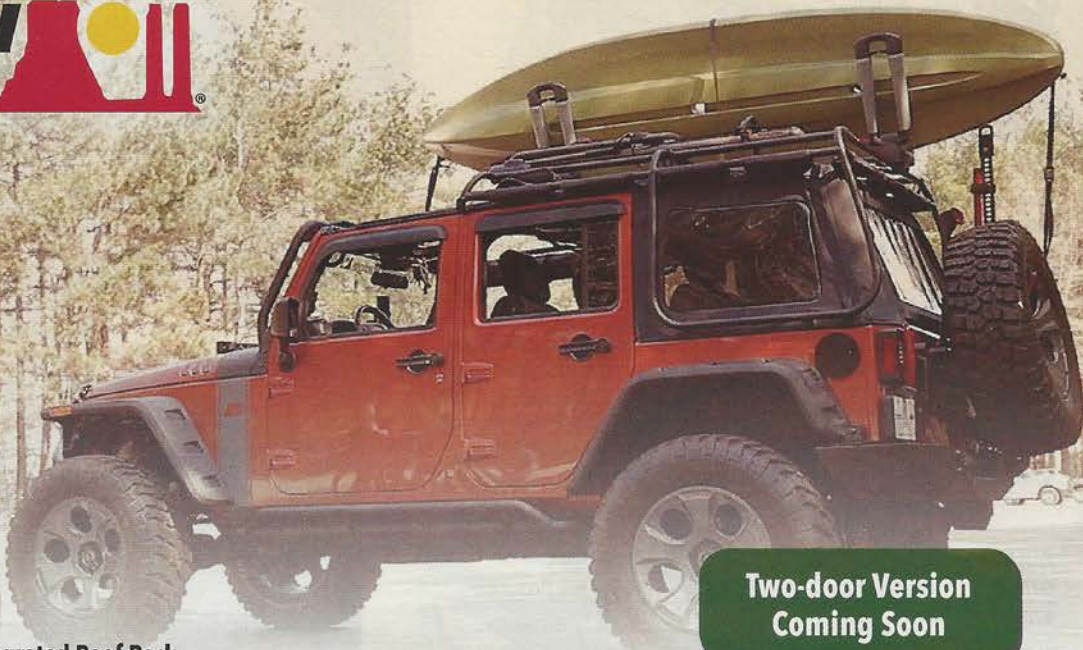

Exo-Top Replacement Soft Top and Integrated Roof Rack

**Two-door Version
Coming Soon**

The Exo-Top is an innovative new design that for the first time ever combines the joy of top-down driving with the utility of a roof rack, taking convenience, function, and style to new levels. By combining the soft top and roof rack, the Exo-Top allows owners to fully utilize their JK for any lifestyle hobby they may have. This new top also features an innovative Sun Slider retractable function which allows the top to slide back with the release of just two latches, creating an open-top experience for owners without the hassle of getting out of the driver's seat. Integrated into the 300-lb. capacity roof rack is an advanced externally suspended soft-top design that fastens using a series of Velcro straps along the perimeter bars of the roof rack. The Exo-Top features a patent-pending design that is a direct bolt-on application with no drilling required.

Part No. 1351602 - 07-15 JK Unlimited



NEW



Black Diamond Bowless Soft Top

Replace your worn out soft top just in time for the summer season with the Rugged Ridge Bowless Top Systems. Available in black diamond, this distinctive fully enclosed design quickly converts from a full top to a Savannah top, taking you from ceiling to sky in seconds and eliminating the need for the bulky OE soft top frame.

Part No. 1375039 - 07-16 Two Door Wrangler
Part No. 1375038 - 07-16 4-Door Wrangler

Complete Soft Top with Frame

- Factory-grade materials and colors
- DOT-compliant windows - available in factory clear vinyl or dark privacy tint (35%)
- Weatherproof - heat-sealed seams and windows and marine-grade molded tooth zippers
- Replaceable components, including side and rear windows with heavy-duty molded tooth zippers - run smoother and last longer
- 2-Year warranty

Part No.	Application
97-06 Jeep® Wrangler	
68317	With soft upper doors, spice
68335	With soft upper doors, black diamond
68336	With soft upper doors, khaki diamond
68517	With soft upper doors, spice with tint
68536	With soft upper doors, khaki with tint
68717	Full steel doors, spice
68735	Full steel doors, black diamond
68736	Full steel doors, khaki
68817	Full steel doors, spice w/tint
68835	Full steel doors, black diamond with tint
68836	Full steel doors, khaki w/tint

Factory Replacement Top For JK, TJ, and YJ

- Soft top produced to OE specs - factory grade
- DOT compliant windows (30 mil) - available in factory clear vinyl or dark privacy tint (35%)
- Weatherproof - heat sealed seams and windows and marine-grade molded tooth zippers
- Replaceable components including side and rear windows with heavy-duty molded tooth zippers - front window frames and door skins
- Fade-resistant marine-grade, wick-stop thread - seals the stitch holes to repel moisture, longer life without color fade
- Self correcting zippers on all door windows. Marine grade molded tooth zippers run smoother and last longer
- Rear windows zip out completely
- Door panels have a double adjusting system that ensures a snug, tight fit
- Kits include fabric/glass only.

Original equipment soft top hardware and door frames required for installation.

TJ Jeep® 97-06 Wrangler

Part No.	Application
99315	Full Steel Doors, Denim Black with Tinted Windows
99335	Full Steel Doors, Black Diamond with Tinted Windows
99515	With soft upper doors, Denim Black with Tinted Windows
99517	With soft upper doors, Spice with Tinted Windows
99535	With soft upper doors, Black Diamond with Tinted Windows
99536	With soft upper doors, Khaki with Tinted Windows
99715	With soft upper doors, Denim Black
99717	With soft upper doors, Spice
99735	With soft upper doors, Black Diamond



Frameless and Trail Top Plus Soft Tops

- Trail Top Plus includes door surrounds, header channel and tail gate bar
- Factory-grade materials and colors
- DOT-Compliant Windows with privacy tint
- Weatherproof - Attaches to factory belt rail system and windshield channel - heat-sealed seams and windows and marine-grade molded tooth zippers
- Replaceable components including side and rear windows with heavy-duty molded tooth zippers - optional front window frames and door skins
- Exclusive Rampage interior storage pockets for both driver and passenger
- Door Surrounds are required when replacing a hard top or if you do not own a factory soft top



Mesh Brief Top

Mesh Top

- Stop the heat of the sun while keeping the cool breeze flowing
- Constructed of a durable UV-treated mesh fabric specially designed to block the heat while letting the cool breeze flow through
- Windshield channel required for all applications

Part No.	Application
91804	Mesh Summer 07-14 JK 2Dr
91806	Mesh Summer 07-14 JK 4Dr

Part No.	Application
Bowless Soft Top Kit	
109535	97-06 TJ Wrangler, black diamond with tint
109517	97-06 TJ Wrangler, spice with tint. Half-door applications use original upper door frames and door skins or these can be purchased separately
89735	97-06 Wrangler, door skin only (pair), black diamond
89799	97-06 Wrangler window frame only (pair)
901004	97-06 Wrangler windshield channel
77015	97-06 Wrangler tailgate bar
Trail Top Plus	
109435	92-95 YJ
109735	97-06 TJ Sailcloth
109835	07-16 JK 4 Door
109935	07-16 JK 2 Door
106135	07-16 JK 2DR- Frameless Trail Top Plus in sailcloth
106035	07-16 JK4 DR - Frameless Trail Top Plus in sailcloth
Door Surrounds	
61098	Soft Top Door Surround 07-16 JK Unlimited
61099	Soft Top Door Surround 07-16 JK Two-door

Windshield Channels

For use with Bikini Tops

Part No.	Application
901007	07-16
901004	97-06



California Brief

California Brief Top

- Provides cover from the elements
- Two great styles available, Mesh and Jeep® matched top material
- Durable quick-release buckles for easy on, easy off installation
- Stop the heat of the sun while keeping the cool breeze flowing with Summer Brief
- Matching OE-Style colors
- Windshield channel required for all applications

Part No.	Application
93315	97-06 Wrangler and Unlimited Brief - Black
93317	97-06 Wrangler and Unlimited Brief - Spice



HOSS™ Hardtop Organized Storage System

The HOSS™ is a one-of-a-kind, integrated storage system that has everything for Jeep® owners to protect, store and organize their hardtops, doors and accessories, all in one place.

- Stores Jeep® CJ and Wrangler factory and aftermarket hardtops
- Cart attaches to back of hardtop on vehicle enabling easy removal
- Protects rear window during removal without clamps
- Padded to protect your investment
- Door cart stores a variety of door configurations and Jeep® accessories
- HOSS™ cover protects items from elements; sold separately



HOSS Hard Top, Door and Accessory Storage Part No.	Hardtop Cart Only Part No.	Hoss Cover Part No.	Application
4280501	4280601	4280709	07-16 Wrangler 2 Door
4280501	4280601	4280809	07-16 Wrangler 4 Door
4280101	4280401	4280209	86-06 Wrangler

Sunrider® For Hardtop Wrangler

- It's an all-purpose, all-weather, year-round replacement for bulky Freedom Panels
- Completely assembled, ready to install to replace those bulky factory hardtop front panels - removes completely if desired
- Unique folding design lets you flip the panel back for an open-sky ride, or simply pull it forward and latch to the windshield header just like the original panels

Part No. 5245017 - 07-16 Wrangler 2-Door and Unlimited - Black Twill
 Part No. 5245035 - 07-16 Wrangler 2-Door and Unlimited - Black Diamond



NEW



Powered Hard Top Hoist

The powered hard top hoist by Smittybilt will be the most convenient tool in your garage. The power hoist comes equipped with a 200 AMP 1/3 HP AC motor that can lift up to 1000 lbs which will make removing and reinstalling your hard top a snap.

Part No. 510001



Soft Top Window Storage Bag

- Window bag stores and protects side windows and framed soft upper doors
- Includes foam padding to prevent scratching

Part No. 595101



Chrome Trim Accessories

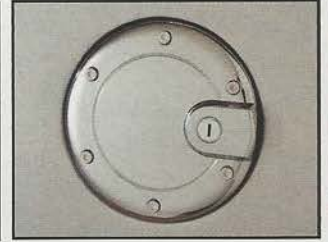

Chrome Trim

Door Handle Covers		Mirror Covers		Fuel Door Covers		Year	Make/Model
Part No.	Part No.	Part No.	Part No.	Part No.	Part No.		
402122	402121	N/A	N/A			12-14	Grand Cherokee
402003	402006	N/A	N/A			99-04	Grand Cherokee (without Passenger Keyhole)
402015	402006	N/A	N/A			99-04	Grand Cherokee (without Passenger Keyhole) (includes rear hatch handle without rear hatch keyhole)
402019	402021	400933				05-10	Grand Cherokee (without Passenger Keyhole)
400598	N/A	N/A	N/A			07-14	Compass
402003	402016	N/A	N/A			04-07	Liberty (without Passenger keyhole)
402018	402016	N/A	N/A			02-05	Liberty (without Passenger Keyhole) (includes rear hatch handle without tailgate keyhole)
N/A	402016	N/A	N/A			04-05	Liberty (with Passenger keyhole) (includes rear hatch handle with keyhole)
402130	N/A	N/A	N/A			07-16	Patriot
401054	400121	400938				07-16	Wrangler (2 Door) with Tailgate Handle
401055	400121	400939				07-16	Wrangler (4 Door) with Tailgate Handle also fits Sahara Edition
401046	400121	400939				07-16	Wrangler 4 Door



Fuel Doors

Black Mountain Black Locking Fuel Door for JK. Easy screw-in installation dresses up the open fuel door and adds some security to your gas tank.



Part No.	Application
BM13889	Powder Coated Black - Locking
BM13890	Powder Coated Black - Non Locking
BM13887	Polished Stainless Steel - Locking
BM13888	Polished Stainless Steel - Non Locking
BM13889W	White Steel - Locking
BM13890W	White Steel - Non Locking

Light Guard Kit

Beef up your Jeep® and protect your lights with this Black Mountain Light Guard kit – chrome or black finishes will help compliment your color scheme.

Kit Includes: Two headlight guards, two side marker guards, two turn signal guards, two taillight guards, and mounting hardware

Part No.	Application
BM138914B	07-15 Wrangler - Black
BM138914W	07-15 Wrangler - White



Flip Up License Plate Hinge

Easily access your winch and roller fairlead with a license plate installed. Enjoy the sturdy look and rugged finish to match your Jeep®. Includes mounting hardware.

*Fairlead NOT included

Part No. RFFLP - Steel - Black



Door Locks

Secure your doors from theft with our Jeep® Door Locks.

Part No.	Application
DRLOCK2DR	07-15 Wrangler - 2 Door
DRLOCK4DR	07-15 Wrangler - 4 Door

NEW

TERAFLEX

JK ActionTruck Conversion Kit

The ActionTruck by Thaler Design is a complete truck conversion kit that is designed with simplicity and ease of installation. The unique bolt-on kit can be installed in a day in your driveway with no expensive tools or equipment. The one-piece hand laid fiberglass bed is designed to install easily over the existing cargo area of the Jeep® Unlimited. The hardtop features a hinged rear window for rear cargo access, and a removable one-piece sun top for open air driving. Sport bar braces bolt to factory sport bar tie-in points. Rear door cargo access is retained with a door filler incorporating an integrated side access panel to gain easy entry to the rear cabin cargo area. The ActionTruck by Thaler Design is truly an understated truck conversion kit with factory styling and attention to detail.

Part No. 18616 - 07-15 JK Wrangler Unlimited 4 door

Note: ActionTruck is primarily to enhance the aesthetic appearance of the Jeep®. No safety characteristics are expressed or implied and should not be relied upon to contain or protect occupants in the event of an accident or falling objects. Never operate the Jeep® in excess of the vehicle manufacturer's specifications.



Mirror Relocation Brackets

- Allows use of factory mirrors when the doors are removed
- Attaches to windshield hinges using existing bolt holes
- No drilling required
- Sold in pairs

Part No.	Application
8685	87-95 Wrangler, Black
8691	97-06 Wrangler, Black*
7491	97-06 Wrangler, Stainless Steel*

*03-06 if you replace with 7504 mirror

Self Contained Electric Power Mirror

- Easy installation using factory mounts and requires minor drilling to create wire route for connection to interior door panel mirror adjustment control
- Plug and Play wiring with a single connection from outside mirror to interior control pad

07-16 Wrangler JK 2 Door and Unlimited

Part No. 8600 - Driver Side (Left)

Part No. 8601 - Pass Side (Right)

97-06 Wrangler TJ/LJ

Part No. 8500 - Driver Side (L)

Part No. 8501 - Driver Side (Right)



Aluminum Hood Latches 07-16 JK Wranglers



Part No. 1111607 - Silver



Part No. 1121011 - Black



Gas Filler Housing

Direct replacement- no drilling required

Part No. 7508

Chrome, 97-06 Wrangler and Unlimited

Windshield Hinges

- Sold in pairs
- Pre-drilled for easy mirror installation
- Oversized design covers paint
- Complete with upper door hinge mount

Part No.	Application
7403	Stainless Steel, 76-95 CJ and Wrangler
7493	Stainless Steel, 97-06 Wrangler
7603	Black, 76-95 CJ and Wrangler



Billet Style Gas Cover

- Locking and non-Locking
- Quality aluminum with a polished finish
- Resistant to gasoline and other hazardous chemicals
- Locking fuel doors provide maximum security - include two keys
- Easy installation without drilling - on most applications



Locking Fuel Doors

Polished	Black	
Part No.	Part No.	Year/Model
—	85006	97-06 Wrangler, TJ and Unlimited
85001	85007	07-16 JK - 2 Door and 4 Door, polished stainless

Non-Locking Fuel Doors

Polished	Black	
Part No.	Part No.	Year/Model
75000	—	97-06 Wrangler, TJ and Unlimited
75001	75007	07-16 JK - 2 Door and 4 Door



Front Euro Light Guards

- Durable design protects your headlights and turn signal lights
- Easy to install - no drilling required

Stainless Part No.	Black Part No.	Application
5459	5659	87-95 Wrangler Headlight Guard, 4 Piece Kit
5480	5660	97-06 Wrangler Headlight Guard, 2 Piece
5470	—	97-06 Wrangler Signal Light Covers, 4 Piece
5480	—	97-06 Wrangler Front Euro Light Guard, 6 Piece Kit
85460	85660	07-16 JK Front Euro Light Guard, 6 Piece Kit

Hood Latch Kits

- Sold in pairs
- Install easily without drilling



Part No.	Application
7401	Stainless Steel, 56-95 Jeep® Models
74334	Cast Stainless Hood Catch, 97-06 Wrangler
7601	Black, Hood Catch, 59-95 CJ and Wrangler
74335	Polished Stainless Hood Catch, 07-16 JK 2 Door and 4 Door
76336	Powder Coated Black, 07-16 JK Wrangler



Windshield Hinge Light Brackets

Mounts to your windshield hinges without drilling

Part No.	Application
7609	Black, 76-95 CJ7 and Wrangler
7608	Black, 97-06 Wrangler



Rear Euro Light Guards

- Available in black and stainless steel
- Easy no-drill installation
- Comes complete with hardware and weathertight seal

Part No.	Application
8460	Stainless Steel, 76-06 Wrangler and Unlimited
88460	Stainless Steel, 07-16 JK 2 Door and 4 Door
8660	Black, 76-06 Wrangler and Unlimited
88660	Black, 07-16 JK 2 Door and 4 Door



Complete Hood Kit

- Complete set for the ultimate look
- Includes set of hood hinges, windshield tie down kit, hood vent, footman loop, and hood catches (except 7465)



Part No.	Application
7499	Stainless Steel, 78-95 CJ and Wrangler
7699	Black, 78-95 CJ and Wrangler
7465	Stainless Steel, 98-06 Wrangler 07-16 JK 2 Door and 4 Door
87466	Polished Stainless (2 hinges, 2 hood stop, footman loop)

TrailBlade Wiper Blades

- Patented Double Blade Technology provides excellent on and off-road windshield cleaning – scrubbing and wiping simultaneously
- Raised scrubbers on the leading wiper edge agitate windshield debris and the second blade cleans and clears the glass
- Unique rubber compound creates a durable and flexible dual blade wiper for unmatched all weather performance
- Each assembly includes a dual blade wiper, frame and universal adapters to fit original equipment wiper arms on most vehicle applications
- Available in sizes 11" to 28"



10000/20000 Series





Heat Reduction Hood



- Performance style steel heat reduction hood
- Includes air vent covers
- Ready-for-paint black primer finish

Part No. **BM28213** - 07-16 Jeep® Wrangler



Duraflex Jeep® Hoods



- High quality 6 oz. fiberglass
- High quality mesh grille (where applicable)
- Hardware kit included
- Includes general instruction guide
- Duraflex products obtain a much higher durability rate than the average fiberglass product, reducing damage rates up to 75%

Part No. **108804** - 07-15 Wrangler - 1 Piece

Part No. **109326** - 11-16 Grand Cherokee - without hood scoops



"Venom" Heat Extraction Hood



Introducing the all-new Venom Hood by Owens Products. A fully functioning heat extraction hood ready to transform your Jeep™ into the aggressive style you have been looking for. Constructed of fiberglass and reinforced with aluminum strength supports, the Venom Hood nearly reduces the weight by 50% and will keep a solid structure for rock crawling and off-road use. Let your engine breathe and make your statement with the Venom Hood.



With stamped steel construction and a factory-style inner structure, this hood fits like the original while creating 50% more vented surface area than other performance hoods on the market today. The SRT inspired design gives a great aggressive look. Vents are removable to make it easier to paint. Uses factory attachment points.

Part No. **1775901**



Hood Vents and Cowls for JK

- You no longer have to replace the entire hood to reduce heat
- Industry's first fully-functioning Hood Cowl channels air for truly functional air directional chambers
- Maintains the factory under hood insulation
- Easy to install
- Fully functional

Part No. **KJ71049BK** - Center Hood Vent - Single

Part No. **KJ71048BK** - Side Hood Vent - Set of 2

Part No. **KJ71050BK** - Vented Hood Cowl

Part No. **KJ71049BK**





LUND
Premium Style. Lasting Performance.

Interceptor™ Wrap Bug Shield

- Full height, wraparound design
- Smoke shields constructed from virtually unbreakable polycarbonate
- Stands away from hood for easy cleaning; no bumpers required for most applications
- Easy to install with low-profile mounting hardware included
- "No drill" installation on popular applications

Part No. 18087—97-06 Wrangler
 Part No. 18467—05-10 Grand Cherokee
 Part No. 18716—07-16 Wrangler
 Part No. 18824—11-16 Grand Cherokee Laredo



In-Channel Wind Deflectors



Air Intake



Bugshield

Jeep® Wrangler JK Accessories

Part No.	Year	Model
7215001	07-16	Air Intake
7251062	07-16	Skytop Front Piece Only
7251064	07-16	Skytop Combo
7220102	07-16	Top Wind Deflector
7251465	07-16	In-Channel Wind Deflectors, 2-Piece
7251495	07-16	Unlimited 4 door In-Channel Wind Deflectors, 4-Piece
7290150	07-16	Unlimited Platinum Bug Shield, Smoke



Ahead of the Curve.

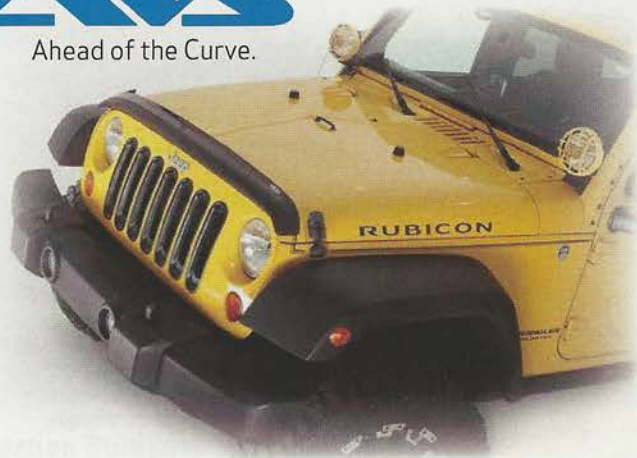

Bugflector II® Stone and Bug Deflector

- Wraparound design offers a sleek, aerodynamic appearance
- Car-wash safe
- Available in dark smoke or paintable clear acrylic
- Upright "Stand Off the Hood" design permits easy hood cleaning and waxing

Part No.	Application
24132	07-10 Compass
25073	11-16 Grand Cherokee
24001	08-12 Liberty
24830	07-16 Patriot
24901	07-16 Wrangler



In-Channel Ventvisor®

- Keeps rain out and lets fresh air in
- Reduce heat in parked vehicle by allowing windows to be kept open just the right amount
- Snug secure fit

Part No. 194650 - 99-04 Grand Cherokee
 Part No. 194249 - 07-16 Wrangler
 Part No. 194252 - 11-16 Grand Cherokee



Chrome Hood Shields

- Thick "OEM-quality" chrome-plated AVS is corrosion resistant
- Matches vehicle's chrome trim for a consistent look

Part No. 680905—05-10 Grand Cherokee



Ahead of the Curve.



Ventvisor® Deflectors

- Keeps rain out and lets fresh air in
- Easy to install, no-drill installation

Part No. 94252 - 11-16 Grand Cherokee
 Part No. 92328 - 07-16 Wrangler 2-door
 Part No. 94249 - 07-16 Wrangler Unlimited
 Part No. 94243 - 05-10 Grand Cherokee
 Part No. 94964 - 08-12 Liberty
 Part No. 92054 - 97-06-Wrangler

WeatherTech®

Side Window Deflectors

- Maximize fresh air
- Sleek aerodynamic styling
- Reduces wind noise

Part No. 80443 - 07-16 Wrangler
 Part No. 82562 - 11-16 Grand Cherokee
 Part No. 82443 - 07-16 Wrangler



STAMPEDE™ AUTOMOTIVE ACCESSORIES



VP Series Hood Shield

- Blends perfectly into the vehicle's appearance
- Stand away design for easy cleaning and to prevent paint damage
- Many applications install into factory holes and require no drilling

291100 Series - Wranglers
 291300 Series - Grand Cherokees

Tape-Onz

- Banish stuffy air, foggy windows, and rain-drenched sleeves from your vehicle forever.
- With Smoke Side Window Deflectors, you can let fresh air in while blocking out wind and weather.

Smoke Part No.	Application
69232	07-16 Wrangler 2 Door
69162	05-10 Grand Cherokee

Smoke Part No.	Application
69342	11-16 Grand Cherokee
69222	07-16 Compass



Ahead of the Curve.



Aeroskin™

- Contours and flush mounts for skin tight fit to the hood
- Unmatched protection for the hood
- Sleek, stylish aerodynamic appearance
- Lowest profile on the market
- Virtually indestructible
- Custom molded, sleek design follows body lines



Part No.	Application
322060	07-16 Wrangler - Smoke
377060	07-16 Wrangler - Matte Black
622060	07-16 Wrangler - Chrome



In-Channel Window Visors

- Two designs to choose from include dark smoke or light smoke finishes
- Installs in record time
- Fits snugly into the upper channel of the window for a modern, stylish effect
- Features a thicker, sturdier material
- Provides the window with full coverage from top to bottom

Part No.	Application
574931	99-04 Grand Cherokee 4 Piece
575031	05-10 Grand Cherokee 4 Piece
574921	02-07 Liberty



Spartan Grille



- Designed to appeal to avid Jeep® enthusiasts
- Extreme versatility with interchangeable inserts
- Easily paintable and is injection molded for a precise factory-like fit
- Steel mesh construction and a larger opening provides better air flow and cooling

Part No.	Description
1203401	Spartan Grille; Black with Black Screen
1203421	Star Mesh Grille Insert
1203422	American Flag Grille Insert
1203424	Monster Teeth Mesh Grille Insert
1203433	Spartan Grill; Black with Skull and Crossbones Screen
1203423	Skull and Crossbones Insert

BLACK MOUNTAIN



Angry Grille

Give your Jeep® an entirely new look and attitude. The intimidation-factor is just as important as comfort; sometimes even more important when it comes to us Jeep® lovers. The 'Angry Grille' is the perfect aftermarket part to speak louder than words. Scowl at everybody in the passing lane and on the hill with Black Mountain's Angry Grill.

Image is of a painted grille, grilles do not come painted.

Part No. BMAG01 - 07-15 Wrangler

PILOT™ AUTOMOTIVE

Imposter Grille

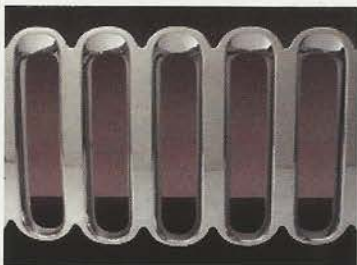

- Designed to install over factory grille in minutes
- Bright chrome finish
- No cutting, drilling, or bolting; just snap into place and/or install with pre-applied adhesive tape

Part No. GI39 —
07-16 Wrangler, 1-piece,
Tape and Clip on

UNDERCOVER TRUCK BED COVERS

Nighthawk Light Brow for JK

NEW



Painted to match from our state of the art paint facility, the brow is ready for install fresh out of the box. In less than 5 Minutes with no drilling required, your Light Brow can be mounted on your factory grille, instantly enhancing your Jeep's® front end styling. Built from high density ABS, Nighthawk is trail-tested and road proven. Sleek, low profile, and downright sexy: go from stock to not, with the Nighthawk Light Brow by UnderCover.

Part No.	Paint Code/Color
NH1001	Raw Unpainted
NH1001PW7	PW7 Bright White
NH1001PX8	PX8 Black
NH1001PSC	PSC Billet Silver
NH1001PR4	PR4 Flame Red
NH1001PRC	PRC Firecracker Red
NH1001PAU	PAU Granite Crystal
NH1001PDS	PDS Anvil
NH1001PGK	PGK Tank

T-REX GRILLES

Torch Series Grille



- Greatest possible light output without compromising grille functionality
- Brilliant combination of flood and spotlights to illuminate the darkest of nights
- Grilles come fully assembled and ready to mount
- Requires part no. 639HAR1

Part No. 6314831 - 07-16 Wrangler, Black

RAMPAGE PRODUCTS

One Piece 3D Grille

Part No.	Application
86512	JK 07-16 2 Door and 4 Door, Black
86513	JK 07-16 2 Door and 4 Door, Black with polished highlights
86514	TJ 97-06, Black



- Single-piece formed grille specifically designed for Jeep® factory grille shell
- Heavy-duty steel construction with protective powder-coat or clear coat finishes
- Two attractive finishes – gloss black powder-coat or dual color black powder-coat with polished, clear-coat highlights
- Attaches to underside of grille for secure installation and factory OE look

Chrome Grille Inserts



- Constructed of chrome plastic - will not rust, corrode, or peel
- Snap into standard grille without drilling

Part No.	Application
7511	Chrome, 97-06 Wrangler
87511	Chrome, 07-15 JK 2 Door and 4 Door

BEDRUG

PREMIUM LINER FOR JEEP®

Designed Trail Tough

Now Available For
JEEP® CJ-7 and YJ



- Looks and feels like carpet
- Custom molded for a perfect fit
- Easy to install, remove and clean
- Insulates from noise and heat

BedRug Tailgate Mats

The BedRug Tailgate Mat will give you the look and feel of carpet in an ultra-tough 100% polypropylene (essentially plastic) product. It will protect your tailgate while standing up to whatever you can throw at it: from mulch to bleach.

- Fade and UV resistant
- Doesn't absorb water; will not mold or mildew
- Looks and feels like carpet



NEW

Part No.	Application
BRJTJG	97-06 Wrangler TJ
BRYJTG	87-95 Wrangler YJ
BRJKTG	07-16 Wrangler JK

Part No.	Application	
Front Kits		
BRCYJ76F	76-95 Wrangler CJ-7/YJ	8pc Kit
BRTJ97F	97-06 Wrangler TJ/LJ (w/Console)	3pc Kit
BRTJ97FNC	97-06 Wrangler TJ/LJ (w/o Console)	3pc Kit
BRJK07F2	07-10 Wrangler JK 2Dr	3pc Kit
BRJK11F2	11-16 Wrangler JK 2Dr	3pc Kit
BRJK07F4	07-16 Wrangler JK Unlimited 4Dr	4pc Kit
Rear Kits		
BRCJ81R	81-86 Wrangler CJ-7	4pc Kit
BRYJ87R	87-95 Wrangler YJ	4pc Kit
BRTJ97R	97-06 Wrangler TJ	4pc Kit
BRLJ04R	04-06 Wrangler LJ	4pc Kit
BRJK07R2	07-10 Wrangler JK 2Dr	5pc Kit
BRJK11R2	11-16 Wrangler JK 2Dr	5pc Kit
BRJK07R4	07-10 Wrangler JK Unlimited 4Dr	5pc Kit
BRJK11R4	11-16 Wrangler JK Unlimited 4Dr	5pc Kit

BEDTRED

PREMIUM LINER FOR JEEP®

Rugged Spray-In Look

Available For
JEEP® JK and TJ



- High-end, rugged spray-in look
- Custom molded for a perfect fit
- Easy to install, remove and clean
- Insulates from noise and heat

Part No.	Application	
Front Kits		
BTTJ97F	97-06 Wrangler TJ/LJ (w/Console)	3pc Kit
BTTJ97FNC	97-06 Wrangler TJ/LJ (w/o Console)	3pc Kit
BTJK07F2	07-10 Wrangler JK 2Dr	3pc Kit
BTJK11F2	11-16 Wrangler JK 2Dr	3pc Kit
Rear Kits		
BTLJ04R	04-06 Wrangler LJ	4pc Kit
BTTJ97R	97-06 Wrangler TJ	4pc Kit
BTJK07R2	07-10 Wrangler JK 2Dr	5pc Kit
BTJK11R2	11-16 Wrangler JK 2Dr	5pc Kit
BTJK07R4	07-10 Wrangler JK Unlimited 4Dr	5pc Kit
BTJK11R4	11-16 Wrangler JK Unlimited 4Dr	5pc Kit



Bestop
Fit. Function. Style.



TrailMax™ II Pro Seats

- New recliner lever allows for quick and easy reclining with 20 position adjustments
- Adjustable headrest that telescopes up and down, and pivots forward and back for utmost comfort
- Enhanced performance bolsters and sculpted lumbar support also provide seating comfort as well as stability
- Elastic mesh map pocket offers handy access storage
- Seats available in complementary vinyl and cloth fabric combinations



TrailMax™ II Sport Seats

- Rotary recliner dial mounts to either side of the seat, allowing its use for driver or passenger side
- Built-in headrest
- Elastic mesh map pocket offers handy access storage
- Seats available in complementary vinyl and cloth fabric combinations



TrailMax™ II Seats

- Stationary high-back fixed seats
- Built-in headrest

TrailMax™ II Fold and Tumble

- Dual headrests
- Seats available in complementary vinyl and cloth fabric combinations



Black 01	Charcoal 09	Blk Denim 15	Spice 37
TrailMax™ II vinyl colors:			
Slate Insert	Slate Insert	Spice Insert	
Fabric front colors: (where applicable)			

Part No.	Application	Colors Available
TrailMax II Pro - Front		
39451	76-06 CJ and Wrangler, High Back Vinyl, Driver Side	01
39450	76-06 CJ and Wrangler, High Back Vinyl, Passenger Side	01
39461	76-06 CJ and Wrangler, High Back Fabric, Driver Side	09 15
39460	76-06 CJ and Wrangler, High Back Fabric, Passenger Side	09
TrailMax II Sport - Front*		
39434	76-06 CJ and Wrangler, High Back Vinyl	01 15 37
39438	76-06 CJ and Wrangler, High Back Fabric	09 15
TrailMax II - Front*		
39436	76-06 CJ and Wrangler, High Back Vinyl	01 09 15 37
39429	76-06 CJ and Wrangler, Low Back Vinyl	01 37
TrailMax II - Rear Bench		
39437	55-95 CJ and Wrangler, Vinyl Fixed Back	01 15 37
39440	55-95 CJ and Wrangler, Vinyl Fold and Tumble	01 09 15 37
39435	97-06 Wrangler 2 door only, Vinyl Fold and Tumble	01 15
39436	97-06 Wrangler 2 door only, Fabric Fold and Tumble	09 15 37

* TJ vehicles 97-02 require adapter bracket number 5125601 for each seat.
03-06 vehicles require seat slider with adapter #5124501 (Driver) or #5124801 (Passenger).

Seat Hardware

Seat Adapter Bracket

- Kit includes two brackets and instructions for a single seat
- Powder-coated dual brackets allow TrailMax™ seats to adapt to factory riser on 97-02 Wrangler

Part No.	Application
5125601	97-02 Wrangler, Seat Adapter Bracket (Single seat)
5125301	76-95 CJ-7 and Wrangler, Seat Riser Driver Side
5125401	76-95 CJ-7 and Wrangler, Seat Riser Passenger Side
5125501	76-95 CJ-7 and Wrangler, Seat Slider (Single seat)

Seat Slider

- Factory original replacement sliders
- Kit includes 2 gliders, one handle, and a hardware kit for single seat

03-06 Wrangler with TrailMax II Seats

Part No. 5124501 - Driver Side

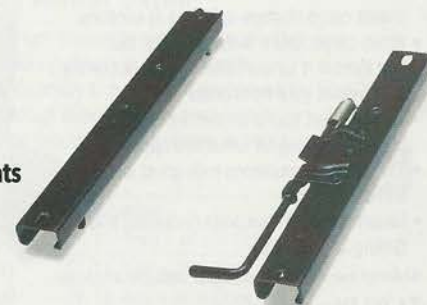

Seat Covers

- Front seat covers sold in pairs, rear seat covers sold individually
- Easy bungee-cord attachment for easy installation
- Custom designed to fit over factory original seats
- Premium vinyl fabric offered in factory original exterior colors



Part No	Application	Colors Available
29225	65-79 CJ-5, 76-80 CJ-7, High Back Bucket (pair)	15
29227	80-83 CJ-5, 76-86 CJ-7, 86-91 Wrangler, High Back Bucket (pair)	04 09 15
29224	92-94 Wrangler (no 95), High Back Bucket (pair)	09 15 37
29226	97-02 Wrangler, High Back Bucket (pair)	09 15 37
29228	03-06 Wrangler and Unlimited, High Back Bucket (pair)	35
29223	80-83 CJ-5, 76-86 CJ-7, 86-95 Wrangler, Rear Bench (Fold and Tumble only)	04 15
29221	97-02 Wrangler, Rear Bench	15
29229	03-06 Wrangler and Unlimited, Rear Bench	35





Billet Replacement Antennas For Jeep® TJ

NEW

Tune in with style! Drake has done it again with another exclusive for your Jeep® exterior. Jeep Antennas are 8" and machined from 6061-T6 Billet Aluminum for strength and style. Also available in black finish.



Part No.	Description
JP190012	Silver
JP190012BK	Black

Aluminum Vent Bezel Trim

Improve the look of your dash with our machined aluminum bezel trim. Adhesive mounted over original plastic trim for easy installation. Four piece set.

Part No. JP180000AL - 07-10 Wrangler

NEW



Split Fold and Tumble

- No need to lose rear passenger space to create cargo storage-split fold in sections
- When cargo space is needed, just fold and tumble it forward and store it out of the way behind your front seats
- Tubular steel frame is covered with tailored pleating for attractive appearance
- Thick padded cushions look great and feel comfortable
- Mounts easily to brackets (included) and drilling is required



**Universal floor mount brackets require drilling for attachment.*

76-02 Wranglers

Part No.	Description
5044901	Black
5044911	Grey
5044915	Denim Black
5044917	Spice



Roll Bar Drink/Cup Holders

- Durable padded drink holders attach to your roll bar with heavy duty hook and loop straps
- Packed in pairs- Great drink storage for rear passengers

Part No. 769901 - Universal (Pair)

Cramp Killer Sport Handles

- Universal, adjustable, hook and loop attachment fits round or square bars - 2" to 5" diameter
- Use anywhere for assess or stability
- Durable 1.5-inch nylon webbing with closed cell foam 'comfort grip' handle
- Unique, flexible 4" wraparound backing plate adds rigidity, prevents bunching and improves handle pull strength



Part No.	Description
769201	Sport Handles, Black, Universal Pair
769301	Deluxe Sport Handles with Comfort Grip, Black, Universal Pair
769101	Dual Strap Sport Handle
779301	Extreme Sport Grab Handle - Rigid Grip with Triple Strap Attachment



Clinometer

- Two gauge designs offer side-by-side angle and front-to-back angle with an optional clinometer compass feature
- Graphic read outs show precise angle in degrees
- Gauges illuminated for night vision (Part # 791005)

Part No.	Description
791005	Universal, without Compass
791006	Universal, with Compass

Hide-A-Step

Now it is easy to get into your Jeep with those large tires! This affordable step is easy to install, and has a convenient quick-disconnect feature.

- Lowers your "step up" 11"
- Pull two pins and the Hide-A-Step will remove easily for off-roading
- Class IV zinc plating protects against harsh winter conditions and road hazards
- Proudly made in the USA.
- Sold individually



Part No.	Description
JKST07	JK Wrangler
JKST0B	JK Wrangler - Black
TJST	TJ Wrangler
TJSTB	TJ Wrangler - Black

NEW



Dead Pedals

This new, three-way adjustable, easy bolt-in JK dead pedal helps with leg fatigue that many of us get while driving when you do not have a place to support your foot, or help brace yourself while wheeling.

NEW



Part No.	Description
DP0709PS	JK Wrangler - Driver Side
DP0709PS	JK Wrangler - Passenger Side
DP9706DS	TJ Wrangler - Driver Side
DP9706PS	TJ Wrangler - Passenger Side

SEATGLOVES

with Moisture Wicking Fabric Panel

- Black stretch fabric border has a non-slip foam backing to help hold the SeatGloves in place
- Easy to clean-just throw in your home washer and dryer
- D3 spacer fabric which provides maximum breathability, insulation, compression resistance and durability
- Fabric stretches to conform to seat style and bolster
- Now available for seats with side airbags

See Manufacturer's Catalog For More Applications

SV Series

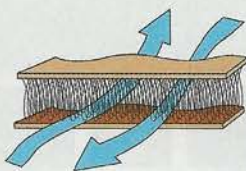

Add Color Code to the end of the Part No.



Gray = GY



Tan = TN



Yellow = YL



Red = RD



Bright Blue = BL



Cargo Area Liners

- Designed to allow split seat backs to work in the up or down position for added cargo flexibility
- Includes a fold-out bumper cover flap for addition protection that easily pulls out from underneath when needed
- Easily attaches around vehicle headrests with adjustable straps and side-release buckles
- Multiple tie-downs, as needed, attach to existing cargo hooks
- Finished edges and custom-fit hook and loop closures for split seat applications

Part No.	Application
PCL6001GY	07-16 Compass/Patriot - Gray
PCL6001TN	07-16 Compass/Patriot - Tan
PCL6002GY	99-16 Grand Cherokee - Gray
PCL6002TN	99-16 Grand Cherokee - Tan
PCL6314BK	11-16 Grand Cherokee - Black
PCL6314GY	11-16 Grand Cherokee - Gray



SeatSaver® Custom-Fitted Seat Covers

- Slip-on/slip-off
- Keeps seats looking new
- Most front seat covers include a handy, built-in map pockets
- Washer/dryer safe for easy home care
- Protect from UV rays
- Breathable fabric that is protected with DWR (durable water repellency) finish, which blocks most accidents from reaching seats
- Gets softer with each wash
- Easy installation/removal
- Pet protection

SS Series



OE30 Series - Original Equipment Seat Covers

- Padded back supports for added comfort
- Form-fit wraparound design - multi-directional stretch trim molds to the contours of the seat
- Highly durable, abrasion-resistant original equipment (OE) standard fabric
- All fabrics are hand washable, lightfast, colorfast, and flame resistant
- Warm in winter, cool in summer

Colors Available:

Charcoal (charcoal - center panel/black - side panel), Gray (light gray - center panel/dark gray - side panel), Taupe (taupe - center panel/mocha - side panel)

Part No.	Application
OE3973 *	07-15 Wrangler JK Bucket Seats with Removable Headrests; Front
OE385	07-15 Sahara/ Rubicon High Back Bucket Seats w/built in headrests, with or without armrests; Front
OE3972	03-06 Wrangler TJ High Back Bucket Seat; Front
OE385	87-95 Wrangler High Back Bucket Seats with built in headrests, with or without armrests; Front
OE34	87-15 Wrangler Bench seats with or without Removable Headrests; Rear (Universal fit)

**Optional Headrest Covers- Part No. HR973 (set of 2) Sold Separately.
When ordering, add C for Charcoal, G for Gray or T for Taupe to the end of the part number.*



Premium Custom Fit Genuine Neoprene Seat Covers

- Super thick CR-Grade neoprene - wetsuit material, quick slip-over installation
- Ultimate protection against dirt, moisture, spills, pets and kids
- Inner layer of waterproof Neoprene plus a water-resistant Neotex outer shell
- Manufactured to the exact specifications of your seats to ensure a perfect fit
- Meets stringent standards for fading, flame resistance, and wear.
- Available in 2-tone yellow, red, blue, gray, tan, charcoal, and solid black
- Custom patterns available for all Jeep® applications

Real Customer Photos



Some popular applications are listed below, many more available.

Part No	Application
SPC118	97-01 TJ 2-Door Solid Black; Front 50/50 Bucket, Two Pull Strap
SPC119	97-01 TJ 2-Door Black/Red; Front 50/50 Bucket, Two Pull Strap
SPC123	97-01 TJ 2-Door Black/Tan; Front 50/50 Bucket, Two Pull Strap
SPC125	03-06 TJ 2-Door Solid Black; Front 50/50 Bucket
SPC126	03-06 TJ 2-Door Black/Red; Front 50/50 Bucket
SPC131	03-06 TJ 2-Door Black/Charcoal; Front 50/50 Bucket
SPC138	97-02 TJ 2-Door Solid Black; Rear Solid Bench
SPC187	07-10 JK 4-Door Black/Charcoal; Front 50/50 Bucket, with remov hdrst, with height adjustable dr. seat, with seat airbag



Solid Black Black/Gray Black/Char. Black/Red Black/Blue Black/Yell Black/Tan

Custom Fit Licensed Camo and Tactical Seat Covers



More than 30 popular camo prints plus military style MOLLE backing.



Catch-It™ Floor Liners

- One-piece design, custom molded to fit each vehicle application
- Tough Vyram® material resists mud, snow, and chemicals, yet rinses clean with a hose
- Raised blocks scrape debris from shoes and drop channels direct liquid to the bottom of the mat
- Available in Black, Gray, or Tan



Front Part No.	Rear Part No.	Application
283105	383105	11-16 Grand Cherokee
283007	383007	05-10 Grand Cherokee
283006	383006	07-16 Wrangler

Catch-It™ Carpet

- Custom molded to each vehicle application
- Tough material resists mud, snow and chemicals, yet rinses clean with a hose
- Heavy-duty carpet scrapes debris from shoes
- Raised lip contains spills, rolled edge for durability



Front Part No.	Rear Part No.	Year	Application
583105B	783105B	11-16	Grand Cherokee
6064449	4264201	07-16	Wrangler JK

Jeep® is a registered trademark of FCA US LLC. More Applications Available.

GEAR SEAT COVERS



- Molle/Pals design allows pouches to be transferred to any backpack or bag with the Molle/Pals attachments
- Fits factory and most aftermarket seats from 1976 to 2006
- Seven individual storage pouches. Additional compartments inside
- Adjustable to accommodate stock or aftermarket seats
- All pouches use military grade snaps, buckles with self correcting zippers



FEATURES:
Pouches can be mounted on front or side cover



G.E.A.R. SEAT COVER	BLACK (01)	TAN (24)	ACU (32)
Jeep® Wrangler 76-15	Front 5661001	5661024	5661032

G.E.A.R. Seat Covers



JK Grab Handles



- Sold in pairs
- Ballistic nylon webbing for added strength
- Extreme molded handle
- High strength steel grommets
- Versatile multi point applications for the front pillars, head rest post and rear sides

Part No.	Application
769311	JK Grab Handle (pr)
769315	Premium GEAR Grab Handle (pr)

Roll Bar Accessories

Part No.	Application
769201	J Sport Handles (pr)
769301	K Deluxe Sport Handles (pr)
769310	L Extreme Sport Handles (pr)
769520	M Mag Flashlight
769550	N Mag MiniLight Holder
769901	O Drink Holders (pr)
769540	P Fire Ext. Holder - 2.5 lbs
769530	Fire Ext. Holder - 1 lb
769510	Q Cell Phone Holder



G.E.A.R. Tailgate Cover

- Interchangeable Pal/Molle storage pouches
- Completely UV stable
- Tailgate covers are manufactured from 600 Denier polyester
- Two individual storage pouches with additional compartments inside

Black	Tan	ACU	Application
Part No.	Part No.	Part No.	
5662201	—	—	97-06 Jeep®
5662301	5662324	5662332	07-15 Jeep® Wrangler



Steering Wheel Installation Kit

- Use to install all Classic, Challenger or Signature Series wheels
- Each kit contains complete step-by-step instructions, a die cast hub, grade 5 hardware and matte black trim pieces

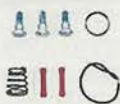

GRANT

Carbon Fiber Steering Wheel

The Grant Racing series steering wheel is made from lightweight anodized aluminum and has the strength to withstand the wear and tear of the most aggressive of driving situations. The black carbon fiber material grip provides comfort where it is needed the most.



Part No. 691



Signature Jeep® Horn Button

Personalize and add style to your steering wheel

Part No.	Application
5675	Plastic, Black Matte, Jeep® Emblem on black
5695	Chrome Plated, Silver Steel, Jeep® Emblem on Black
5648	Plastic, Matte Black, 4 X 4 Emblem On Black

Part No. 3196 - 87-95 Wrangler



Floor and Cargo Liners

- Custom fitting floor mats with a raised lip designed to fit the complex contours of your specific vehicle's carpeted floor areas
- Made with a patented rubberized thermo-plastic material that we guarantee not to crack or break
- Available in Black, Gray, or Tan



Front Part No.	Rear Part No.	Cargo Liner Part No.	Application
30521	—	20531	07-14 Wrangler Unlimited
30521	60521	20521	07-14 Wrangler
3173	61731	21771	04-06 Wrangler Unlimited
3173	61731	21761	03-06 Wrangler
3010	60101	2000	95-01 Cherokee 2/4 Door

Add 1-Black, 2-Gray, or 3-Tan to the end of Part No.



Heavy-Duty Floor Mats

- Features an extra-thick driver's heel pad, providing years of life against normal wear and tear from the driver's heel
- Raised perimeter around our floor mats helps contain spills and debris while embossed ribbing keeps your feet elevated and out of water, mud, and dirt
- Made from a highly durable thermoplastic and guaranteed not to crack or break even in the most extreme conditions
- Available in Black, Gray, or Tan



Front Part No.	Rear Part No.	Application
5108	5202	07-15 Wrangler/Wrangler Unlimited
5106	—	97-06 Wrangler/TJ
—	5202	06-10 Commander

Add 1-Black, 2-Gray, or 3-Tan to the end of Part No.

Second Seat Floor Liners

- Digitally engineered vehicle specific applications fit the complex contours of your vehicle's carpeted floor space exactly
- Easy to install protection that prevents stains and soiling of your carpeted areas and increases your vehicle's resale value
- Patented process features hundreds of tiny nibs on reverse side to minimize liner movement



Black Part No.	Grey Part No.	Application
60101	—	84-01 Cherokee
60601	60602	99-04 Grand Cherokee
60611	60612	05-10 Grand Cherokee

Black Part No.	Grey Part No.	Application
99051	99052	11-15 Grand Cherokee
61731	—	97-06 Wrangler
60541	—	11-15 Wrangler 2 Door
60551	—	11-15 Wrangler 4 Door



X-Act Contour® Floor Mats

- Works great on carpet and vinyl
- DuraGrip™ material is soft and tough
- Formfit Edge™ offers the ultimate in spill containment
- Easy to install, remove, and clean

Front Part No.	2nd Part No.	Year	Application
53561	53661	11-15	Grand Cherokee
53571	-	07-10	Wrangler 2-Door
53571	53581	11-15	Wrangler 2-Door
53571	53671	11-15	Wrangler Unlimited

WeatherBeater™ Floor Protection

- Form-fit Edge™ patented design gives your floor liner a finished look while keeping damaging spills off your doorsill and carpet
- Tough and Durable patented rubberized material is resistant to most chemicals including gasoline, oil, & battery acid
- Add 1-Black, 2- Grey, 3-Tan at end of part number

Front/2nd Part No.	Application
9903	14-15 Cherokee
9905	11-15 Grand Cherokee
1802	07-13 Wrangler - 2 Door (Black/Grey) Fronts Only
1802	11-13 Wrangler Unlimited - 4 Door (Black/Grey) 2nd Seat - 1903

WeatherTech®



All-Vehicle Universal Cargo Mat

Universal Protection, protects vehicle from normal wear and tear. Intelligent design, combined with trim lines allow for a truly custom fit. Tall outer ridges and channels contain and keep fluid away from vehicle's interior.

Part No.	Application
11AVMCB	Black
11AVMCG	Grey
11AVMCT	Tan



All-Weather Floor Mats

- Deeply sculpted channels designed to trap water, road salt, mud, and sand
- Won't curl, crack, or harden in sub-zero weather
- Anti-skid ridges to prevent shifting in your vehicle
- Available in Black, Gray, or Tan

Front Part No.	Rear Part No.	Application
W11	W50	07-16 Wrangler/ Wrangler Unlimited
W3	W50	87-06 Wrangler
W321	W50	14-16 Wrangler

Add: GR-Gray or TN-Tan to the end of part number.

FloorLiner™ DigitalFit®

- A patent pending High-Density Tri-Extruded (HDTE) material allows for a rigid core for strength while offering surface friction to the carpet, as well as tactile feel to the surface
- Advanced surfacing creates channels that carry fluids and debris to a lower reservoir with further channeling to help minimize fluid movement while driving



FloorLiner™

Front Part No.	Rear Part No.	Application
443241	443242	11-15 Grand Cherokee
442661	442662	97-01 Cherokee
441051	441052	07-14 Wrangler/ Wrangler Unlimited
440421	440422	97-06 Wrangler/ 05-06 Wrangler Unlimited
445731	445732	14-16 Wrangler/Wrangler Unlimited

Color Code - 44XXXX - Black, 45XXXX - Tan, 46XXXX - Gray

Cargo Liners

Front Part No.	Application
40324	07-10 Wrangler Unlimited
40469	11-15 Grand Cherokee
40656	14-15 Cherokee
40518	11-14 Wrangler Unlimited
40578	07-16 Patriot/Compass
40745	15-16 Wrangler Unlimited



Floor Liners

Each liner is perfectly contoured to your vehicle's floor for precise secure fitment (floor hook attachment where applicable). The raised lip captures all spills, water and debris keeping your interior pristine. The Chevron-shape patented Deep Tread Technology channels liquid away from your shoes keeping them dry. Made of a durable OE-quality Thermoplastic material that can withstand the rigor of daily abuse.



Part No.	Application
1292001	07-15 Wrangler/Unlimited (JK), Front; Gray
1295001	07-15 Wrangler Unlimited (JK), Rear; Gray
1297501	07-10 Wrangler Unlimited (JK), Cargo; Gray
1298701	07-15 Wrangler Unlimited (JK), Front/Rear; Black
1292011	97-06 Wrangler (TJ), Front, Black
1295002	07-15 2-Door Wrangler (JK) Black, Rear
1297503	11-15 Wrangler/Unlimited (JK), Cargo Liner, Black

More Applications Available

OCF BUMPERS & ACCESSORIES

Part No.	Description	Make	Model	Year-Range
131092	Front Full Width Non Winch Bumper	Jeep®	Wrangler JK	2007-2015
131093	Front Stubby Winch Bumper	Jeep®	Wrangler JK	2007-2015
131094	Front Stubby Non Winch Bumper	Jeep®	Wrangler JK	2007-2015
131095	Rear Full Width Bumper	Jeep®	Wrangler JK	2007-2015
131173	Front Full Width Non Winch Bumper Pkg (Contains Front Bar & D Ring Mounts)	Jeep®	Wrangler JK	2007-2015
131174	Front Full Width Winch Bumper Pkg (Contains Front Bar & D Ring Mounts)	Jeep®	Wrangler JK	2007-2015
131175	Front Stubby Winch Bumper Pkg (Contains Front Bar & D Ring Mounts)	Jeep®	Wrangler JK	2007-2015
131176	Front Stubby Non Winch Bumper Pkg (Contains Front Bar & D Ring Mounts)	Jeep®	Wrangler JK	2007-2015
131177	Rear Full Width Bumper Pkg (Contains D Ring Mounts)	Jeep®	Wrangler JK	2007-2015
182937	Front Full Width Non Winch Bumper Pkg with Formed Light Bar	Jeep®	Wrangler JK	2007-2015
182938	Front Full Width Winch Bumper Pkg with Formed Light Bar	Jeep®	Wrangler JK	2007-2015
182939	Front Stubby Non Winch Bumper Pkg with Formed Light Bar	Jeep®	Wrangler JK	2007-2015
182940	Front Stubby Winch Bumper Pkg with Formed Light Bar	Jeep®	Wrangler JK	2007-2015
131127	D Ring Bracket Mount (sold in pairs)	Jeep®	Wrangler JK	2007-2015
182766	Formed Front Light Bar For OCF Bumpers, Black Coated	Jeep®	Wrangler JK	2007-2015
182720	Bumper Stinger Kit	Jeep®	Wrangler JK	2007-2015
131128	Bumper Light Bar/Grill Guard (fits all OCF JK Bumpers)	Jeep®	Wrangler JK	2007-2015



OCF LED MOUNTING SOLUTIONS FOR JEEP & TRUCK

Part No.	Description	Make	Model	Year-Range
182801	Roof Light Bar Bracket, 50" Rigid Straight Light	Dodge	Ram 1500	2009-2015
182801	Roof Light Bar Bracket, 50" Rigid Straight Light	Dodge	Ram 2500/3500	2010-2015
182854	Roof Light Bar Bracket, 54" Rigid Radius Light	Ford	F-150 including Raptor	2009-2014
182855	Roof Light Bar Bracket, 50" Rigid Straight Light	Ford	F-150 including Raptor	2009-2014
182705	Roof Light Bar Bracket, 54" Rigid Radius Light	Dodge	Ram 1500	2009-2015
182705	Roof Light Bar Bracket, 54" Rigid Radius Light	Dodge	Ram 2500/3500	2010-2015
182736	Hood Light Kit, Black Coated	Jeep®	Wrangler JK	2007-2015
182739	Dual Windshield Pillar Light Kit	Jeep®	Wrangler JK	2007-2015
182746	Formed Windshield Single Light Kit - 50" Light	Jeep®	Wrangler JK	2007-2015
182760	Formed Windshield Dual Light Kit - 50"	Jeep®	Wrangler JK	2007-2015

DISCOVER MORE TRAILS

Superchips Offers More HP & Off-Read Features Than Any Other Jeep Programmer On The Market.

flashpaq FOR JEEP

NEW

Easy-to-use graphic interface, high-resolution color screen, scan features, and tuning levels

- Crawl tune for low speed off-roading in 4WD
- Speed limiter adjustments
- 4WD-hi axle lock
- Speedometer correction for tire size and gear ratio changes
- Diagnostic code read/clear
- Idle up for winching



flashcal FOR JEEP

Part No.	Application
3874	98-14 Jeep® Gas
3876	15-16 Jeep® Gas
3571	Flashcal F5 Jeep® JK Wrangler

TRAILDASH

NEW

TD2

- In-cab monitoring
- Custom background/mystyle
- Color touch screen display
- Video capable
- Screen auto-dim
- Compatible with expandable accessory system (EAS)
- Alerts and records
- Custom pod/mount available
- Display true speed on monitor
- Speedometer correction

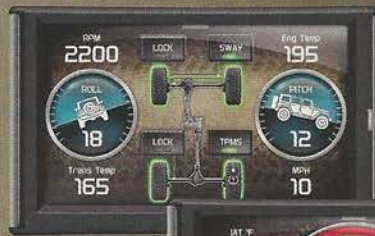

Part No.	Application
42050	TD2 - 03-14 Jeep® Wrangler
438753	98-14 TrailDash1
38302	11-16 Wrangler Dash Pod
38300	98-06 Wrangler Dash Pod
38301	07-10 Wrangler Dash Pod



DIABLOSPORT
GASOLINE AND DIESEL TUNING SYSTEMS



NEW



- All New "Easy Tune" mode for simple tune installation
- Add horsepower and torque while increasing fuel mileage
- OBD-II data logging and clear DTCs
- Adjustable vehicle parameters like tire size, speed limiters and more
- Easy updates via Wi-Fi, PC, or Mac OS X
- Massive Performance Boost
- Faster Processor
- Upgraded Touch Screen Display
- Allows for custom tunes that calibrate for additional bolt-on mods

Part No. i2010 - 05-14 Jeep®

NEW



SuperTuner

On average provides 30+ HP and 40' lbs. of torque.

- Performance Test (0-60, 1/4 Mile testing)
- Speedometer correction and calibration
- Internet updateable
- Tire Size adjustment
- Axle gear ratio adjustment
- Shift point and firmness adjustment
- Speed and rev limiter adjustment
- Diagnostic capability
- Read and clear trouble codes with explanation of codes
- 3 tunes included in the device: Performance, tow and economy
- 50 STATE LEGAL! CARB Certified with existing E.O. numbers on gas

Part No. 49503 - 98-14 Jeep® Gas

HYPERTECH
The World Leader In High-Performance Engine Tuning Products

INTERCEPTOR™
Power Tuning™



Hypertech's new product, the Interceptor, is a smart technology design that works with today's generation of complex engine computers. The Interceptor easily mounts under the hood of a vehicle and plugs into the factory harness to constantly monitor the vehicle's functions. It then automatically recalculates the factory's computer performance calibrations with legendary Hypertech Power Tuning. This means more horsepower and torque, quicker acceleration, better driveability, and improved MPG.

Part No.	Application
705003	11-14 Grand Cherokee 5.7L HEMI™
705005	12-14 Grand Cherokee SRT-8 6.4L HEMI™
705006	12-14 Wrangler JK 3.6L
755006	12-14 Wrangler JK 3.6L (Special Edition Version with Programmer)

NEW



MAX ENERGY 2.0
POWER PROGRAMMER

- More power to save fuel-Hypertech users report 1-3 MPG gains
- Larger backlit LCD screen for quick/easy setup and user-friendly navigation for simple installation, tuning, and feature options
- Reprogram TPMS Pressure Warning For Larger Tires
- Top-Speed Limiter
- Rev Limiter
- Speedometer Calibrator
- 1-4 Skip Shift
- Automatic Transmission Adjustments
- Cooling Fan "On/Off" Temperatures
- V8/V4 Mode Adjustments
- 0-60 MPH Electronic Throttle Restriction

Gas and E85 vehicles get optimized Power Tuning for regular and premium octane with gains up to +48 Hp/+61 Tq Gas/E85 Vehicles (Depending on application)

Part No. 2000 - 07-14 Jeep® Gas



GT PLATINUM GAS

The GT Platinum is four products in one remarkable unit: a vehicle engine tuner, monitor, gauge, and diagnostic device all in a single unit. The remarkable GT transforms the utility of your vehicle by increasing horsepower, improving fuel economy, and providing a comprehensive set of monitoring features and diagnostic functions. Other tuning products don't hold a candle to the Triple Dog GT - it has the largest feature set and the widest range of vehicle applications from a single product.

Part No.	Description
40417	GT Platinum Gas
40410	50-State GT Gas



Power Sprint Booster Controller

- Reduces throttle response time
- Improved acceleration
- Easy to install
- Does not affect the vehicle's electronic system
- Three position settings: factory (off), Sport (green), Race (red)

Part No. 7716203 - Jeep® Wrangler (JK) 14-15 V6 (M/T)
 Part No. 7716204 - Jeep® Wrangler (JK)/Grand Cherokee (WK2) 14-15 V6/V8 (A/T)



Throttle Sensitivity Booster

Boosts throttle sensitivity and engine response to reduce pedal lag and creates snappier driving performance. BD's Throttle Sensitivity Booster is an easy to install module with factory connections and is adjustable to boost throttle signals by 50% or 100%.

Part No. 1057712 - 07-16 Wrangler/Liberty/Grand Cherokee



Performance Modules

Point by point air/fuel, ignition advance, transmission, and various other tuning points provide performance gains of up to 25 HP. Stage 1 is for stock engines; Stage 2 is for vehicles with performance exhaust and thermostat.

Stage 1	Stage 2	
Part No.	Part No.	Application
—	90709S	07-08 Grand Cherokee 6.1L/Auto
90701	—	07-08 Liberty 3.7L/Auto/Man
90710	—	07-08 Wrangler 3.8L/Auto/Man
90910	90910S	09-11 Wrangler 3.8L/Auto/Man
91201	91201S	11-16 Wrangler 3.6L

Adds More Power!

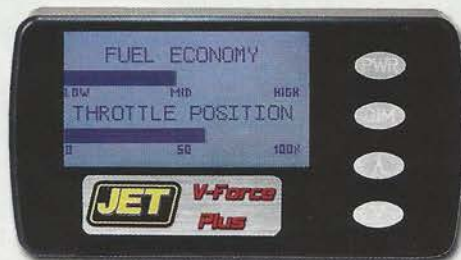

V-Force Plus

The JET V-Force Plus is designed for the performance enthusiast who wants improved performance, acceleration, and the ability to monitor vehicle information. The V-Force Plus will optimize ignition advance and fuel maps for optimum horsepower and drivability. In addition, the software allows the user to select from 14 different screens to monitor throttle position, mass air flow, manifold pressure, fuel economy, and air/fuel ratio.

Part No. 68030 - 97-11 Wrangler TJ/JK, 4 and 6 cyl.



Brute Force Intakes

AEM BRUTE FORCE intakes deliver the most Air Power for your truck, SUV, or fuel-injected muscle car.

- Manufactured and assembled in the USA
- AEM's lifetime DRYFLOW Synthetic air filter is 99.53% efficient in FINE DUST testing, filters dirt as small as one micron, and never needs filter oil!
- 50-state legal or pending legality

Part No.	Application
218314D	07-11 Wrangler 3.8L
218311D	97-06 Wrangler 4.0L
218316DS	12-16 Wrangler 3.6L

Add Color Code to end of Part No. C-Silver, P-Polished



Banks Ram-Air® Intake System

Banks Ram-Air Intake System replaces the factory's flat panel filter with a large conical lifetime filter that provides maximum high-flow filtration. The Ram-Air's opening dwarfs the stock's inlet, without the 90° detours that choke airflow and kill power. The huge inlet, enclosed housing and much larger tubing reduce restrictions, dramatically improving airflow to the cylinders. The results are impressive: Banks Ram-Air outflows the stock intake by 73%, improving the Jeep®'s power and fuel economy.

Part No.	Application
41837	12-16 Wrangler JK 3.6L
41832	07-11 Wrangler JK 3.8L
41816	97-06 Wrangler TJ 4.0L



Air Intake Systems

- For maximum CFM and performance look for Pro 5 R (progressive 5 layers of oiled cotton media)
- For maximum convenience and protection look for Pro Dry S (2 oil free progressive synthetic media layers)
- aFe cold air intakes out-perform all other intakes and produce increased horsepower and torque!

Pro 5R Part No.	Pro Dry S Part No.	Year	Application	Engine
54120921	51120921	12-16	Wrangler	3.6L
5412462	—	14-15	Cherokee	3.2L
—	5110422	91-01	Cherokee	4.0L
—	51112522	07-11	Wrangler	3.8L
—	5110142	97-06	Wrangler	4.0L

Momentum GT Pro 5R Stage-2 Intake System

- Up to +35 hp / +31 lbs. X ft. torque max gains
- Outflows factory intake
- High quality one-piece roto-molded sealed housing featuring carbon fiber accent with auxiliary air scoop
- Cad-designed roto-molded intake tube
- Built-in sight window provides easy inspection of filter without disassembly
- Pro 5R pre-oiled, washable/reusable air filter for maximum performance



Part No.	Application
5476207	Grand Cherokee (WK2) 11-15 V6-3.6L
5476202	Wrangler (TJ) 97-06 I6-4.0L
5476205	Grand Cherokee (WK2) 11-15 V8-5.7L HEMI
5476204	Wrangler (JK) 12-15 V6-3.6L
5476206	Grand Cherokee SRT-8/SRT 12-15 V8-6.4L HEMI
5476213	Wrangler (JK) 07-11 V6-3.8L w/ Mechanical Fan "Middle-East" Edition



The Performance Intake Companion

- Patented helix bore design boosts incoming air charge velocity
- CAD designed and CNC machined T-6061 billet aluminum for precise fit, will not leak
- Emissions compliant in all 50 states

Throttle Body Spacers



Part No.	Application
300637	12-15 Wrangler
310616	07-11 Wrangler
310510	97-06 Wrangler
310511	97-02 Wrangler

Part No.	Application
310510	91-95 Wrangler
310509	03-07 Grand Cherokee
310510	99-04 Grand Cherokee



Snorkel Systems for Jeep® Wrangler

NEW

A safari snorkel system relocates your engine's air intake point from the relatively low and vulnerable position under the hood to a much higher and safer location where a constant source of cool, clean, dry air is available. Install one before your next trip and breathe easier knowing that your engine is protected by a safari snorkel.

Part No.	Application
SS1066HF	07-11 Wrangler (2-4 Door) 3.8L V6 Gas Engine (Left Hand Drive)
SS1070HF	12-16 3.6L Wrangler (2-4 Door) Pentastar V6 (Left Hand Drive)
SS1055HF ^{1,2}	09/99-06 Wrangler TJ/ Wrangler Unlimited 4.0L, Petrol, Right Side Mount ¹
SS1050HF ^{1,2}	To 8/99 Wrangler TJ/4.0L, Petrol, Right Side Mount ¹
SS1000HF ^{1,2}	All Wrangler YJ Inline Six, 4.0L, Petrol, Fuel Injected

¹ Snorkel will interfere with removal of doors.
² 4 cyl. models may need modification.



CAI Intake Kits

- The only polyethylene, fully-boxed intake on the market
- Removable aluminum lid for easy filter access
- Full box offers reduced intake noise compared to open systems

Part No.	Application	Style
175406	00-06 Wrangler TJ/Rubicon 4.0L	Pro-5 Filter
16157	11-15 Cherokee 5.7L	Pro-5 Filter
176386	07-11 Wrangler JK 3.8L	Powercore
17636	12-15 Wrangler JK 3.6L	Pro-5 Filter



Periscoop

- Works with Volant's CAI Intake system
- Protects your filter from moisture, dirt and allows you to make deep water crossings without stalling
- Marine-grade, stainless steel clamps and silicone sleeves to ensure a tight and reliable fit
- Hood seal adaptor funnels air from a hood-mounted snorkel that extends up the passenger side of the vehicle to the roof-line

Part No.	Application	Description
37640	04-06 Wrangler TJ 4.0L	Periscoop snorkel only*
37638	07-11 Wrangler JK 3.8L	Snorkel only
37738	07-11 Wrangler JK 3.8L	Full kit intake and snorkel
377366	12-16 Wrangler JK 3.6L	Periscoop only
37736	12-16 Wrangler JK 3.6L	Full Kit

*Must be used with Intake Kit #175406



XHD Snorkel Kits

- The new Modular XHD Snorkel System from Rugged Ridge relocates the vulnerable stock air intake location to help reduce dust clogged filters and the risk of hydro-locking your engine
- Also the first snorkel designed with the modular functionality of a low mount and ram high mount air intake design
- The Modular XHD Snorkel System comes standard with the pre-filter low mount
- The pre-filter low mount relocates the air intake to just below the windshield and draws cool air from outside the hot engine compartment
- The optional ram high mount design allows the air intake to be extended up an additional 21" to the top of the windshield
- The system is manufactured from premium thermoformed plastic, mandrel bent aluminum and hi-temp silicone connection hoses
- Built-in manual drain valves channel away excess water to prevent it from entering the intake system



Part No.	Application
1775621	12-16 Wrangler 3.6L
1775620	07-11 Wrangler 3.8L



**SUPERIOR AIRFLOW.
SUPERIOR PERFORMANCE.™**

K&N® HIGH-FLOW INTAKE SYSTEMS

- Huge Power Gains and Better Engine Sound
- Easy to Install with No Cutting or Drilling
- Washable and Reusable Air Filter
- Won't Void Factory Warranty
- 10-Year/Million Mile Limited Warranty



GUARANTEED TO INCREASE HORSEPOWER

K&N® JEEP® INTAKE SYSTEMS

Model	Years	Engine	Rotomolded	Note	Est. HP*	Aluminum	Note	Est. HP*
Cherokee	2014-16	3.2L	63-1569	2	+ 8 hp	•	•	•
Cherokee	1996-01	4.0L	57-1518	1	+ 8 hp	•	•	•
Commander	2006-10	3.7L	57-1545	1	+ 8 hp	77-1545KP	1	+ 7 hp
Commander	2006-10	5.7L	57-1549	1	+ 15 hp	77-1549KP	1	+ 13 hp
Commander	2006-09	4.7L	57-1548	1	+ 9 hp	77-1548KP	1	+ 8 hp
Compass	2011-16	2.0L	63-1567	2	+ 6 hp	•	•	•
Compass	2011-16	2.4L	63-1567	2	+ 6 hp	•	•	•
Compass	2007-10	2.4L	57-1552	1	+ 8 hp	•	•	•
Compass	2008-10	2.0L	63-1552	2	+ 8 hp	•	•	•
Compass	2007	2.0L	57-1552	1	+ 8 hp	•	•	•
Grand Cherokee	2011-15	3.6L	•	•	•	77-1560KTK	2	+ 11 hp
Grand Cherokee	2011-15	5.7L	63-1563	2	+ 17 hp	77-1563KP	2	+ 15 hp
Grand Cherokee	2005-10	3.7L	57-1545	1	+ 8 hp	77-1545KP	1	+ 7 hp
Grand Cherokee	2005-10	5.7L	57-1549	1	+ 15 hp	77-1549KP	1	+ 13 hp
Grand Cherokee	2006-10	6.1L	57-1555	1	+ 12 hp	•	•	•
Grand Cherokee	2005-09	4.7L	57-1548	1	+ 10 hp	77-1548KP	1	+ 8 hp
Grand Cherokee	1999-04	4.0L	57-1526	1	+ 8 hp	77-1526KP	1	+ 7 hp
Grand Cherokee	1999-04	4.7L	57-1513-1	1	+ 13 hp	77-1513KP	1	+ 9 hp
Grand Cherokee	1993-98	4.0L	57-1520	1	+ 8 hp	•	•	•
Grand Cherokee	1993-98	5.2L	57-1506-2	1	+ 25 hp	•	•	•
Liberty	2010-12	3.7L	•	•	•	77-1562KTK	2	+ 9 hp
Liberty	2008-09	3.7L	57-1559	1	+ 11 hp	77-1559KP	1	+ 10 hp
Liberty	2004-07	3.7L	57-1540	1	+ 6 hp	77-1540KP	1	+ 6 hp
Liberty	2002-03	3.7L	57-1528	1	+ 9 hp	•	•	•
Patriot	2011-16	2.0L	63-1567	2	+ 6 hp	•	•	•
Patriot	2011-16	2.4L	63-1567	2	+ 6 hp	•	•	•
Patriot	2007-10	2.4L	57-1552	1	+ 8 hp	•	•	•
Patriot	2008-10	2.0L	57-1552	1	+ 8 hp	•	•	•
Wrangler	2012-16	3.6L	63-1566	2	+ 12 hp	77-1566KP	2	+ 10 hp
Wrangler	2007-11	3.8L	57-1553	1	+ 8 hp	77-1553KP	1	+ 8 hp
Wrangler	1997-06	4.0L	57-1514-1	1	+ 12 hp	•	•	•
Wrangler	1991-95	4.0L	57-1521	1,3	+ 13 hp	•	•	•



ROTOMOLDED INTAKE



ALUMINUM INTAKE

INTAKE PART NUMBER PREFIXES:

- 57- 50-State street legal with rotomolded tube
- 63- Rotomolded tube
- 69/77- Mandrel-bent aluminum tube
- 71- Blackhawk Induction™ Intake system

INTAKE PART NUMBER SUFFIXES:

- KS- Metallic silver aluminum tube
- KP- Polished aluminum tube
- KTK- Textured black aluminum tube

1) Street Legal in 50 States
 2) Street Legal in most states, not legal for sale or use in California or other states with similar emission control regulations
 3) Exc. ABS



WELCOME TO THE PASSING LANE.



**SUPERIOR AIRFLOW.
SUPERIOR PERFORMANCE.™**

K&N® HIGH-FLOW AIR FILTERS

- Designed To Increase Horsepower
- Never Needs to be Replaced
- Easy 5-Minute Installation
- Up To 50,000 Miles Between Cleanings (under normal highway driving conditions)
- 10-Year/Million Mile Limited Warranty



Air Filters



K&N RECHARGER®

The only cleaner formulated to clean K&N® high-flow air filters with cotton media. The use of any other cleaning solution can void the filter's warranty, and quite possibly could damage the cotton material. K&N Power Kleen Cleaner works to dissolve the dirt build up and old filter oil, and can be washed away with water.

- 6.5 oz. (204 ml) Spray Oil, 12-fl oz. (355 ml) K&N Power Kleen Air Filter cleaner

K/N99-5000 \$9.99

**K&N WRENCH-OFF®
AUTOMOTIVE OIL FILTERS**

K&N Wrench-Off® oil filters are great for race applications. These canister oil filters are known for their durability, strength and easy wrench-off removal design.



Wrench-Off®
Oil Filters

OIL FILTER PART NUMBER PREFIXES:

HP- Wrench-Off® Canister filter
PS- Pro Series Cartridge filter

DESIGNED TO INCREASE HORSEPOWER

Make/Model	Years	Engine	Note	Air Filter	Oil Filter
Cherokee	2014-16	3.2L	•	33-5009	PS-7026
Cherokee	2014-16	2.4L	•	33-5009	HP-1017
Cherokee	1996-01	4.0L	•	33-2122	HP-2004
Commander	2008-10	5.7L	•	33-2233	HP-2010
Commander	2009-10	3.7L	•	33-2233	HP-2011
Commander	2008-09	4.7L	•	33-2233	HP-2010
Commander	2006-08	3.7L	•	33-2233	HP-2009
Commander	2006-07	4.7L, 5.7L	•	33-2233	HP-2004
Compass	2011-15	2.0L, 2.4L	•	E-1998	HP-1017
Compass	2007-10	2.0L, 2.4L	•	33-2362	HP-1017
Grand Cherokee	2014-16	3.6L	•	33-2457	PS-7026
Grand Cherokee	2011-13	3.6L	•	33-2457	PS-7025
Grand Cherokee	2011-15	5.7L	•	33-2457	HP-2010
Grand Cherokee	2012-15	6.4L	•	33-2457	HP-2010
Grand Cherokee	2014-15	3.0L DSL	•	33-3029	•
Grand Cherokee	2008-10	5.7L	•	33-2233	HP-2010
Grand Cherokee	2009-10	6.1L	•	33-2233	HP-2010
Grand Cherokee	2009-10	3.7L	•	33-2233	HP-2011
Grand Cherokee	2008-09	4.7L	•	33-2233	HP-2010
Grand Cherokee	2008-09	3.0L DSL	•	33-2420	•
Grand Cherokee	2005-08	3.7L	•	33-2233	HP-2009
Grand Cherokee	2005-07	4.7L, 5.7L	•	33-2233	HP-2004
Grand Cherokee	2006-07	6.1L	•	33-2233	HP-2004
Grand Cherokee	1999-04	4.0L	•	33-2139	HP-2004
Grand Cherokee	2002-04	4.7L	1	33-2139	HP-2004
Grand Cherokee	2002-04	4.7L	2	33-2246	HP-2004
Grand Cherokee	1999-01	4.7L	•	33-2139	HP-2004
Grand Cherokee	1993-98	4.0L	•	33-2048	HP-2004
Grand Cherokee	1993-98	5.2L	•	33-2048	HP-2004
Liberty	2009-12	3.7L	•	33-2363	HP-2011
Liberty	2002-07	3.7L	•	33-2233	HP-2009
Liberty	2002-05	2.4L	•	33-2261	HP-1002
Patriot	2011-16	2.0L, 2.4L	•	E-1998	HP-1017
Patriot	2007-10	2.0L, 2.4L	•	33-2362	HP-1017
Wrangler	2014-16	3.6L	•	33-2364	PS-7026
Wrangler	2012-15	3.6L	•	33-2364	PS-7025
Wrangler	2007-11	3.8L	•	33-2364	HP-1002
Wrangler	1998-06	4.0L	•	33-2114	HP-2004
Wrangler	2003-06	2.4L	•	33-2261	HP-1002
Wrangler	1998-02	2.5L	•	33-2114	HP-2004
Wrangler	1991-95	4.0L	•	33-2046	HP-2004
Wrangler	1994-95	2.5L	•	33-2046	HP-2004

1) w/o High Output
2) High Output

PERFORMANCE

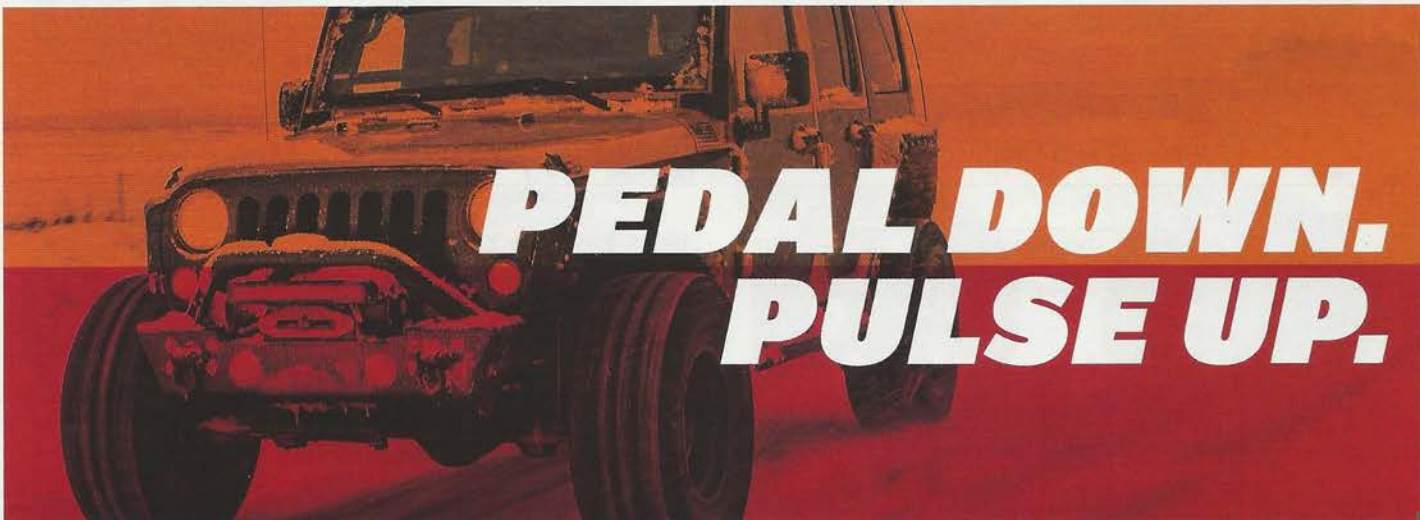



JEEP® PERFORMANCE

CHEROKEE • GRAND CHEROKEE • WRANGLER JK • WRANGLER TJ • WRANGLER YJ

JEEP®	Finish	Tube	Exit	Series	Part No.
CHEROKEE					
2014-2016 L4 2.4L; AWD	Cat-Back	Stainless	2.5"	H	MF 15328
2014-2016 L4 2.4L; FWD	Cat-Back	Stainless	2.5"	H	MF 15293
2014-2016 V6 3.2L; AWD	Cat-Back	Stainless	2.5"	C	MF 15327
2014-2016 V6 3.2L; FWD	Cat-Back	Stainless	2.5"	C	MF 15292
2001 L6 4.0L	Cat-Back	Stainless	2.5"	D	MF 16464
2000 L6 4.0L; From 1/21/00	Cat-Back	Stainless	2.5"	D	MF 16464
2000 L6 4.0L; To 1/20/00	Cat-Back	Stainless	2.5"	D	MF 15856
1996-2000 L4 2.5L	Cat-Back	Stainless	2.5"	D	MF 15856
1996-1999 L6 4.0L	Cat-Back	Stainless	2.5"	D	MF 15856
GRAND CHEROKEE					
2014-2016 V6 3.0L Eco Diesel; Excl. Summit Model	Cat-Back	Stainless	2.25"	C	MF 15317
2014-2016 V6 3.0L Summit Eco Diesel	Cat-Back	Stainless		I	MF 19192
2014-2016 V6 3.6L Summit	Cat-Back	Stainless	2.5"	I	MF 19193
2014-2016 V6 3.6L; Excl. Summit Model	Cat-Back	Black	2.5"	C	MF 19216
	Cat-Back	Stainless	2.5"	C	MF 16929
	Cat-Back	Stainless	2.5"	D	MF 19190
2014-2016 V8 5.7L Summit	Cat-Back	Stainless	2.5"	I	MF 19193
2012-2016 V8 6.4L; SRT-8; Reuse OE Tip	Cat-Back	Stainless	3"	C	MF 15064
2011-2016 V8 5.7L; Excl. Summit Model	Cat-Back	Black	2.5"	C	MF 19216
	Cat-Back	Stainless	2.5"	C	MF 16929
2011-2013 V6 3.6L	Cat-Back	Stainless	2.5"	D	MF 16991
2007-2010 V6 3.7L	Cat-Back	Stainless	2.5"	D	MF 16834
2007-2009 V6 3.0L Diesel	Cat-Back	Stainless		D	MF 16812
2006-2010 V8 6.1L; SRT-8	Cat-Back	Stainless	3"	L	MF 16709
2005-2010 V8 4.7L	Cat-Back	Stainless	2.5"	D	MF 16632
2005-2010 V8 5.7L	Cat-Back	Stainless	2.5"	D	MF 16631
2005-2006 V6 3.7L	Cat-Back	Stainless	2.5"	D	MF 16632
1999-2004 L6 4.0L	Cat-Back	Stainless	2.5"	D	MF 15859
1999-2004 V8 4.7L	Cat-Back	Stainless	2.5"	D	MF 15859
1998 V8 5.9L	Cat-Back	Stainless	2.5"	D	MF 15858
1993-1997 L6 4.0L	Cat-Back	Stainless	2.5"	D	MF 15857
1993-1997 V8 5.2L	Cat-Back	Stainless	2.5"	D	MF 15857

JEEP®	Finish	Tube	Exit	Series	Part No.
WRANGLER JK					
2012-2016 V6 3.6L; 2 Dr	Axle-Back	Black	2.5"	C	MF 15160
	Axle-Back	Stainless	2.5"	C	MF 15178
	Cat-Back	Stainless	2.5"	D	Competition 15118
	Cat-Back	Stainless	2.5"	D	MF 15116
	Cat-Back	Stainless	2.5"	H	Rock Crawler 15236
	Cat-Back	Stainless	2.5"	K	Off Road Pro 17144
2012-2016 V6 3.6L; Unlimited; 4 Dr	Axle-Back	Black	2.5"	C	MF 15160
	Cat-Back	Stainless	2.5"	D	Competition 15117
	Cat-Back	Stainless	2.5"	D	MF 15115
	Cat-Back	Stainless	2.5"	H	Rock Crawler 15237
	Cat-Back	Stainless	2.5"	K	Off Road Pro 17143
2007-2016 V6 3.6L; Unlimited; 4 Dr	Axle-Back	Stainless	2.5"	C	MF 15178
2007-2011 V6 3.8L; 2 Dr	Axle-Back	Black	2.5"	C	MF 15160
	Axle-Back	Stainless	2.5"	C	MF 15178
	Cat-Back	Stainless	2.5"	D	MF 16666
	Cat-Back	Stainless	2.5"	H	Rock Crawler 15238
	Cat-Back	Stainless	2.5"	K	Off Road Pro 17119
2007-2011 V6 3.8L; 2 Dr; Excl. Models W/ Plastic Rear Fascia	Cat-Back	Stainless	2.5"	D	Competition 16393
2007-2011 V6 3.8L; Unlimited; 4 Dr	Axle-Back	Black	2.5"	C	MF 15160
	Cat-Back	Stainless	2.5"	D	Competition 16391
	Cat-Back	Stainless	2.5"	D	MF 16751
	Cat-Back	Stainless	2.5"	H	Rock Crawler 15239
	Cat-Back	Stainless	2.5"	K	Off Road Pro 17120
WRANGLER TJ					
2004-2006 L6 4.0L; Excl. Unlimited	Cat-Back	Stainless	2.5"	D	Competition 16390
	Cat-Back	Stainless	2.5"	D	MF 15855
	Cat-Back	Stainless	2.5"	K	Off Road Pro 17122
2004-2006 L6 4.0L; Unlimited	Cat-Back	Stainless	2.5"	D	Competition 16389
	Cat-Back	Stainless	2.5"	D	MF 16695
	Cat-Back	Stainless	2.5"	K	Off Road Pro 17121
2003-2006 L4 2.4L	Cat-Back	Stainless	2.5"	D	MF 15855
	Cat-Back	Stainless	2.5"	K	Off Road Pro 17122
2000-2003 L6 4.0L	Cat-Back	Stainless	2.5"	D	Competition 16390
	Cat-Back	Stainless	2.5"	D	MF 15855
	Cat-Back	Stainless	2.5"	K	Off Road Pro 17122
2000-2002 L4 2.5L	Cat-Back	Stainless	2.5"	D	Competition 16390
	Cat-Back	Stainless	2.5"	D	MF 15855
	Cat-Back	Stainless	2.5"	K	Off Road Pro 17122
1997-1999 L4 2.5L	Cat-Back	Stainless	2.5"	D	MF 15854
	Cat-Back	Stainless	2.5"	K	Off Road Pro 17125
1997-1999 L6 4.0L	Cat-Back	Stainless	2.5"	D	MF 15854
	Cat-Back	Stainless	2.5"	K	Off Road Pro 17125
WRANGLER YJ					
1991-1995 L4 2.5L	Cat-Back	Stainless	2.5"	D	MF 15853
	Cat-Back	Stainless	2.5"	K	Off Road Pro 17126
1991-1995 L6 4.0L	Cat-Back	Stainless	2.5"	D	MF 15853
	Cat-Back	Stainless	2.5"	K	Off Road Pro 17126

SERIES

MF
Balanced interior/exterior sound levels. Maintains exhaust efficiency.

COMPETITION
Aggressive exhaust note. Reduced system mass.

ROCK CRAWLER
High clearance design for off-road. Accommodates aftermarket bumpers.

OFF ROAD PRO
Aggressive sound and reduced mass. Accommodates modified suspensions.



Borla[®] EXHAUST



Limited Lifetime
WARRANTY

STREET
LEGAL

Stainless Steel Headers

Adds 25 horsepower to your vehicle. Combine with Borla exhaust system and you will get truly awesome performance from your Jeep[®] vehicle! Constructed of high-quality austenitic stainless steel for a lifetime of rust-free performance.



Cat-Back Exhaust Systems

- Runs from the stock catalytic converter to the tailpipe
- Produces up to seven extra rear wheel horsepower
- Hand-built out of high-quality austenitic stainless steel
- Delivers maximum low-end torque and top-end horsepower

Part No.	Application
140245	06-10 Grand Cherokee SRT-8 6.1L dual round rolled angle cut center rear exit
14836	99-04 Grand Cherokee 4.0, 4.7L, single round angle cut phantom tip, rear exit
140217	07-11 Wrangler 3.8L 2DR single sq. angle cut, phantom tip split rear exit
140218	07-11 Wrangler 3.8L 4DR single sq. angle cut, phantom tip split rear exit
140406	11-15 Grand Cherokee 5.7L, single round, rolled, angle cut tip, dual rear exit
140460	12-16 Wrangler 3.6L 2 DR dual split rear exit
140459	12-16 Wrangler 3.6L 4 DR dual split rear exit
11826	12-14 Grand Cherokee SRT-8 6.4L V8 AT AWD 4DR Rear Section "S-Type"
11827	12-14 Grand Cherokee SRT-8 6.4L V8 AT AWD 4DR Rear Section "ATAK"
140632	2015 Grand Cherokee SRT-8 6.4L V8 AT AWD 4DR Cat-Back™ "S-Type"
140633	2015 Grand Cherokee SRT-8 6.4L V8 AT AWD 4DR Cat-Back™ "ATAK"
140644	12-16 Wrangler 3.6L V6 AT/MT 2+4WD 2DR "Climber" Cat-Back™ "S-Type"
140634	12-16 Wrangler 3.6L V6 AT/MT 2+4WD 4DR "Climber" Cat-Back™ "S-Type"
11818	12-16 Wrangler 3.6L V6 AT/MT 4WD 2+2DR Rear Section "S-Type"

Part No.	Application
17251	07-11 Jeep [®] Wrangler
17202	00-06 Jeep [®] Wrangler 4.0L 6cyl. 4WD AT/MT
17062	88-90 Jeep [®] Wrangler 4.2L MT
17236	98-99 Jeep [®] Wrangler 4.0L 6cyl. 4WD AT/MT
17053	81-86 CJ-7 4.2L w/o Air Tubes MT 2/4WD

Stainless Steel Intercooled Exhaust Tips

Borla's stainless steel exhaust tips have cooling fins around the inside pipe to condense exhaust gases, reduce backpressure, and mellow out your exhaust tone.

Part No. 20106



Part No. 20213



Part No. 20233



Part No. 20104



OFF CAMBER FABRICATIONS

BY MBRP

Off Camber Fabrications Exhaust Systems

We designed a brand new muffler for the JK that draws out every bit of available power. It keeps a civilized rumble on the streets but once it's unleashed, hear it roar. We then created a muffler relocate system that pushes the muffler ahead of the axle and out of harm's way. Products that Jeep[®] owner's want- that's MBRP's commitment to leadership through innovation.

Part No.	Application
S5530409	12-16 3.6L Stainless; Off-Road System
S5530BLK	12-16 3.6L Black; Aluminized Off-Road System
S5514BLK	07-11 3.8L 4 Dr. Black; Muffler Before Axle Off-Road System





Cat-Back Exhaust System

- Straight through nonrestrictive system design maximizes airflow, improving performance and fuel economy
- Patented RSC™ technology allows us to acoustically style the sound of your vehicle to give you the true voice of performance without the annoying drone while cruising
- All components, even clamps and hangers, of the system are constructed of premium grade, 304 stainless steel
- No welding needed. All hardware and detailed instructions are included
- Easy bolt-on installation



Part No	Black Part No.	Application
14466	14466BLK	12-15 Grand Cherokee (SRT/SRT8) 6.4L V8 Sport 2.75" Cat-Back DRE Single 4.5"
14457	14457BLK	11-15 Grand Cherokee (Exc. Summit) 5.7L V8 Sport 2.5" Cat-Back DRE Single 4.0"
24412	—	07-15 Wrangler JK 3.8L/3.6L V6 Sport 2.5" Axle-Back DRE Single 3.5"



Cat-Back Dual Exhaust for JK 07-15 (2/4 Door)

Because Jeep® enthusiasts need more power from idle to 3,000 RPM, Gibson designed their Jeep® exhaust to enhance low and mid range performance for climbing and towing. This Split Rear Exhaust exits straight out the back, with Dual Large diameter Tip. Hassle free, bolt-on installation with professional results.

- 2.50" Mandrel bent tubing
- Baffled and chambered muffler, no internal packing, powerful deep tone
- 3.50" Polished T304 stainless round slash-cut tip
- Bolt on installation with all hardware
- Lifetime limited warranty

Part No.	Description
600023	Metal Mulisha, Black with 5" Tip
617303	Stainless
17303B	Black Ceramic



Performance Headers

Dyno-tuned and engineered to deliver more usable horsepower and torque at low and mid-range RPM highway speeds. Improves engine's ability to breathe and cooler operating engine temperature. Designed as a direct replacement for the factory manifolds, using the stock crossover pipe.



Chrome Part No.	Stainless Part No.	Application
—	GP400S	91-99 Cherokee 4.0L 2/4WD 1-1/2"
GP403	GP403S	Wrangler 07-11 3.8L 1-1/2"



Evolution Competition System For Off-Road Use Only

- "Stainless steel Ultra Flo™ polished muffler
- 2-1/2" mandrel bent stainless steel tubing
- Exhaust exits before rear axle



Part No. 39522 - 12-15 Wrangler Unlimited 3.6L V6



JK "Rockcrawler" System

- Stainless steel Ultra Flo™ Polished Muffler
- High clearance off-road "Rockcrawler" design
- 3" outlet, single wall, buffed and polished, 6" OAL SS slant cut tip
- 2-1/2" Mandrel bent stainless steel tubing

Part No. 39523 - 12-15 Wrangler 4 Door 3.6L V6



Monster Exhaust Systems

Constructed entirely of heavy-gauge stainless steel, Banks Monster features a supersized, 2.5-inch tailpipe with a stainless tailpipe tip polished to a mirror finish. Monster Muffler, Banks' straight-through performance muffler, is the industry's least restrictive, more than doubling the stock flow. Monster virtually eliminates backpressure from the catalytic converter back, for more power and efficiency—and an authoritative, yet civil, exhaust note.



Part No.	Application
51342	12-15 Wrangler 3.6L 2 DR
51343	12-15 Wrangler 3.6L 4 DR
51321	07-11 Wrangler 3.8L 2 DR
51322	07-11 Wrangler 3.8L 4 DR
51314	04-06 Wrangler 4.0L
51315	04-06 Wrangler Unlimited 4.0L



Force II Cat-Back Exhaust

These systems are for the person who wants a subdued but custom look with all the benefits of a Flowmaster exhaust system. They feature mandrel bent 16 Gauge aluminized steel tubing, either weld-on or flanged inlet pipe/pipes, specially tuned muffler, clamps, hangers and stainless steel exhaust tip.

Part No. 817711 - 14-16 Jeep® Cherokee with 3.2L Engine

Part No. 817437 - 07-11 Wrangler JK Axle-Back 2-1/2"

Part No. 817738 - 07-11 Wrangler Axle-Back 2-1/2"

50 Series SUV Performance Mufflers

- Aluminized steel
- Special tuning chamber
- Mellow deep tone
- Mild interior resonance
- Larger case for improved sound control



Part No. 52457 - 84-98 Jeep® Grand Cherokee, 4.0, 2-1/4" I.D.

Part No. 52557 - 84-98 Jeep® Grand Cherokee, 4.0, 2-1/4" I.D.



TFX Performance Kat-Back Systems

TFX Performance Kat-Back Systems feature computer-designed fully welded mufflers and stainless steel tips. They use mandrel-bent, 2-1/2" diameter, 16-gauge aluminized steel tubing and fully aluminized mufflers that deliver a deep, powerful sound. All TFX Performance Kat-Back Systems mount using the stock hangers and mounting points. All hardware included.

Part No.	Application
862876	04-06 Wrangler TJ Unlimited
862872	91-95 Wrangler YJ
862878	07-10 Wrangler Unlimited (4 Dr.)



Jeep® Headers

- 50-State Legal
- Mandrel-bent 16-gauge tubing
- Thick, port-matched CNC-machined flanges
- ARMOR® Coat metallic ceramic finish available



Part No.	Application
701128	87-90 Jeep® Wrangler, 4.2L
701129	91-99 Jeep® Wrangler, 4.0L
701133	00-06 Jeep® Wrangler, All, 4.0L **
701137	91-95 Wrangler, 2.5L

** C.A.R.B. E.O.# pending



American Thunder Cat-Back Exhaust With Improved Off-Road Clearance

This 2-1/2" system features a 409S stainless steel mandrel bent tailpipe with a 3" polished stainless steel tip and fits both 2 and 4 door models with the 3.6L and 3.8L V6 engines. This system replaces the factory transverse muffler and relocates the Super HP-2 muffler behind the factory catalytic converter, providing a moderate to aggressive sound level. This relocation allows for better ground clearance when driving off-road. Because the tailpipe is tucked up so high, an aftermarket metal bumper is recommended.

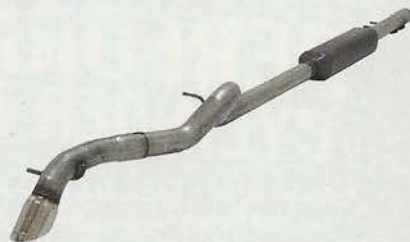

- Stainless steel construction
- Provides maximum off-road clearance
- Patented laminar flow technology
- Lifetime limited warranty

Part No. 817674 - 07-15 Jeep® Wrangler 2Dr/4Dr with 3.6L or 3.8L



Red Pack Glasspack Mufflers

- High temp red coating
- Dyno proven
- Anti-corrosive aluminized body
- Straight-through performance design
- Traditional glasspack sound
- Sound of horsepower from idle to full throttle
- Loose fiber acoustic packing material for cost effective performance



Part No.	Body Size	Inlet/Outlet	Body length	Overall Length
13124	3.5" Round	2"/2"	18"	22"
13125	3.5" Round	2.25"/2-1/4"	18"	22"
13129	4" Round	3"/3"	18"	22"
13134	3.5" Round	2"/2"	22"	26"
13135	3.5" Round	2.25"/2-1/4"	22"	26"
13144	3.5" Round	2"/2"	26"	30"
13145	3.5" Round	2.25"/2-1/4"	26"	30"
13146	4" Round	2.5"/2-1/2"	26"	30"



Mufflers



- Rich, powerful sound
- 3-1/2" diameter 16-ga. case
- Spiral louver design core
- Decreases backpressure
- Distinctive purple finish



Part No.	Description	Unit	"A"	"B"	"C"	"D"
50225	1 Slip-Fit Muffler	1	2-1/4"	2-1/4"	18"	24"
50230	2 3" 3 Hole Header Muffler	1	3"-3 Hole	2-1/4"	18"	24"
50231	3 13" 3 Hole Turn-Out Header Muffler	1	3"-3 Hole	3"	29"	32"
50232	4 3" 3 Hole Jeep® Header Muffler	2	3"-3 Hole	3"	29"	32"

Unit: 1 = Each, 2 = Pair

NEW! PERFORMER JEEP 4.0L CYLINDER HEAD

- Designed as a bolt-on performance upgrade for 1987-2006 Jeeps with a 4.0L inline six cylinder engine
- Features all-new better flowing intake/exhaust ports along with a modern combustion chamber design and backcut and swirl polished valves
- Retains the stock valve angle, pushrod length and valve cover rail height for use with factory components and off the shelf accessories
- Includes reinforced rocker bosses for improved strength at high RPM and Heli-Coil® threaded inserts in the manifold bolt holes for added strength
- Cast with 3/4" deck throughout and is machined to accept either distributor or coil pack ignition



Part No. 50169 - Wrangler 4.0L
Inline Six, Complete single
Part No. 50159 - Wrangler 4.0L
Inline Six, Bare single

**HEART-SHAPED
CHAMBERS**

JEEP WRANGLER SUPERCHARGER



- Available for 2012-14 Jeep Wrangler
- E-Force supercharger systems deliver the best combination of towing power and daily drivability
- Features Eaton® internals for reliability and a unique air flow design that produces excellent torque
- Includes a tune is optimized for various towing conditions to deliver peak performance when its needed
- Self-contained oil system with 100,000 mile service interval (no drilling or plumbing required)
- E-Force superchargers are backed with a free 3 year, 36,000 mile limited powertrain warranty
- 50-state legal

Part No. 1527 - 12-14 Jeep
Wrangler 3.6L, with tuner



© Eaton and TVS are registered trademarks of Eaton Incorporated

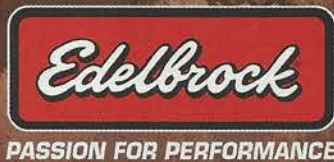

© 2015 Edelbrock LLC



Tire Pressure

There are few things that affect the performance of your vehicle as much as your tire pressure. Unparalleled accuracy and durability. A durable carrying case is included with each gauge.

Part No.	Description
2343	60 Psi Mechanical Handheld
2160	60 Psi Mechanical W Case



Officially Licensed Jeep® Products



3 3/8"	Part No.	Description
		In-Dash Speedometer
	880245	120 Mph In-Dash/ Mechanical
	880244	160 Mph In-Dash/ Electric

3 3/8"	Part No.	Description
	880246	In-Dash Tachometer 8,000 Rpm

Short Sweep Electric

2 1/16"	Part No.	Gauges	Range
	880431	Axle Temperature	100°-250° F
	880428	Fuel Level	(73 Ω Empty/10 Ω Full)
	880243	Fuel Level	(0 Ω Empty/90 Ω Full)
	880240	Oil Pressure	0-100 Psi
	880429	Oil Temperature	100°-250° F
	880430	Transfer Case Temperature	100°-250° F
	880260	Transmission Temperature	100°-250° F
	880242	Voltmeter	8-18 Volts
	880241	Water Temperature	100°-250° F

Gauge Pods **Auto Meter GAUGE WORKS**

Direct fit mounting solutions provide a factory level of fit and finish to your specific application. These mounting solutions are engineered to place the gauges in the driver's line of sight and are built to withstand the vigor of racing or anything you can throw at them on the street.



Part No. 5381



Part No. 5380



Part No. 15222

Part No.	Jeep® Pod
5380	Jeep® JK 07-10

Single	Dual	Jeep® Pillar
Part No. 13118	Part No. 15221	Jeep® JK 07-10
13119	15222	Jeep® JK 11-14



Part No. 15219

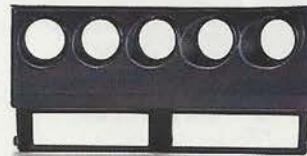

Part No. 15218

Part No.	Jeep® Dash Panel
5381	Jeep® TJDirect Fit 2 - 3 3/8" Holes and 4 - 2-1/16" Holes 97-05 Wrangler T.J. or two 2 1/16" gauges, space for switches
15219	Jeep® YJ 87-95 5 - 2 1/16" Holes
15218	Jeep® YJ 87-95 2 - 3 3/8" Holes
15220	Jeep® YJ 87-95 2 - 3 3/8" Holes



Part No. 15221



Trail Rocker

Introducing the Trail Rocker from Painless, allowing you to control up to eight accessories on your JK. The heart of this kit is enclosed in the weatherproof housing that surrounds the power center with eight fuses and relays. Controlling it, are five prewired switches mounted in our custom dash panel for a clean factory installed look inside your Jeep®. The power center then provides you with all the necessary weatherproof connectors and wiring to connect to your Jeep® accessories ranging from lights to air lockers.

- Weatherproof housing around the power center and connections
- Custom bolt-on powder coated bracket for the power center
- Switch panel mounts 5 LED switches in a factory non-intrusive dash location

Part No. 57000 - 11-16 Jeep® Wrangler JK, Black
Part No. 57001 - 11-16 Jeep® Wrangler JK, Tan
Part No. 57002 - 07-10 Jeep® Wrangler JK, Black
(Automatic Transmission Applications Only)



PowerBraid® Split Braided Sleeving

Protect and clean up any harness installation with this braided wire wrap. Laterally split design closes around wire bundle without the need for additional taping or zip ties. 25% edge overlap allows for easy installation over splices and inline connectors without exposing wires and cables.

Part No.	Description
70901	1/4", 20'
70902	1/2", 10'
70903	3/4", 6'
70904	2", 4'

MORE
Mountain Off-Road Enterprises

NEW



Dual Battery Tray

Will accommodate 2 Optima series 34 and 34/78 or the OEM batteries side by side in the stock location. This easy bolt-in kit bolts into existing holes comes powder coated black and retains OEM air filter box.

Part No. JKDBT12 - 12+ Wrangler JK.

TAYLOR
TAYLOR CABLE PRODUCTS, INC.

Trunk Mount Battery Relocation Kits A Must For The Serious Off-Roader!

- Provides better weight distribution
- Reduces engine compartment clutter
- Better traction
- Fits most cars and up to Group 27 batteries
- Kits Include:
 - Heavy-duty, 2-gauge, 100% solid copper cable
 - Brass battery terminals
 - All necessary hardware

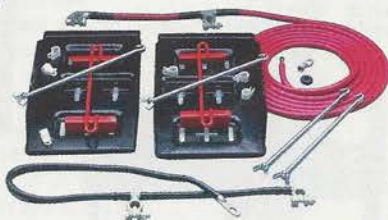

Part No. 48000 - Single Battery Kit

Part No. 48020 - Single Kit w/1ga. Welding Cable

Part No. 48500 - Dual Kit/Side by Side

OPTIMA[®]
BATTERIES
THE ULTIMATE POWER SOURCE

The Optima Battery

- Spiral cell design protects it from heat and vibration
- If battery is damaged, it will not leak and will continue to work
- Delivers more dependable starts in extreme weather
- High starting capacity

Part No. 3478 - 800 CCA - 104 Minutes

- Faster and a more efficient recharge
- Delivers more power quickly during peak demand
- Consistent voltage throughout delivery

Part No. D3478 - 650 CCA - 120 Minutes



DENSO

Iridium Power Spark Plugs

- Iridium is a metal that is 6 times harder, 8 times stronger, and is capable of withstanding temperatures 1,200°F hotter than platinum
- Ultra-fine 0.4mm diameter iridium electrode
- Tapered U-Groove ground electrode
- Requires less voltage from the ignition and increases acceleration by 2%

Part No.	Application
5303	99-04 Grand Cherokee V-8 4.7L
5304	02-04 Grand Cherokee Overland V-8 4.7L
5303	96-98 Grand Cherokee Laredo/Limited V-8 5.2L
5302	88-90 Cherokee 4.0L
5304	02-04 Liberty 3.7L
5338	02-04 Liberty 2.4L
5303	02-06 Wrangler 4.0L
5338	03-06 Wrangler 2.4L
5349	07-11 Wrangler 3.8L



More applications available.

POWERMASTER
Performance

XS Torque Starters

- 4.4:1 Gear reduction
- No heat soak problems
- Recommended for 18:1 Compression
- Machined aluminum adapter block
- Clears MOST oil pans and headers
- Very high efficiency rating
- Weighs 8.5 lbs



Natural

Part No. Application

9515 All models to 1987 exc. 4.0L engine

9516 91-06 Jeep Wrangler 87-04 Cherokee

9416 88-04 4.0L

Hi-Amp Alternators

- Smooth die-cast housing with teardrop design
- Smooth back with special Powermaster vents for pull-through cooling
- Gold battery post
- Proof of performance tags



Chrome Part No.	Natural Part No.	Black Part No.	Polished Part No.	Amps	Application
—	43311	53311	63311	170/110	91-01 Wrangler
17294	—	—	27294	100/70	83-90 Wrangler
37294	47294	57294	67294	140/80	83-90 Wrangler
17127	—	—	—	70/40	78-80 Wrangler/CJ
17294	8002	—	27294	100/70	78-80 Wrangler/CJ



BOSCH

Platinum+4

Four ground electrodes, the most platinum and the most powerful spark

- Bosch Platinum+4 has the most platinum and delivers smoother acceleration, top fuel economy and ultimate engine performance
- Revolutionary Surface Air Gap Firing Technology using four yttrium enhanced electrodes delivers a longer, more powerful spark for the most efficient combustion, plus a longer performance life
- Never Requires Gapping—the electrode gap is factory-set and never requires adjustment



Platinum Plus

Bosch exclusive platinum technology for premium performance

- Bosch Platinum Plus combines a platinum center electrode, plus a tapered, yttrium-enhanced ground electrode for quicker starts, smoother acceleration, increased fuel efficiency, and a 25% longer performance life
- Lower Ignition Voltage Requirement—reliable starting and a more reliable spark without misfires
- Factory Set Gap—once the proper gap is set, there's no need to re-gap





Blaster High Vibration Coil

This coil is the best for harsh conditions. The sturdy metal housing of the High Vibration Coil is potted with premium-grade two-part epoxy to completely encase the coils' primary and secondary windings, protecting the coils internal components from vibrations encountered in harsh racing conditions.

C.A.R.B. Approved: E.O. D-40-15

Part No. 8222



MSD-BLASTER 2 High Energy Coil

High-quality, high-energy coil for use with all MSD Ignition Controls from street to track, off-road to marine. Alkyd top provides greater insulation for the higher voltages generated by the increased turns ratio.

C.A.R.B. Approved: E.O. D-40-27



Part No.	Description
8200*	Chrome Universal Coil
8202*	For MSD Ignitions
8203*	Universal Coil
8223	Blaster 3, extra tall tower design

*Includes ballast resistor

Pro-Billet Distributors

- Easy-to-adjust mechanical advance with supplied springs and stop bushings
- Vacuum advance canister for improved economy (can be locked out)
- CNC-machined billet aluminum housing and billet aluminum base
- Polished steel shaft is QPQ coated and guided by a sealed ball bearing
- Advance plate and weights are fine blanked from chrome moly steel and QPQ coated for friction reduction
- Supplied with a socket style distributor cap and rotor
- Must be used with an MSD Ignition Control
- CARB E.O. Approved

Part No. 8516 - AMC/Jeep® 232-258 4.0L

Part No. 8519 - AMC/Jeep® 290, 304, 343, 360, 390, 401



Super Conductor Spark Plug Wires

The MSD 8.5 Millimeter Super Conductor® is the ultimate performance wire. The super conductor uses a copper alloy conductor resulting in less than 50 Ohms per Foot of wire. This ensures that the most energy possible makes it to the spark plug. Cap off each end with our dual crimp terminals and you have the best wire available.

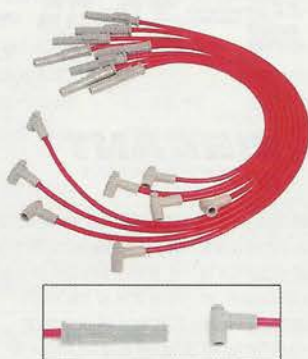

Part No. 32239 - 91-95 Wrangler, 97-98 Wrangler



Flame-Thrower

Performance Coils

- Better fuel economy
- More horsepower
- Smoother running
- Quicker starts



While it's the perfect coil to go with the PerTronix Ignitor breakerless ignition, our 40,000 Volt Flame-Thrower canister coil can benefit virtually any distributor type inductive system. Its higher Voltage allows larger spark plug gaps for added power, smoother response and better fuel economy. These coils are internally resisted so installation and wiring is drastically simplified.

Chrome Part No.	Black Part No.	Flame-Thrower 40,000 Volt Coils (Recommended for Ignitor Equipped Applications)
40001	40011	1.5 ohm oil filled canister coil
40501	40511	3.0 ohm oil filled canister coil
—	40111	1.5 ohm epoxy high vibration coil
—	40611	3.0 ohm epoxy high vibration coil



SuperStock 8mm Spiral Core Wire Sets

- 550°F-rated
- Street-driven applications
- 8mm red high-temperature silicone jacket resists moisture, chemicals, and severe temperatures
- High-strength fiberglass braid for added "pull strength" silicone insulation eliminates arcing
- Stainless steel plug terminals for high electrical conductivity and corrosion resistance

Part No. 5133R - 91-00 Wrangler 2.5L 4-cyl. engine

Part No. 5129R - 91-99 Wrangler 4.0L 6-cyl. engine



Chrysler Super Coil

- Rated at 42,000 volts at 1.0 ohms resistance
- Direct bolt-in install
- Quicker starts, improved idle, crisp throttle response and higher top RPM power

Part No. 140021 - Jeep® 2.4L and 4.0L engines



Black Magic X-Treme Fan

All-new, bigger, and more powerful than any other single fan on the market. Most radiators are rectangular, not square. To get the most out of any type of fan, it's best to cover as much of the radiator core as possible. Flex-a-lite designed a high-performance electric fan that does exactly that.



Part No. 485
87-05 Jeep® Wrangler 4/6 cyl

Mojave Heaters

The Mojave heater **Part No. 640** is designed to add heat and comfort to your ride. Its design offers many mounting options and an optional plenum sold separately **Part No. 650** includes adjustable louvers and a flange for defroster ducting.

Part No. 655 includes adjustable louvers. Lower profile design for installation in tight spaces.



Electric Fan Relays With Thermostatic Switch

This Fan-Thom II kit comes with a threaded thermostat that screws into the engine block or intake manifold for a professional-looking installation. This is inexpensive protection for an electric fan and a vehicle's wire harness. Provides constant voltage, protects from voltage and amperage spikes, and prevents the fan from back feeding voltage through the vehicle's wire harness.

Part No. 30102 - Fan Relay Kit, 200° on/185° off thermostat
Part No. 30103 - Fan Relay Kit, 185° on/170° off thermostat



High Performance Waterless Engine Coolant

- Boiling point: Above 375° Fahrenheit
- Protects below -40° Fahrenheit
- Reduces system pressure, prevents overheating, maximizes brake horsepower
- Eliminates corrosion and erosion
- Protects for life
- Non-toxic

Part No. EC53001 - 1 Gallon Jug



Jeep® Cooling Performance Radiators

- Full aluminum construction including durable, TIG-welded end tanks
- Features a two-row, 1.97" thick, efficient brazed aluminum core
- Increases fluid capacity by .36 gal
- Provides a proven 20% improvement in fluid cooling efficiency, ideal for use on the street or trails
- Engineered for use in both stock and highly modified vehicles
- Includes 1.3 Bar high-pressure radiator cap and magnetic drain plug

Part No.	Application
MMRADWRA87	87-06 Wrangler 2.5L 4.0L
MMRADWRA07	07-14 Wrangler

Racing Thermostat

- Low activation temperature than stock jeep wrangler thermostat allows coolant to flow through the system earlier
- Reduces and maintains lower engine coolant temperatures
- Ideal for vehicles in warm climates or under extreme towing/driving conditions
- Utilizes high-quality wax for reliable, repeatable operation

Part No. MMTSWRA12 - 11-15 Wrangler 3.6L



Jeep® Wrangler Performance Electric Fan Kit



- Replaces fan clutch, fan shroud and new shroud mounts to factory locations
- Complete kit
- Radiator reservoir remount brackets included
- Aluminum shroud
- Thermostatic control included
- A/C override circuit included

Part No. 20161

Direct Fit Jeep® Mission Cooler Kit



- Reduces fluid temperatures 30-40° F
- Perfect for rock crawling and off-road use when airflow is limited
- Complete kit includes
- Dramatically increases transmission life
- Thermostatically controlled 500 CFM electric fan for optimal cooling
- Mounts to frame rail with no drilling

Part No. 20561



Fittings

Vibrant performance offers a vast line of aluminum and steel fluid transfer fittings! Whether it's an oil, water, coolant or fuel application, we have one of the most comprehensive offerings of precision manufactured adapter and reusable an fittings to address all of your project needs.

20000 Series





Avenger Carburetors

The off-road Truck Avenger is designed specifically for off-road applications. The unique, fuel-metering block eliminates fuel spillover through the boosters at extreme angles allowing for 40° climbing, 30° side hill maneuvers and nose-down descents to avoid hesitations, stalling, and flooding typically associated with carbs in an off-road environment. The 470 cfm off-road Truck Avenger is the perfect carburetor for 4 cylinder, V-6, and inline 6 cylinder engines.

Part No. 090470 - 470 CFM

Part No. 090670 - 670 CFM

Street Performance 2-Barrel Carburetor

- Manual choke
- 50cc accelerator pump
- 1 timed (spark) port, 1 full vacuum, and 1 PCV port
- Intended as stock performance replacement for 2-bbl street applications. Also mandated carbs for some oval track racing sanctioning bodies
- Ford A/T kickdown, does not work with A.O.D. transmissions

4-Barrel Street Carburetor

- Vacuum secondaries allow use on wide variety of vehicles
- Electric choke for easy warm up
- Single feed fuel inlet
- 1 timed (spark) port, 1 full vacuum, and 1 PCV port
- Intended for small V-8 or 6 cyl. engines and 2 x 4 street tunnel ram set-ups
- Ford A/T kickdown, does not work with A.O.D. transmissions

Electric Fuel Pumps

- Tumble polished billet look
- New lower housing casting for enhanced fuel flow and quieter operation
- Improved design for street/strip applications
- Not designed or recommended for use with fuel injection systems

Part No. 128011 - Street Perf. - 97GPH free flow, 71GPH at 4PSI

Part No. 128021 - Comp. Perf. - 110GPH free flow, 88GPH at 9PSI, (Regulator Incl.)

Part No. 12803 - Fuel Pres. Regulator - 4.5-9 PSI, Standard

Part No. 128151 - 14 PSI, 140 GPH



High Flow E85 and Gasoline Fuel Pumps

- AEM's High Flow in-tank and inline
- Fuel Pumps are designed for high performance naturally aspirated and forced induction EFI vehicles.
- In-tank high flow fuel pumps
- In-tank pumps flow up to 320 lph (84 gph) at 43 PSI and are capable of supporting over 1,000 HP at 43 PSI



Part No.	Application
501000	320 lph High Flow In-Tank Fuel Pump (Offset Inlet, Inline)
501200	320 lph E-85 Compatible In-Tank Fuel Pump (Offset Inlet, Inline)
501205	320 lph E-85 Compatible In-Tank Fuel Pump (Center Inlet)
501210	310 lph E-85 Compatible In-Tank Fuel Pump (Short Offset Inlet, Inline)
501215	320 lph E-85 Compatible In-Tank Fuel Pump (65mm Short Offset Inlet with Hooks, Inline)
501220	320 lph E-85 Compatible In-Tank Fuel Pump (65mm Short Offset Inlet without Hooks, Inline)

Jeep® is a registered trademark of FCA US LLC. More Applications Available.



Oil Filter Relocation Kit



- Allows you to relocate your oil filter where you want it
- Each kit includes an oil filter bypass adapter, a single or dual remote filter base, a 30" hose kit, all fittings, hardware, and complete installation instructions

Part No. 1113 - 91-01 Jeep® Cherokee w/ PH16 Filter

Part No. 1156 - Compact replacement oil filter



High Energy Cams

- Work well with mainly stock components (rockers, manifolds, heads, compression, converters, gears)
- Good blend of efficiency and performance
- Perfect choice for performance rebuilds
- Great choice for engines where performance upgrades are not planned

AMC/Jeep® 199-258, 4.0L

Part No. 682004 - 252H, excellent torque, throttle response, smooth idle

Part No. 682014 - 260H, great for towing, 4wd and off-road, smooth idle

Part No. 82212 - High-energy hydraulic lifters

Part No. 92612 - Single outer valve springs w/damper, 1.476"



Motor and Transmission Mounts

- Re-engineered to handle higher horsepower and torque
- Outlasts rubber mounts by a wide margin
- Made of HYPER-FLEX™ performance polyurethane

97-06 Jeep® Wrangler Transmission Mount

Part No. 21103G - Black

Part No. 21103R - Red

87-06 Jeep® Wrangler 6 Cyl. Motor Mount

Part No. 21104G - Black

Part No. 21104R - Red

72-86 Jeep® CJ Motor Mounts

Part No. 21102G - Black

Part No. 21102R - Red



Repair Manuals

The only books available based on a complete tear down and rebuild of a vehicle.

Part No.	Application
50035	02-07 Jeep® Liberty
50020	49-86 Jeep® CJ
50030	87-11 Jeep® Wrangler
50026	05-09 Jeep® Grand Cherokee
50025	93-04 Jeep® Grand Cherokee
50010	84-01 Jeep® Cherokee



TERAFLEX NEW

JK Big Brake Kit

The TeraFlex JK Front big brake kit is designed as a factory brake upgrade for JK owners looking for a performance brake package that will handle the increased braking requirements needed after larger wheels and tires are used. The simple bolt-on upgrade installation requires no cutting, welding or adapter bracketry. The big brake kit features oversized 56mm dual piston calipers for increased clamping force and surface area. The 13.3" Mill-balanced vented slotted rotor provides greater braking leverage to allow stopping distance to be decreased substantially and decreases heat buildup. The Composite-resin, semi-metallic pads have excellent cold stopping power resulting in maximum initial speed scrub, increase pad life and reduce noise & dust. **Note: A minimum of 17" diameter wheels must be run with the big brake kit.**



Part No. 4303420 - 07-16 Wrangler

POWERSTOP

1-Click Brake Kits

- Fast, easy and affordable solution for better braking
- Offers more pad bite without noise and dust
- Silver zinc plated cross-drilled and slotted rotors are reverse engineered from oem samples
- Carbon fiber infused Evolution™ ceramic formula for superior braking power
- Pad surfaces are thermal scorched for a fast break-in
- Premium rubberized shims provides virtually noise-free braking



Part No. K279836 - 07-15 Wrangler Z36 Extreme Carbon Fiber Ceramic Brake Pads
Part No. K2798 - 07-15 Wrangler Carbon Fiber Ceramic Brake Pads

MGP CALIPER COVERS

- Enhance your wheel appearance
- Protects wheels from brake dust
- Easy installation, fewer than 10 minutes!
- 6061-T6 aerospace aluminum
- Bridge union is TIG welded for strength
- CNC precision engraving for customization
- Hydraulically formed to fit each caliper
- Powder-coating and custom paint match



Part No.	Application
42007SPJ11	07-15 Wrangler - No Logo, Camo V1 Style
42007SPJ12	07-15 Wrangler - No Logo, Camo V2 Style
4173SSILC2	07-15 Wrangler - Jeep® Logo/ Rear Jeep® Grill Logo, Forest Camo
4173SMGPC2	07-15 Wrangler - Jeep® Logo, Forest Camo
5001SHEMC2	07-15 Wrangler - Wrangler Logo, Forest Camo
42007SMOPM	07-15 Wrangler - Mopar Logo, Matte Black
42007SMOPR	07-15 Wrangler - Mopar Logo, Red
42007SMOPB	07-15 Wrangler - Mopar Logo Black
42007SWRGB	07-15 Wrangler - Black
42007SWRGM	07-15 Wrangler - Matte Black
42006SJPLR	11-15 Grand Cherokee - Red
42010SJPEM	14-15 Cherokee - Matte Black
42012SMOPB	14-15 Jeep® Cherokee - Mopar Logo, Black



Before



After

Rear Disc Brake Conversion

The TeraFlex disc brake kit is ideal for anyone wanting to upgrade a quality disc brake package to their axles. This disc brake kit is intended for use as a bolt-on upgrade to replace factory Jeep® drum brakes. The internal drum parking brake provides outstanding holding power when compared to other disc brake conversion kits. Fits all Jeep® factory rear axles from 1991 through 2006, including the Dana 35 c-clip, Dana 44 and Chrysler 8.25. Emergency brake cables are sold separately.



Part No. 4354420 - 91-95 Wrangler, 97-06 Wrangler

Brake Line Kits

TeraFlex DOT approved stainless steel braided brake lines are designed for JK applications. These stainless line kits will prevent line expansion, thereby giving a much firmer-feeling pedal. All brake lines measure longer than stock for additional brake line length. All stainless brake lines are made to MVSS-1006 specifications.

Part No.	Application
4353310	07-16 Wrangler 26" Front Kit
4350310	07-16 Wrangler 30" Rear Kit

EBC BRAKES

Yellowstuff Brake Pads

Yellowstuff is especially appreciated for towing and heavy loads and where wheel and tire oversize upgrades have been fitted. Yellowstuff is not rated as low dust and creates similar dust to OEM pads. Drivers love it because normally race pads require warm up but not the EBC Yellowstuff. This compound works well from cold and is therefore a perfect solution if you simply want the best stopping power you can get for street use on a Jeep® where the brakes are "Marginal" from the factory or you have enhanced your ride with oversize wheels tires or raised suspension.



Part No.	Application
DP41799R	07-13 Wrangler; Rear
DP41798R	07-13 Wrangler; Front
DP41255R	97-06 Wrangler; Front

HPS Ferro-Carbon Brake Pads



- Extremely low dust
- High friction/torque hot or cold
- Gentle on rotors, long pad life
- Virtually noise-free



LTS Light Truck and SUV Brake Pads

- Improved braking over OE
- Excellent pad and rotor life
- Superior fade resistance



Front Part No.	Rear Part No.	Application
HB558_710	HB555_678	05-10 Grand Cherokee
HB569_650	—	07-14 Wrangler/Liberty
HB210_677	—	90-01 Cherokee, Sportwagon - Mid-Size XJ Series
HB210_677	—	95-98 Grand Cherokee
HB210_677	—	93-94 Grand Cherokee - Rear Disc, From VIN #358322
HB210_677	HB285_595	93-94 Grand Cherokee - Rear Disc, To VIN #358321
HB210_677	—	93-94 Grand Cherokee - Rear Drum Brakes

To order, insert an "F" for HPS or "Y" for LTS in the blank space in the part number. Some applications are available by special order only.



Axle Truss Kits
For Stock JK Dana 30 or 44

Part No.	Application
672051JKF	Metric housing stock caster 0" - 4" lift - front
672051JKFL	Metric housing stock caster 4" - up lift - front
672051JKFS	SAE housing stock caster 0" - 4" lift - front
672051JKFSL	SAE housing added caster 4" - up lift - front
672052JKR	Metric housing rear
672052JKRS	SAE housing rear

Offering Complete Axle Assemblies And Components

Ring and Pinions

Key Features



- Forged 8620 Steel – For strength and reliability
- Precision machined – To offer consistent installation
- Heat treated – Offers durability
- Lapped – For smooth and quiet operation
- Available for all popular applications

AMC 20 Ratio		
3.31	3.54	3.73
4.10	4.56	4.88

Dana 30 Standard Ratio			
3.73	4.10	4.56	4.88

Dana 30 Reverse Ratio			
3.54	3.73	4.10	4.56
4.88			

Dana 30 JK Ratio	
4.88	5.13

Dana 35 Ratio			
3.73	4.10	4.56	4.88

Dana 30 TJ Ratio		
3.55	3.73	4.10
4.56	4.88	

Dana 44 Rubicon Ratio		
4.56	4.88	5.13

Dana 44 JK Ratio	
Front	Rear
4.88	4.88
5.13	5.13
5.38	5.38

Dana 44 Ratio		
3.54	3.73	3.92
4.09	4.27	4.55
4.89	5.13	5.38
5.89		

TERAFLEX

HD Differential Cover

TeraFlex heavy duty differential covers are designed to offer extreme protection from rocks, obstacles and other debris on the trail. The cover is cast from the same high-strength ductile-iron as our HD axle housings. The cover is over 3/8" thick to ensure protection



Part No.	Description
3990660	Dana 60
3990630	Dana 30
3990650	Dana 44



4X4 ACCESSORIES

Off-Road Differential Cover

When off road, it is inevitable that obstacles and off road hazards will be encountered that could potentially inflict expensive damage to your differential. To prevent this, ARB manufactures the differential cover. Using high tensile nodular iron, it has been engineered to protect the differential and ring and pinion set from any off road hazards.



Part No. 0750004 - Dana 35
**Dana 60 shown*



Machined Differential Cover

- Constructed out of heavy-duty, durable, nodular iron
- Dual neodymium magnetic plugs are used for maximum gear protection
- A 1/8" NPT calibration plug set to the factory fluid level for easier/quicker filling
- Machined groove to accept supplied O-ring for a leak free seal



Part No. 4670162 - 12 Bolt, 9-3/4" Rear
Part No. 4670166 - Dana 44, 12 Bolt
Part No. 4670192 - Dana 30, 10 Bolt



Differential Cover



- 10 Bolt
 - With drain plug
 - Chrome, steel
- 9238 - DANA 30



Boulder Differential Cover



- Constructed from A356-T6 cast aluminum for strong impact resistance
- Features a precision machined sealing surface, allowing gaskets or RTV sealant to be used for a leak-free seal

Part No. 1659512 - Dana 44, 10 Bolt
Part No. 1659513 - Dana 30, 10 Bolt



Air Locker

- Provides 100% traction on demand without affecting on road drivability or driveline wear
- Easy, convenient operation allows the user to concentrate on the terrain without leaving the comfort and safety of the driver's seat
- Ultra durable and extremely strong - only the highest quality materials used in construction
- Requires a Differential Locker



Part No.	Locker	Application
RD100	DANA 30; 29.5 (1.16") Shaft; 27 Spline; 3.73 & UP Ratio	Front 07-15 Jeep® Wrangler JK 2-4 Door 97-06 Wrangler TJ/Unlimited
RD101	DANA 44 - RUBICON ONLY; 29.5 (1.16") Shaft; 27 Spline; 3.54 & DN Ratio	Front 07-15 Jeep® Wrangler JK 2-4 Door 97-06 Wrangler TJ/Unlimited
RD157 ^{2,3,4}	DANA 44; 38.1 (1.50") Shaft; 35 Spline; ALL4 Ratio	Rear 07-15 Jeep® Wrangler JK 2 Door
RD147 ^{1,2}	DANA 44; 38.1 (1.50") Shaft; 35 Spline; ALL5 Ratio	Rear 07-15 Jeep® Wrangler JK 2 Door
RD157 ^{2,3,4}	DANA 44 - RUBICON ONLY; 38.1 (1.50") Shaft; 5 Spline; ALL4,5 Ratio	Rear 07-15 Jeep® Wrangler JK 2 Door
RD103	DANA 35, C-CLIP, XJ, YJ, ZJ, TJ, WJ; 29.5 (1.16") Shaft; 27 Spline; 2.73-3.31 Ratio	Rear 97-06 Wrangler TJ/Unlimited
RD116	DANA 44 1,3; 33.3 (1.31") Shaft; 30 Spline; 3.92 & UP1 Ratio	Rear 97-06 Wrangler TJ/Unlimited
CKSA12	12 Volt; 0.88 CFM At 0 PSI To 0.47 CFM At 29 PSI	Locker Compressor

1 Will Not Fit Rubicon Models
2 Aftermarket Axle Shafts Required, Not supplied by ARB

3 Will work with JK Rubicon Dana 44 housing
4 Will work with JK Rubicon Dana 44 gears ONLY ONLY

All Jeep® JK Dana 44 ring gears are thick and require a 3.73 and down carrier. The RD 117, RD 147 & RD 157 are all 3.73 and down carriers and are suitable for the JK Dana 44 housing and ring and pinion gear sets.



Air Supply - Air Compressors

- Constructed primarily of light weight, high strength, engineering grade materials, including military and aerospace standard components
- Pressure switch controlled air manifold system regulates pressure between 9.3Bar [135PSI] and 10.3Bar [150PSI] suited to air tools and all ARB Air Locker equipped vehicles
- Highest air flow rate of any 12V compressor of its size on the market at 174LPM [6.16CFM]
- High efficiency design consumes only 56 Amps at maximum air flow



Part No. CKMTA12 - 12V
Part No. CKMTA24 - 24V



Synthetic Gear Oils Shockproof® Gear Oil (GL-5)

Recommended for heavily loaded racing differentials and transmissions which see shockloading. Contains a unique solid dispersion which cushions gear teeth to help prevent tooth breakage and allows the use of lower viscosities.

- Part No. 58504 - SuperLight (Quart)
- Part No. 58404 - LightWeight (Quart)
- Part No. 58204 - Heavy (Quart)



GL-5 Gear Oil for Differentials

Designed to provide excellent low-temperature shiftability and improved gear protection at higher temperatures. The synthetic base stocks used have tremendous thermal stability and provide the best film strength available.

Part No.	Description
57904	75W90 GL-5
58304	75W90NS GL-5 (for transaxle use)
57914	75W140 GL-5
58104	80W140 GL-5
57804	75W110 GL-5



Synthetic Gear Oil

- Heavy-duty, high performance
- Stands up to high performance
- Cools and quiets

- Part No. 10047 - 75W-90
- Part No. 10121 - 75W-140



Max Gear™ Synthetic Differential Oil

Max Gear is recommended for use in truck and automotive front or rear differentials, manual transmissions and lower gear units of marine engines that specify use of an API GL-5 or GL-4 fluid. It is non-corrosive to soft yellow metals (brass, bronze, copper, etc.) and synchronizer safe. Specially designed to extend gear and bearing life. Max Gear makes gears run smoother, quieter, cooler and longer without overhauls. Max Gear is formulated with a friction modifier additive - no additional additives are necessary.

Part No.	Description	Part No.	Description
01301	75W-140 Qt.	05390	75W-90 5 Gal.
05301	75W-140 5 Gal.	01303	85W-140 Qt.
01300	75W-90 Qt.		





Which Clutch Is Right For You?

- Centerforce® offers multi-level product lines allowing customers to chose a performance clutch that matches their application and driving style
- The unique Centerforce design allows for easy pedal effort and everyday drivability, while offering increased holding capacity for maximum performance
- Centerforce engineers evaluate each assembly and apply their patented processes to increase the clutches holding-capacity and performance

NEW



Billet Steel Flywheel

- Neutral Balance
 - 50.65 Pounds
 - SFI Approved
 - AD/CAM-Designed And CNC-Machined From Billet Steel
 - No-Hassle, Bolt-In Installation
- Part No. 700474** - 07-11 Wrangler



Centerforce® II

- Full-facing-disc with premium friction materials
- Patented Centerforce centrifugal weights (where applicable)
- Static clamp load is increased via their patented machining processes
- Superb holding power and maximum clutch life, making this stage ideal for selected street/strip, off-road, and towing applications



Centerforce Dual Friction®

- Patented processes to provide a performance clutch that offers exceptional street characteristics
- Outstanding holding capacity and durability
- Full facing on the pressure plate side for drivability
- Carbon composite puc style (segmented) on the flywheel side for a positive engagement
- The ultimate in street/strip holding power and performance without sacrificing pedal effort and driver control

Clutch Kit Part No.	Series	Application
KDF643791/ KCFT379176	Centerforce® II	12-15 Wrangler 3.6L
KDF379176	Dual Friction	12-15 Wrangler 3.6L
DF098391	Dual Friction	07-11 Wrangler 3.8L
DF193890	Dual Friction	86-06 Wrangler 4.0/4.2L
DF201614	Dual Friction	87-02 Wrangler 2.5L



Megashifter™ Automatic Shifter

With B&M's Megashifter you can't miss a gear. The Megashifter has a universal floor mount that can be trimmed to fit any floor. It is cable operated and includes a 5' cable.

Kit includes a neutral safety switch, backup light switch, lighted gear indicator, and a polished aluminum T-handle.

Part No. 80680 - Jeep® AMC 727, 904 & 999 transmissions; Also Fits GM TH400, 350, 700R4 transmissions.



Ripper Shifter

Engineered for substantially shorter shift throws CNC-machined 303 stainless steel shifter levers and T6 aluminum base houses a special spherical bearing 30% shift throw reduction.

Part No. 45048 - 00-03 Jeep® Wrangler with 350



Clutch Sets

NEW

- 2+ Offers drivability and engagement quality characteristic of the stage 2, but with a 15 to 20% higher torque capacity
- Hub is double sprung with spring cover relieves for flexibility and heat treated components for strength and durability
- Great for street, drag, autocross, road racing, pulling, rallye and drift
- High clamp pressure plate
- High torque sprung hub and disc assembly

Part No.	Application
SJ382	07-11 Wrangler 3.8L - Stage 1 - Segmented Or Full Faced Pure Kevlar Disc With Steel Backing
SJ383H	07-11 Wrangler 3.8L - Stage 2 - Multi-Friction Disc Carbon Semi-Metallic On One Side And Kevlar On The Other
SJ633H	12-13 Wrangler 3.6L - Stage 2 - Multi-Friction Disc Carbon Semi-Metallic On One Side And Kevlar On The Other



Motive Gear®



Ring and Pinions

- CNC start to finish
- Cutting edge lapping
- Indexed tooth spacing
- Central contact pattern
- Computerized heat treatment

Part No.	Ratio	Part No.	Ratio	Part No.	Ratio	Part No.	Ratio
AMC 20		D30488F*	4.88	D44373	3.73	D44489F*	4.89
AM20331	3.31	D30488TJ	4.88" TJ"	D44392	3.92	D44513	5.13
AM20354	3.54	D30488RJK*	4.88" JK"	D44409	4.09	D44513F*	5.13
AM20373	3.73	DANA 35		D44409F*	4.09	D44513GX**	5.13" TJ"
AM20410	4.10	D35355	3.55	D44427	4.27	D44513JK	5.13" JK"
DANA 30		D35373	3.73	D44456	4.56	D44538F*	5.38
D30373TJ	3.73" TJ"	D35411	4.11	D44456F*	4.56	D44589	5.89
D30410	4.1	D35456	4.56	D44456GX**	4.56" TJ"		
D30410F*	4.1	D35488	4.88	D44488GX**	4.88" TJ"		
D30410TJ	4.10" TJ"	D35488F	4.88	D44488JK	4.88" JK"		
D30456	4.56	DANA 44		D44488RJK*	4.88" JK"		
D30456TJ	4.56" TJ"	D44354	3.55	D44489	4.89		
D30488	4.88	D44354F*	3.55				

*Front Rev. Cut

**Rubicon Front and Rear



Don't Forget The Installation Kit!

Master Bearing Kits

Part No.	Application
R20RMK	AMC 20 Style, 64-88
R30FRMK	DANA 30, TJ Style, Front
R30LRMK	DANA 30, TJ Style, Rear
R30LRAMK	DANA 30, 97-On TJ Style, Front
R30RMK	DANA 30, 66-90 Jeep®
R35JRMK	DANA 35, 64-Up Jeep®

Choose The Gear Ratio That Is Best For Your Vehicle

When selecting a Gear Ratio, you should consider the following:

- Tire Size
- Transmission Ratio
- Final Gear Ratio
- Engine RPM at Cruise Speed

The following formula has been developed to calculate the optimum final Gear Ratio to suit your application.

M.P.H X Gear Ratio

Tire Diameter X 336 = rpm _____

The chart shown below shows RPM calculations at 55 MPH for various combinations of final Gear Ratio and Tire Diameter.

According to this chart, the acceptable RPM range is 2000-3000 which is represented by the entire shaded area of the chart. The optimum RPM range is 2300-2600, and it is represented by the white area between the two red areas. When changing ratios to improve mileage, choose a ratio within the red shaded band above the optimum range. When changing ratios to improve power, choose a ratio within the red shaded band below the optimum range.

Gear Ratio	Tire Diameter																
	24	25	26	27	28	29	30	31	32	33	34	35	36	38	40	42	44
2.56	1972	1892	1820	1752	1690	1631	1577	1526	1478	1434	1391	1352	1314	1245	1183	1126	1075
2.73	2102	2018	1940	1869	1802	1740	1682	1627	1577	1529	1484	1441	1401	1328	1261	1201	1147
2.94	2264	2173	2090	2012	1942	1874	1811	1753	1698	1646	1599	1552	1509	1429	1358	1294	1235
3.08	2372	2277	2189	2108	2033	1963	1897	1836	1779	1725	1674	1626	1581	1498	1423	1355	1294
3.21	2472	2373	2282	2197	2119	2046	1977	1914	1854	1798	1745	1695	1648	1561	1483	1412	1348
3.31	2549	2447	2353	2266	2185	2110	2039	1973	1912	1854	1799	1748	1699	1610	1529	1456	1390
3.42	2633	2528	2433	2341	2257	2179	2107	2039	1975	1915	1859	1806	1756	1663	1580	1505	1436
3.54	2726	2617	2516	2423	2336	2256	2181	2110	2044	1982	1924	1869	1817	1722	1635	1558	1487
3.73	2872	2757	2651	2553	2462	2377	2298	2224	2154	2089	2027	1969	1915	1814	1723	1641	1567
3.90	3003	2883	2772	2669	2574	2485	2402	2325	2252	2184	2120	2059	2002	1897	1802	1716	1638
4.10	3157	3031	2914	2806	2706	2613	2526	2444	2368	2296	2228	2165	2105	1994	1894	1804	1722
4.27	3288	3156	3035	2923	2818	2721	2630	2545	2466	2391	2321	2255	2192	2077	1973	1879	1793
4.56	3511	3371	3291	3121	3010	2906	2809	2718	2633	2554	2478	2408	2341	2218	2107	2006	1915
4.88	3758	3607	3469	3340	3221	3110	3006	2909	2818	2733	2652	2577	2505	2373	2255	2147	2050
5.29	4073	3910	3760	3621	3491	3371	3259	3154	3055	2962	2875	2793	2716	2573	2444	2328	2222
5.38	4143	3977	3824	3682	3551	3428	3314	3207	3107	3013	2924	2841	2762	2616	2486	2367	2260
5.71	4397	4221	4058	3908	3769	3639	3517	3404	3298	3198	3104	3015	2931	2777	2638	2512	2398
6.17	4751	4561	4385	4223	4072	3932	3801	3678	3563	3455	3354	3258	3167	3001	2851	2715	2591
7.17	5521	5300	5096	4907	4732	4569	4417	4274	4141	4015	3897	3786	3681	3487	3313	3155	3011





Ring and Pinion Sets



Dana 44

Part No.	Ratio	Teeth
AMC Jeep® C101 (rear) 67-72		
AMC Jeep® CJ5 (front/rear) 67-75		
AMC Jeep® CJ7 (front/rear) 67-75		
AMC Jeep® Wagoneer (front/rear) 67-83		
6902161 ³	4.10	41-10
6902181 ^{1,3}	4.56	41-9

1 Reverse.
3 Fits 3.92 and numerically higher carrier.

Dana 60

Part No.	Ratio	Teeth
66-84 Jeep® J10 (rear)		
Street Gears		
6900521 ³	4.10	41-10

1 Reverse.
2 Fits 3.07-4.10 carrier.
3 Fits 4.56 and numerically higher carrier.

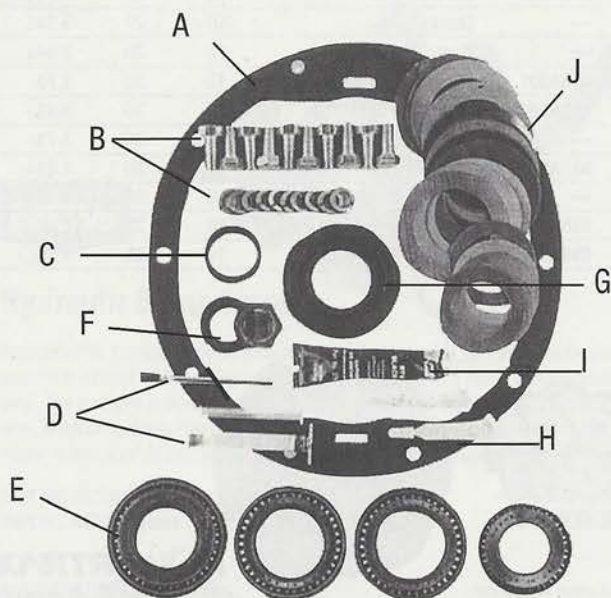

Ring and Pinion Installation Kits

- | | |
|--------------------------------|-----------------------------|
| A. Cover gasket | F. Pinion nut and washer |
| B. Ring gear bolts and washers | G. Pinion seal |
| C. Crush sleeve | H. Thread locking compound |
| D. Marking compound and brush | I. Silicone |
| E. Pinion and carrier bearings | J. Pinion and carrier shims |

Part No. 8310331 - Dana 44 30 Spline Complete Kit
Part No. 8310341 - Dana 60 Complete Kit



Evolution Series Axle Kits

Superior chrome-moly axles use a proprietary dual heat treatment process that gives them ultimate durability. Superior's heat treating, along with our Exclusive Torque Equalizing Diameter Profiles, allows the "short" side axles to have similar ductility or "give" as the "long" side, creating a more reliable and balanced axle assembly. The high-quality and innovative engineering provides you with a 40-50% strength increase over stock axle shafts. Made in the USA.

Front Axle Kits

Left Part No.	Right Part No.	Application
EV32LFS	EV32RFS	87-95 YJ, XJ, and MJ w/Disconnect Element
EV33LFS	EV33RFS	97-06 TJ, XJ, ZJ, and WJ
EV45LFS	EV45RFS	03-06 Rubicon
EV50LFS	EV50RFS	07-11 JK Wrangler
EV51LFS	EV51RFS	07-11 JK Rubicon

Rear Axle Kits

Part No.	Application
EV20L	83-85 CJ
EV20E	72-82 CJ
EV50	07-11 JK Non-Rubicon
EV52	07-11 JK Rubicon



Jeep® Steering Shafts

Jeep®'s original steering shaft assembly was not designed for the added stress of body lifts and oversize tires. BORGESON'S replacement assembly has a telescoping shaft with two precision needle bearing u-joints. Steering Assembly Is Easy Install With Common Hand Tools.



Part No.	Application
000873	01-06 Wrangler
000875	97-02 Wrangler (TJ) Power Steering Lower Shaft
000893	84-00 Cherokee and Wagoneer (XJ)
000910	76-86 Jeep® CJ5/CJ7, With Complete Steering Shaft
000920	76-86 Jeep® CJ5/CJ7, With Complete Steering Shaft And Vibration Reducer
000925	87-95 Wrangler, with Vibration Reducer
000926	87-95 Wrangler

Selecting a Differential

- Open Differentials: This century-old technology delivers virtually all the engine power to the wheel that begins to slip first. Although open differentials work adequately on ideal driving surfaces, they perform poorly under adverse traction conditions.
- Limited-slip differentials behave very much like open differentials. Through various forms of friction mechanisms, they transfer a relatively small amount of power to the non-slipping wheel. They are generally smooth and quiet, but as the name implies, performance improvement is limited.
- Locking differentials, in effect, lock the two drive wheels together -- somewhat like "spools" that solidly connect the axles together. When powering straight ahead, engine power is equally delivered to both drive wheels. Although locking differentials deliver excellent traction output and allow full wheel differentiation when turning, they are notoriously harsh and noisy.
- Spools are designed to take the place of stock type spider & side gears to provide maximum traction.

Differential Type	Traction	On Road Handling	Off Road Handling	Reliability
Conventional or Open	Poor	Fair	Poor	Fair
Limited Slip	Good	Good	Good	Good
Automatic Locker	Excellent	Fair	Excellent	Excellent
Selectable Locker	Excellent	Good	Excellent	Good
Spool/Mini Spool	Excellent	Poor	Good	Excellent



Eaton® Performance Differentials

Eaton ELocker

- Push button traction
- Positive-electronic lock
- Virtually maintenance free

The ELocker's electromagnetic locking mechanism is the next generation of aftermarket differential technology. Performs as an open differential until you decide that you need more traction.

Designed expressly for 4-wheel drive systems, the ELocker is built with precision forged gears that are designed to mesh perfectly. Its ease of installation, reliability and push-button activation make ELocker an absolute must for all traction and off-road performance applications.



Eaton Detroit Truetrac

- Smooth operation
- Performs open until needed
- Fully automatic limited slip

Detroit Truetrac remains the leading helical gear-type limited slip differential in the industry. Its proven helical gear design eliminates the need for wearable parts, resulting in maintenance free traction. Recognized not only for its toughness but also for the smooth and quiet operation.

Proven design, low cost, and effective performance all make the Detroit Truetrac limited slip differential the ideal choice for a wide variety of vehicle applications. No maintenance...just traction!



ELocker Part No.	Truetrac Part No.	Application	Cover Bolts	Axle Spline	Ratio
19818010	912A588	Dana 30 (Front)	10	27	3.73+
19821010	—	Dana 35	10	27	3.54+
19822010	—	Dana 35	10	30	3.54+
19977010	913A591	Dana 44 (Front)	10	30	3.73-
—	913A592	Dana 44 (Front)	10	30	3.92+
19977010	—	Dana 44 (Rear)	10	30	3.73-
—	913A590	Dana 44 (Rear)	10	30	3.92+
19760010	—	Dana 60 (Rear) Non C-Clip	10	35	4.10-
19761010	915A386	Dana 60 (Rear) Non C-Clip	10	35	4.56+
19760010	915A387	Dana 60 (Front)	10	35	4.10-



For the off-road enthusiast, the Lock-Right Locker is one of the most important additions you could add to your vehicle. High horsepower, lift kits and larger tires will only get you so far on the trail because a loss of traction will leave you stuck. With a Lock-Right installed, you will always get maximum traction to the wheels that need it most. Operation is fully automatic to keep you moving and focused on the trail.

Part No.	Differential Type
1710	AMC-20 Open
2210	DANA 30 27t, Open
2310	DANA 35 27t, Open, C-clip, Non ABS case
2311	DANA 35 27t, Open, C-clip, ABS case
2410	DANA 44 30t, Open
2620	DANA 60 35t, Open



Keeping Jeep® Vehicles on and off the road for over 50 years!

Axle / Differential Axle Shaft Bearing Kits

For Wrangler Rear Axles

Replaces Part No.	Years	Axle	Comments
D44TJBK	97 - 02	Dana 44	Incl. Ring, Seal, Bearing & Retainer
D44TJBK	03 - 06	Dana 44	with Drum Brakes, (Ring, Seal, Bearing, Ret.)
D44TJDBK	03 - 06	Dana 44	with Disc Brakes, (Ring, Seal Bearing, Ret.)
D44JKBK	07 - 11	Dana 35, 44	Incl. Ring, Seal & Bearing



U-Bolt Type Pinion Yoke Kits

Replaces Part No.	Comments
D35YOKEUBK	For Dana 35 Rear Axle Kit Includes: U-Bolt Type Yoke, Flange Nut, 2 U-Bolts w/ Washers, Nuts and Pinion Seal
D3044YOKEUBK	For Dana 30 or 44 Front or Rear Axles Kit Includes: Yoke, U-bolts w/ Washers, Nuts, Pinion Seal, Pinion Washer And Pinion Nut
AMC20YOKEUBK	For AMC Model 20 Rear Axles Kit Includes: Yoke, U-Bolts w/ Washers, Nuts, Pinion Seal, Pinion Washer and Pinion Nut



Transfer Case Speedometer Gears

For Use with NP 231 Transfer Case, 1990 to 2006

Replaces Part No.	Comments
52067632	32 Tooth, Black
52067634	34 Tooth, Green
52067635	35 Tooth, Orange
52067636	36 Tooth, Brick Red
52067638	38 Tooth, Blue
52067639	39 Tooth, Dark Green
52067632K	Kit, Includes 1 of Each Size



Speedometer Gear Tooth Count Selection

When purchasing individual speedometer gears, we recommend also purchasing O-ring (Replaces Part No. 6035709).

TOOTH COUNTS	AXLE RATIO							
	3.07	3.55	3.73	4.10	4.56	4.88		
T 27"	31 *	36	37 *					
I 28"	30 *	35	36					
R 29"	29 *	34	35					
E 30"		33 *	34					
S 31"		32	33 *	37 *				
I 32"		31 *	32	36				
Z 33"			31 *	35				
E 35"			29 *	33 *	37 *			
			28 *	32	36	38		
			28 *	32	35	37 *		

* This size is not carried by Crown Automotive

Steering

Lower Steering Shafts

Replaces Part No.	Years	Model	Comments
5353135HD	76-83	CJ-5	without Power Steering; HD
5354934HD	76-83	CJ-5	with Power Steering; HD
5353135	76-83	CJ-5	without Power Steering
J5354934	76-83	CJ-5	with Power Steering
5353135HD	76-86	CJ-7	without Power Steering; HD
5354934HD	76-86	CJ-7	with Power Steering; HD
J5353135	76-86	CJ-7	without Power Steering
J5354934	76-86	CJ-7	with Power Steering
5353135HD	81-86	CJ-8	without Power Steering; HD
5354934HD	81-86	CJ-8	with Power Steering; HD
J5353135	81-86	CJ-8	without Power Steering
J5354934	81-86	CJ-8	with Power Steering
52007017	87-95	YJ Wrangler	with Power Steering
52078705	97-01	TJ Wrangler	with or without Power Steering



Suspension Control Arms

Replaces Part No.	Years	Model	Position
52087711	97-06	TJ Wrangler	Upper Front
52001162	97-06	TJ Wrangler	Lower F or R
52087854	97-06	TJ Wrangler	Upper Rear
52059979AC	07-14	JK Wrangler	Lower Front
52060021AD	07-14	JK Wrangler	Lower Rear
52059976AC	07-14	JK Wrangler	Upper Front
52060015AD	07-14	JK Wrangler	Upper Rear



Leaf Springs

Replaces Part No.	Years	Model	Position	Comments
J5363229	76-83	CJ-5	Front	Standard - 4 Leaves
J5354892	76-83	CJ-5	Front	Heavy Duty - 7 Leaves (6/1)
J5363229	76-86	CJ-7	Front	Standard - 4 Leaves
J5354892	76-86	CJ-7	Front	Heavy Duty - 7 Leaves (6/1)
J5363229	81-86	CJ-8	Front	Standard - 4 Leaves
J5354892	81-86	CJ-8	Front	Heavy Duty - 7 Leaves (6/1)
J5363331	76-83	CJ-5	Rear	Standard - 6 Leaves
J5356423	76-83	CJ-5	Rear	Heavy Duty - 9 Leaves (7/2)
J5363331	76-86	CJ-7	Rear	Standard - 6 Leaves
J5356423	76-86	CJ-7	Rear	Heavy Duty - 9 Leaves (7/2)
J5363331	81-86	CJ-8	Rear	Standard - 6 Leaves
J5356423	81-86	CJ-8	Rear	Heavy Duty - 9 Leaves (7/2)
4636975	87-95	YJ Wrangler	Front	Standard - 4 Leaves
52003448	87-95	YJ Wrangler	Front	Heavy Duty - 4 Leaves

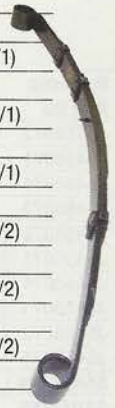

Body Body Mount Kits

Replaces Part No.	Year	Model
5462446K	79 - 86	CJ-5, 7, 8
52002723K	87 - 95	YJ Wrangler
55176180K	97 - 06	TJ Wrangler
55366676K2	07 - 13	JK Wrangler, 2 Door
55366676K4	07 - 13	JK Wrangler, 4 Door



Hoods

Replaces Part No.	Years	Model
J5761180	72-83	CJ-5
J5761180	76-86	CJ-7
J5761180	81-86	CJ-8
55345059	87-95	YJ Wrangler
55176594*	97-05	TJ Wrangler
68002350AB	07-14	JK Wrangler



* With Oval Hood Rod Hole

Windshield Frames

Replaces Part No.	Years	Model
J0987996	69-75	CJ-5, 6
J5758971	76-83	CJ-5
J5758971	76-86	CJ-7, 8
55020432	87-95	YJ Wrangler
55174607AD	97-02	TJ Wrangler



Crown Automotive Sales Co., Inc. and RT Off-Road are not affiliated with FCA US LLC. Part Numbers are used for reference purposes only. No implication is made that the actual products sold are the product of the original equipment manufacturer.



Fenders

Replaces Part No.	Years	Model	Side
J5758964	72-83	CJ-5	Right
J5758618	72-83	CJ-5	Left
J5758964	76-86	CJ-7	Left
J5758618	76-86	CJ-7	Left
J5758964	81-86	CJ-8	Right
J5758618	81-86	CJ-8	Left
55013514	87-95	YJ Wrangler	Right
55013515	87-95	YJ Wrangler	Left
5003950AD	97-06	TJ Wrangler	Right
5003951AD	97-06	TJ Wrangler	Left
68002398AD	07-14	JK Wrangler	Right
68002399AD	07-14	JK Wrangler	Left

Fender Flares



Replaces Part No.	Year	Model	Position	Side	Comments
J5455072	55-83	CJ-5	Front	Right	
J5455071	55-83	CJ-5	Front	Left	
J5455074	55-83	CJ-5	Rear	Right	
J5455073	55-83	CJ-5	Rear	Left	
J5455072	76-86	CJ-7	Front	Right	
J5455071	76-86	CJ-7	Front	Left	
J5455074	76-86	CJ-7	Rear	Right	
J5455073	76-86	CJ-7	Rear	Left	
J5455072	81-86	CJ-8	Front	Right	
J5455071	81-86	CJ-8	Front	Left	
5AH16JX9	81-86	CJ-8	Rear	Right	
5AH17JX9	81-86	CJ-8	Rear	Left	
5AH15JX9	87-95	YJ Wrangler	Front	Left	Except Renegade
5AH14JX9	87-95	YJ Wrangler	Front	Right	Except Renegade
5AH16JX9	87-95	YJ Wrangler	Rear	Right	Except Renegade
5AH17JX9	87-95	YJ Wrangler	Rear	Left	Except Renegade
55254918	97-06	TJ Wrangler	Front	Right	Textured Black
55254919	97-06	TJ Wrangler	Front	Left	Textured Black
55175726	97-06	TJ Wrangler	Rear	Right	Textured Black
55175727	97-06	TJ Wrangler	Rear	Left	Textured Black
5KF08RXFAG	07-14	JK Wrangler	Front	Right	Textured Black
5KF09RXFAG	07-14	JK Wrangler	Front	Left	Textured Black
5KF16RXFAE	07-14	JK Wrangler	Rear	Right	Textured Black
5KF17RXFAE	07-14	JK Wrangler	Rear	Left	Textured Black

Fender Flare Kits



Replaces Part No.	Year	Model	Comments
J8997109	55-83	CJ-5	4 Piece Kit; Includes Hardware
J8997109	76-86	CJ-7	4 Piece Kit; Includes Hardware
8997109CJ8	81-86	CJ-8	4 Piece Kit; Includes Hardware
5AHK	87-95	YJ Wrangler	4 Piece Kit; Includes Hardware
5AHK-6	87-95	YJ Wrangler	6 Piece Kit; Includes Hardware
55254918K	97-06	TJ Wrangler	4 Piece Set; Flat Black; OE Width
55254918K7	97-06	TJ Wrangler	4 Piece Set; Flat Black; 6-5/8" Wide
55254918K6	97-06	TJ Wrangler	6 Piece Set; Flat Black; OE Width
55254918K76	97-06	TJ Wrangler	6 Piece Set; Flat Black; 6-5/8" Wide
5KFK	07-14	JK Wrangler	4 Piece Set, Includes Hardware
5KFK-FR	07-14	JK Wrangler	2 Piece Kit, Inc. Hardware (Front Only)
5KFK-RR	07-14	JK Wrangler	2 Piece Kit, Inc. Hardware (Rear Only)

Crown Automotive Sales Co., Inc. and RT Off-Road are not affiliated with FCA US LLC. Part Numbers are used for reference purposes only. No implication is made that the actual products sold are the product of the original equipment manufacturer.

Tune Up Kits

Replaces Part No.	Model	Years	Engine
TK27	CJ-5, 7, 8	78-79	4.2
TK28		80-82	4.2
TK29		83-86	4.2
TK30		78-81	5.0

Replaces Part No.	Model	Years	Engine
TK12 *	YJ Wrangler	87-90	2.5
TK13 **		91-93	2.5
TK14 ***		91-93	2.5
TK15		94-95	2.5
TK1		87-90	4.2
TK2		91-93	4.0
TK3		94-95	4.0
TK43	TJ Wrangler	03-06	2.4
TK16		97-98	2.5
TK26		99-02	2.5
TK4		97-98	4.0
TK25		19-9	4.0
TK45	JK Wrangler	07-11	3.8L

* With EFI (Fuel Injection)
 ** SAE Oil Filter Thread
 *** METRIC Oil Filter Thread

Replaces Part No.	Model	Years	Engine
TK32	SJ J-Series	87-90	4.2
TK31		83-86	5.9
TK33		87-90	5.9
TK34		91-92	5.9

Replaces Part No.	Model	Years	Engine
TK17	XJ Cherokee	87-90	2.5
TK18 *		91-93	2.5
TK19 **		91-93	2.5
TK20		94-96	2.5
TK21		97-98	2.5
TK22		99-00	2.5
TK5		87-90	4.0
TK6		91-93	4.0
TK7		94-96	4.0
TK8		97-98	4.0
TK9		1999	4.0

* SAE Oil Filter Thread
 ** METRIC Oil Filter Thread

Replaces Part No.	Model	Years	Engine
TK10	ZJ Grand Cherokee	93-96	4.0
TK11		97-98	4.0
TK23		93-96	5.2
TK24		97-98	5.2, 5.9
TK35	WJ Grand Cherokee	99-01	4.0
TK48		02-04	4.0
TK36		99-04	4.7
TK46	WK Grand Cherokee	05-07	4.7
TK47		05-08	3.7
TK39	KJ Liberty	02-03	2.4
TK40		04-05	2.4
TK41		02-03	3.7
TK42		04-07	3.7

* With H.O. Engine

CV Joint Repair Kits

Replaces Part No.	Model	Years	Position
528533FRK	JK Wrangler	07-13	Front
520994FRK	WJ, WG, KJ	99-07	Front
520994RRK	WJ, WG, KJ	99-07	Rear
528534RRK	WK, WH, XK, XH DN, HB, AN, ND, NM	01-10	Rear



Spacer Lift Kits

These Lift Kits are easily installed without drilling or cutting. They will provide stock Jeep® Vehicles with more clearance, which will allow the use of oversized tires and increase maneuverability on rough trails.



Replaces Part No.	Model	Year	Comments
TJ2SP	TJ Wrangler	97/06	1 3/4" Lift
TJ2SPMK	TJ Wrangler	97/06	1 3/4" Lift *
JK2SP	JK Wrangler	07/12	1 3/4" Lift
TJ2SP	ZJ Grand Cherokee	93/98	1 3/4" Lift
WJ2SP	WJ, WG Grand Cherokee	99/04	1 3/4" Lift
WK2SP	WK Grand Cherokee	05/10	2" Lift
WK2SP	XK Commander	06/10	2" Lift
XJ2SP	XJ Cherokee	84/01	1 3/4" Lift
RT21050	KJ Liberty	02/07	2" Lift

* Master Kit, Includes HD Shocks



Heavy Duty Greasable Shackle Kits

Kits Include: Plates, bushings and all required hardware. Effectively lifts vehicle 3/4." Heavy Duty Plate Steel Construction. One kit completes both front and rear of vehicle. Includes installation instructions.

Replaces Part No.	Model	Year	Description
916646HD	CJ	53-75	For 2 Springs
52040415KHD	YJ Wrangler	87-95	For 2 Springs
52040415KHD2	YJ Wrangler	87-95	For 4 Springs



Heavy Duty Ball Joint Set

Sets include 1 Upper and 1 Lower Ball Joint with Hardware. The construction of our heavy duty ball joints are steps ahead of an OE style ball joint. We redesigned the internal assembly of the ball joint by replacing the plastic bushings with sintered metal. The characteristics of the sintered metal result in a heavy duty ball joint that will long outlast an OE style ball joint. Installation of our heavy duty ball joints is no different when compared to an OE style ball joint.

Replaces Part No.	Model	Year
68004085HD	JK Wrangler	07-14
83500202HD	TJ Wrangler	97-06
83500202HD	YJ Wrangler	87-95
83500202HD	XJ Cherokee	84-01
83500202HD	MJ Comanche	86-92
68004085HD	WJ Grand Cherokee	99-04
83500202HD	ZJ Grand Cherokee	93-98



Heavy Duty Steering Kits

Heavy duty solid steel construction. No modifications needed to factory mounting components. Includes all hardware needed for installation.



Steering Stabilizer Included

Replaces Part No.	Model	Year	Drive Side
HDSTRGCR2	XJ Cherokee, MJ Comanche	91-01	LHD
HDSTRGCR4	XJ Cherokee	94-01	RHD
HDSTRGCR2	TJ Wrangler	97-06	LHD
HDSTRGCR4	TJ Wrangler	97-04	RHD
HDSTRGCR2	ZJ Grand Cherokee w/4.0L	93-98	LHD
HDSTRGCR4	ZG Grand Cherokee w/4.0L	94-98	RHD (Europe)

Steering Stabilizer Not Included

Replaces Part No.	Model	Year	Drive Side
HDSTRGCR1	XJ Cherokee, MJ Comanche	91-01	LHD
HDSTRGCR3	XJ Cherokee	91-01	RHD
HDSTRGCR1	TJ Wrangler	97-06	LHD
HDSTRGCR3	TJ Wrangler	97-04	RHD
HDSTRGCR1	ZJ Grand Cherokee w/4.0L	93-98	LHD
HDSTRGCR3	ZG Grand Cherokee w/4.0L	94-98	RHD (Europe)

These Heavy Duty Greasable Shackles are made from 1/4" plate and feature a greasable bushing for a noise-free ride.

Replaces Part No.	Model	Year	Description
52000507KHD	XJ Cherokee	84-01	1.5" Lift
52000507KHD	MJ Comanche	86-92	0.75" Lift



Slip Yoke Eliminator and HD CV Propeller Shaft Kit

This kit contains everything you need to convert the rear output of the NP231 transfer case to a fixed-style yoke. Included in this kit is a heavy duty 32 spline main shaft, a short output housing, a CV-style yoke and all the necessary hardware. When paired with the provided propeller shaft, these will result in an extremely strong, vibration free driveline that will provide you with years of worry free driving.

Replaces Part No.	Model	Year
SYE231SK	TJ Wrangler	97-06
SYE231SK	YJ Wrangler	87-93
SYE231SK*	YJ Wrangler	94-95

*With 1310 (3.219" Width) Series U-Joints. If 94/95 YJ has 1330 Series U-Joint, also purchase Part # D35-YOKE-UBK.



Slip Yoke Eliminator Kit

Replaces Part No.	Model	Year
SYE231	TJ Wrangler	97-06
SYE231	YJ Wrangler	87-93
SYE231	XJ Cherokee	87-01
SYE231	MJ Comanche	87-92



Heavy Duty Control Bracket Arm Set

Heavy duty 3/16" plated steel construction will ensure long lasting performance even with the most rigorous off-road use. The slotted cam bolt design will allow you to dial in your front caster and improve overall ride quality.

Sold in pairs; Welding required; Replacement cam bolt available separately.

Replaces Part No.	Model	Year
52088654BR	TJ Wrangler	97/06
52088654BR	XJ Cherokee	84/01
52088654BR	MJ Comanche	86/92
52088654BR	ZJ Grand Cherokee	93/98



Heavy Duty Differential Covers

NEW

These covers are constructed of 3/8" high grade forged steel with a raised fill plug for extra oil capacity. They feature strengthening ribs to ensure a broken or peeled differential cover doesn't cut the day short. The mating surface is machined flat to ensure a leak-free fitment. All covers are finished in a red powder coat and include flanged hex bolts as well as RTV.

Replaces Part No.	Axle	Year	Position	Model
RT20024	D30	47-15	Front or Rear	Universal
RT20025	D35	87-93	Rear	Universal
RT20026	D44	94-95	Front or Rear	Universal
RT20027	8.25"		Rear	Universal

Crown Automotive Sales Co., Inc. and RT Off-Road are not affiliated with FCA US LLC. Part Numbers are used for reference purposes only. No implication is made that the actual products sold are the product of the original equipment manufacturer.





**Accessories and Upgrades
for Jeep® Enthusiasts!**

Stainless Steel Brake Line Kits

RT Off-Road Stainless Steel Brake lines are designed for modified vehicles requiring additional length and performance. The additional length and stainless construction provides long lasting performance on modified vehicles. All brake lines are D.O.T. approved, 50 state legal.



Replaces

Part No.	Model	Year	Comment
7405	CJ-7, 8	82-86	Up to 4" Lift
7425	YJ Wrangler	87-95	Up to 6" Lift
7425	TJ Wrangler	97-02	Up to 6" Lift
7475	JK Wrangler	07-11	Up to 6" Lift
7425	XJ Cherokee	84-01	Up to 6" Lift

Drum To Disc Brake Conversion Kits

These disc brake conversion kits will convert Jeeps® with Dana 35 or Chrysler 8.25 rear axles from drum brakes to disc brakes. A MUST for vehicles with oversized tires.



Kit fits Jeep® vehicles w/ Dana 35 Axles without ABS.

Kit Includes: Pads, Rotors, Parking Brake Assembly, Calipers, Mounting Brackets, Brake Hoses, Parking Brake Cables and Hardware.

Kit fits Jeep® vehicles w/ Dana 35 C-Clip and Chrysler 8.25" Axles without ABS.

Kit Includes: Pads, Rotors, Parking Brake Assembly, Calipers, Mounting Brackets, Brake Hoses and Hardware.

Does not include Parking Brake cable.

Replaces

Part No.	Model	Year
D35DISC	TJ Wrangler	97-06
D35DISC	ZJ Grand Cherokee	93-98

Replaces

Part No.	Model	Year
D35DISC2	TJ Wrangler	97-06
D35DISC2	XJ Cherokee	91-01
D35DISC2	YJ Wrangler	91-95
D35DISC2	ZJ Grand Cherokee	93-98

Brake Cables for use with D35DISC2

Replaces

Part No.	Model	Years	Length	Position
52008904	TJ Wrangler	97-06	44"	Right
52008905	TJ Wrangler	97-06	43.80"	Left
DBC01	YJ Wrangler	87-90	64.75"	Right
DBC02	YJ Wrangler	87-90	32.75"	Left
DBC03	YJ Wrangler	91-95	69.75"	Right
DBC04	YJ Wrangler	91-95	37.5"	Left
DBC05	XJ Cherokee	84-96	52"	L or R
DBC06	XJ Cherokee	97-01	70.5"	Right
DBC07	XJ Cherokee	97-01	34.25"	Left
52008904	ZJ Grand Cherokee	93-98	44"	Right
52008905	ZJ Grand Cherokee	93-98	43.80"	Left



Header Kit, Stainless Steel

For Jeep® vehicles with 4.0L Engine. Polished 304 Stainless Steel. Bolt-In Application. 6-to-1 Collector for Increased HP and TQ. 2-1/2" Outlet. No cutting, grinding, or welding required.



Replaces

Part No.	Model	Years
4883385HDK	TJ, YJ Wrangler	91-99
4883385HDK	XJ Cherokee	91-99
4883385HDK	MJ Comanche	91-92
4883385HDK	ZJ Grand Cherokee	93-98

Halogen Lamp Conversion Kits

Convert from conventional OEM sealed beam headlamps to halogen lamps, bulbs included. Blue bulbs also available.



Lamps

Replaces Part No.	Model	Year	Comment
HC1000	TJ Wrangler	69-06	7" Round Assemblies
HC1000	CJ-5, 6, 7, 8	69-06	7" Round Assemblies
HC2000	YJ Wrangler	79-01	200MM Rectangular Assemblies
HC2000	MJ Comanche	79-01	200MM Rectangular Assemblies
HC2000	SJ	79-01	200MM Rectangular Assemblies
HC2000	XJ Cherokee	79-01	200MM Rectangular Assemblies
Bulbs			
H460W	YJ Wrangler	87-95	H4-60W Super White;2 bulbs; Europe
H460W	XJ Cherokee	84-01	H4-60W Super White;2 bulbs; Europe

Standard Blue Halogen Bulbs also available.

Clear Parking Lamps and Sidemarker Lamps

Amber bulbs keep these clear lenses street legal.



Parking and Signal Lamps

Replaces

Part No.	Model	Year	Position
55077884ADC	JK Wrangler	07-14	Right
55077885ADC	JK Wrangler	07-14	Left



Sidemarker Lamps

Replaces

Part No.	Model	Year	Position
55078144AAC	JK Wrangler	07-14	Right
55078145AAC	JK Wrangler	07-14	Left
56000110C	XJ Cherokee, MJ Comanche	84-96	Right
56000111C	XJ Cherokee, MJ Comanche	84-96	Left



Parking Lamp Kits

Includes: 2 Parking Lamps and 2 Amber Bulbs

Replaces

Part No.	Model	Year
55156488CK	TJ Wrangler	97-06
56001378CK	YJ Wrangler	87-95



Note: Modifications to Wiring Necessary for 94/95 YJ

Sidemarker Lamp Kits

Includes: 2 Sidemarkers and 2 Amber Bulbs

Replaces

Part No.	Model	Year
55155628CK	TJ Wrangler	97-06
56001424CK	YJ Wrangler	87-95



Parking and Sidemarker Lamp Kits

Includes: 2 Parking Lamps, 2 Sidemarkers and 4 Amber Bulbs

Replaces

Part No.	Model	Year
JKCR4	JK Wrangler	07-14
TJCR4	TJ Wrangler	97-06
YJCR4	YJ Wrangler	87-95



Note: Modifications to Parking Lamp Wiring Required for 94/95 YJ

Crown Automotive Sales Co., Inc. and RT Off-Road are not affiliated with FCA US LLC. Part Numbers are used for reference purposes only. No implication is made that the actual products sold are the product of the original equipment manufacturer.



Accessories and Upgrades for Jeep® Enthusiasts!

Wheel Spacer And Adapter Kits

RT Off-Road's new Wheel Spacers and Adapters are made from 1.5" thick 6061 T6 aluminum. These hub-centric and wheel-centric spacers are anodized blue for a long worry-free life. They come with Grade 8 studs pressed into the spacers, 10 lug nuts and thread locking compound. These will give you the aggressive look and improved stability you are looking for without breaking the bank on new wheels.



Replaces Part No.	Model	Year	Comments
WS55	JK Wrangler	07-14	5 x 5" Bolt Pattern
WS55	WJ, WG Grand Cherokee	99-04	5 x 5" Bolt Pattern
WS55	WK, WH Grand Cherokee	05-10	5 x 5" Bolt Pattern
WS55	XK, XH Commander	06-10	5 x 5" Bolt Pattern
WS5412	YJ Wrangler	87-95	5 x 4.5" Bolt Pattern
WS5412	TJ Wrangler	97-06	5 x 4.5" Bolt Pattern
WS5412	XJ Cherokee	84-01	5 x 4.5" Bolt Pattern
WS5412	MJ Comanche	86-92	5 x 4.5" Bolt Pattern
WS5412	ZJ Grand Cherokee	93-98	5 x 4.5" Bolt Pattern
WS5412	KJ Liberty	02-07	5 x 4.5" Bolt Pattern
WS5412	KK Liberty	08-10	5 x 4.5" Bolt Pattern
WS55	CJ-5, 7, 8	76-86	5 x 5.5" Bolt Pattern; 4.2" Center Bore

5 x 4.5" to 5 x 5" Adapters

Replaces Part No.	Model	Year
WA541255	TJ Wrangler	97-06
WA541255	YJ Wrangler	87-95
WA541255	XJ Cherokee	84-01
WA541255	MJ Comanche	86-92
WA541255	KJ Liberty	02-07
WA541255	KK Liberty	08-12
WA541255	ZJ, ZG Grand Cherokee	93-98

5 x 4.5" to 5 x 5.5" Adapters

Replaces Part No.	Model	Year
WA541255	TJ Wrangler	97-06
WA541255	YJ Wrangler	87-95
WA541255	XJ Cherokee	84-01
WA541255	MJ Comanche	86-92
WA541255	KJ Liberty	02-07
WA541255	KK Liberty	08-12
WA541255	ZJ, ZG Grand Cherokee	93-98

Fire Extinguisher Holder

Handy Fire Extinguisher Holder attaches to any roll bar or sports bar up to 3" diameter. Holds a 3 lb. extinguisher (not included). Attaches with adjustable Velcro straps. Available in red only.

Replaces Part No.	Model
FEHR	All Vehicles



Grab Bar Sets

These deluxe handles feature moulded rubber handles with heavy duty vinyl and Velcro 3-hook adjustable straps. Sold in pairs.

Replaces Part No.	Model
9301DELUXE	All Vehicles



These economy handles have a vinyl covered foam grab with a Velcro 2-hook adjustable strap. Sold in pairs.

Replaces Part No.	Model
9301	All Vehicles



Door Grab Handles

Includes 2 black nylon handles with rubber grips and an installation tool.

Replaces Part No.	Model	Year
DH1000K	TJ Wrangler	97-06
DH1001K	YJ Wrangler	87-95
DH1001K	CJ-5, 7, 8	76-86
RT27046	JK Wrangler	07-15



Interior Trim Package For JK Wrangler™

RT Off-Road interior trim pieces give the inside of the 07-10 JK Wrangler a distinctive fresh look. Pieces install in minutes with double sided tape. Constructed out of durable injection molded plastic and finished in either chrome or brushed silver. Trim pieces are available as a complete kit or in individual packages.



Chrome		Silver	
Replaces Part No.	Description	Replaces Part No.	Description
JKCKA2	Complete Kit 2 Door	JKCKA2	Complete Kit 2 Door
JKCKA4	Complete Kit 4 Door	JKCKA4	Complete Kit 4 Door
JKC6332	Shifter Bezel	JKC6332	Shifter Bezel
JKC6333	Steering Wheel Spokes	JKC6333	Steering Wheel Spokes
JKC6334	A/C Vent Cover (2)	JKC6334	A/C Vent Cover (2)
JKC6335	Speaker Cover (2)	JKC6335	Speaker Cover (2)
JKC6336	Cup Holder Trim	JKC6336	Cup Holder Trim
JKC6337	Grab Handle Cover	JKC6337	Grab Handle Cover
JKC6338	Rear Door Handle Covers (2)	JKC6338	Rear Door Handle Covers (2)
JKC6339	Front Door Handle Covers (2)	JKC6339	Front Door Handle Covers (2)
JKC6340	Door Handles (2)	JKC6340	Door Handles (2)
JKC6341	Center Console	JKC6341	Center Console

Vehicle Recovery Kit

The RT Off-Road Vehicle Recovery Kit is the most convenient collection of recovery parts available. Be prepared and have the right tools ready.



Replaces Part No.	Description
RT33013	Complete Vehicle Recovery Kit

Heavy Duty Transmission Oil Cooler Kit

Direct bolt in design; Tube and fin construction; Clean factory look; Helps prevent transmission from overheating.

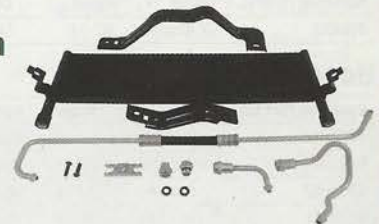

Replaces Part No.	Model	Year
RT24006	JK Wrangler	07-11

Sun Visor Set

Replaces Part No.	Description/Application
RT52001	Black, Jeep® Wrangler (TJ) (2003-2006)
RT52002	Agate, Jeep® Wrangler (TJ) (2003-2006)
RT52003	Spice, Jeep® Wrangler (TJ) (2003-2006)
RT54001	Black, Jeep® CJ (1955-1986)
RT54002	Gray, Jeep® CJ (1955-1986)
RT54003	Spice, Jeep® CJ (1955-1986)



Crown Automotive Sales Co., Inc. and RT Off-Road are not affiliated with FCA US LLC. Part Numbers are used for reference purposes only. No implication is made that the actual products sold are the product of the original equipment manufacturer.

Door Handles

Stainless; Fits: 07/14 JK Wrangler™, 08/09 KK Liberty™, 07/09 KA Dodge Nitro™; Also fits JK Tailgate.

Replaces Part No.	Quantity	Model	Comment
87500	1	JK, KK, KA	Individual
87500K2	2	JK, KK, KA	2 Dr.
87500K3	3	JK, KK, KA	2 Dr. Plus Tailgate
87500K4	4	JK, KK, KA	4 Dr.
87500K5	5	JK, KK, KA	4 Dr. Plus Tailgate



Door Hinges

Stainless or Black Powder Coated Stainless.

Replaces Part No.	Model	Comments	Color	Door
488476	JK	2 Dr-4 Hinges	Stainless	Full or Half
488471	JK	4 Dr-8 Hinges	Stainless	Full or Half
488475	JK	2 Dr-4 Body Hinges	Stainless	Full or Half
488470	JK	4 Dr-8 Body Hinges	Stainless	Full or Half
488441	TJ	4 Hinges	Stainless	Full or Half
RT34094	TJ	4 Hinges	Black	Full or Half
488420	YJ	4 Hinges	Stainless	Full
RT34093	YJ	4 Hinges	Black	Full
488441	YJ	4 Hinges	Stainless	Half
RT34094	YJ	4 Hinges	Black	Half
488420	CJ5, 7, 8	4 Hinges	Stainless	Full or Half
RT34093	CJ5, 7, 8	4 Hinges	Black	Full or Half



Tailgate Hinges

Replaces Part No.	Model	Years	Color
488442**	YJ Wrangler	87-95	Stainless
488442B*	YJ Wrangler	87-95	Black
488459**	TJ Wrangler	97-06	Stainless
8404**	JK Wrangler	07-14	Stainless

*Includes: 1 Hinge

**Includes: 2 Hinges



Lower Tailgate Hinges

Replaces Part No.	Model	Years	Color
488419	CJ-7,8	76-86	Stainless



Lower Door Hinge Brackets

Replaces Part No.	Model	Years	Color
488407	CJ, TJ, YJ Wrangler	55-06	Stainless
RT34092	CJ, TJ, YJ Wrangler	55-06	Black



Hood Vent Covers

Replaces Part No.	Model	Years	Color
488472	JK Wrangler	07-14	Stainless



Hood Hinges

Replaces Part No.	Model	Years	Color
JKHSS*	JK Wrangler	07-14	Stainless
RT91002	JK Wrangler	07-14	Stainless
RT34057	TJ Wrangler	97-06	Stainless
RT34091	TJ Wrangler	97-06	Black

*Includes: 1 Footman Loop and 2 Hood Stops



Windshield Hinges

Replaces Part No.	Model	Years	Color
488493	TJ Wrangler	97/06	Stainless
488403	CJ, YJ Wrangler	76-95	Stainless
RT34096	CJ, YJ Wrangler	55-95	Black



Hood Catch Kits

The Following Items Are Sold Only In Pairs

Sets (2 of each) are also available, ask your salesperson.

Replaces Part No.	Model	Years	Color
TJHCSS	TJ Wrangler	97-06	Stainless
JKHCSS	JK Wrangler	07-14	Stainless
488401	CJ, YJ Wrangler	41-95	Stainless

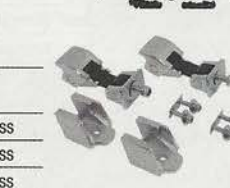

Complete Hood Sets

Replaces Part No.	Model	Years	Color
488477	JK Wrangler	07-14	Stainless



Tail Gate Stop

Replaces Part No.	Model	Years	Color
RT34015	YJ, CJ-7, 8	76-95	Stainless
RT26018	YJ, CJ-7, 8	76-95	Black



Windshield Tie Down Kits

Replaces Part No.	Model	Years	Color
488411	CJ-5, 6, 7, 8	55-86	Stainless
488411	YJ Wrangler	87-95	Stainless
488611	CJ-5, 6, 7, 8	55-86	Black
488611	YJ Wrangler	87-95	Black
72003	TJ Wrangler	97-06	Stainless



Mirror Relocation Brackets

Replaces Part No.	Model	Years	Color
57004	YJ Wrangler	87-95	Black
57005	TJ Wrangler	97-02	Black
488491	TJ Wrangler	97-02	Stainless
57006	TJ Wrangler	03-06	Black
MR1000	JK Wrangler	07-14	Black



Mirrors

Mirror Kits (Pair) Door Mounted

Set, 87-02 Style

Replaces Part No.	Model	Years	Color
82200834CK	YJ, TJ Wrangler	87-06	Chrome



Mirror Kits (Pair) Front Windshield Hinge Mounting

Set; Mounts to the front of the windshield hinge.

Replaces Part No.	Model	Years	Color
5751193STK	CJ-5, 6, 7, 8	55-86	Stainless
5751193STK	YJ Wrangler	87-95	Stainless



Mirror Kits (Pair) Side Windshield Hinge Mounting

Set; Mounts to the side of the windshield hinge.

Replaces Part No.	Model	Years	Color
57004	YJ Wrangler	87-95	Black
57005	TJ Wrangler	97-02	Black
488491	TJ Wrangler	97-02	Stainless
57006	TJ Wrangler	03-06	Black
MR1000	JK Wrangler	07-14	Black



Safari Mirror Kits

8"x6" Mirrors; Mounts directly to door hinge for use with doors off.

Replaces Part No.	Model	Years	Color	Comments
SDM100	CJ-5, 7, 8	76-86	Black	1 Mirror, 1 Arm and Hardware
SDM100K	CJ-5, 7, 8	76-86	Black	2 Mirrors, 2 Arms and Hardware
SDM100	JK, TJ, YJ Wrangler	87-14	Black	1 Mirror, 1 Arm and Hardware
SDM100K	JK, TJ, YJ Wrangler	87-15	Black	2 Mirrors, 2 Arms and Hardware.

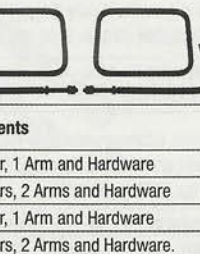

Quick Release Mirror Set

NEW

Set; Mounts to the side of the windshield hinge with thumb screw for quick release.

Replaces Part No.	Model	Years	Color
RT30020	JK, TJ, YJ Wrangler	87-95	Black
RT30020	CJ	76-86	Black



Crown Automotive Sales Co., Inc. and RT Off-Road are not affiliated with FCA US LLC. Part Numbers are used for reference purposes only. No implication is made that the actual products sold are the product of the original equipment manufacturer.

Jeep® is a registered trademark of FCA US LLC. More Applications Available.

JEEP® IN THE SHOP?

TRUST DORMAN OEM REPLACEMENT PARTS!



630430

Jeep 03-06, front right

AXLE SHAFT

Offering a complete line of Axle Shafts for a wide range of applications. All our Axle Shafts are constructed of high-quality steel for long-lasting durability.



800750

2.5, 4.0L 87-95

AUTO TRANS OIL COOLER LINE CONNECTOR

Constructed from high-quality materials to provide a leak-free connection between transmission lines or between the radiator and the transmission. Replacement restores the radiator to proper operation.



901410

99-01, front left

DOOR WINDOW SWITCH

Tested to ensure trouble-free installation and performance. Switches are designed to last. They're durable against water, debris, and constant use.



748912

07-11, front left

POWER WINDOW MOTOR AND REGULATOR ASSEMBLY

Re-engineered to improve on the original design. The latest technological advances in motors, materials and cable systems have been applied to new and previously released applications.



628301

Cherokee 94-96

AIR BAG CLOCKSPRING

Our Air Bag Clockspring repair solution allows you to replace just the failure prone clock spring not the whole assembly, saving hours of bay time. This re-engineered part allows technicians to safely and securely install a new clock spring into existing



615610

4.0L 99-04, upper

CLUTCH HYDRAULIC LINE

Thoroughly pressure-tested by a team of engineers to ensure quality and ease of replacement, all designed to fit properly. Plus, depending on the application, all necessary attachment hardware and release tools are included

ENGINE INTAKE MANIFOLD

Re-engineered using innovative plastic technology, our Engine Intake Manifold is lighter than the original aluminum design - and easier to install. Since this part is a direct replacement, the exact fit adds another layer of efficiency and con

DORMAN®



Our Power Brands Set the Standard

No other parts manufacturer comes close to matching Federal-Mogul Corporation's portfolio of power brands in terms of reputation and loyalty among customers. Our replacement parts are used in underhood, undercar and other applications in millions of cars, light trucks and commercial vehicles on every continent.



Hub Assemblies

New from Federal-Mogul, the Quick Steer line of hub assemblies is an affordable alternative that covers 95% of all applications while providing quality product at an affordable price.



Hub Assemblies

- Superior oil seal
- OEM-approved bearing design
- OEM ABS sensor and plug
- Precision-matched components
- Post-assembly quality assurance testing
- Engineered for seamless systems operation



Ball Joints

The design and engineering features of Federal-Mogul's MOOG® ball joints ensure that our products will deliver the performance and durability necessary to meet the demanding needs of our customers. The ball-joint housings are forged and/or machined from a single block of fine-grain alloy steel, providing unequaled strength and durability.



Tie Rods

Federal-Mogul's MOOG® brand tie rods feature a patented cover-plate design that captures the full-ball stud between the upper and lower bearings, eliminating axial clearance or "lash." This design consistently produces just the right amount of preload, providing proper steering effort over the life of the part.



Starters and Alternators

We provide alternators, starters, and electric and hybrid motors for the heavy-duty and light-duty original equipment markets, as well as new and remanufactured alternators and starters to the aftermarket.

- Boasts the most compact designs in the industry
- These smaller and lighter components translate into less friction, greater reliability and better performance
- Results in great speed, increased torque and maximum power on the open road
- 100% New premium quality components
- Manufactured to meet and or exceed OEM specifications



National[®] Oil Seals & Bearings

Federal-Mogul's National product line offers extensive coverage of antifriction bearing products for every automotive and heavy-duty wheel end configuration, including:

- Single- and double-row sealed bearings (front and rear wheel)
- Cylindrical roller bearings for semi-floating axle (rear wheel)
- Inner and outer tapered roller bearings for full-floating axle (rear wheel)
- Heavy-duty tapered roller bearings (steer, drive and trailer axles)
- Spindle bearing and inner and outer wheel bearings (front axle/4WD)



Miniature Bulbs

- Wagner offers miniature lamps for turn signals, brake lamps, taillights, and interiors, as well as daytime running lamps
- Federal-Mogul manufactures Wagner miniature lamps with a continuous coil that resists shock and vibration, extending service life. This design also improves candlepower consistency. In addition, we use high-temperature gas so the lamps can be used in the hottest-running applications
- Wagner miniature lamps are built to original equipment specifications



FEDERAL MOGUL

We Make the Brands the World Respects

No other manufacturer in the world has more knowledge about automotive steering solutions than Federal-Mogul. We have decades of experience in initial design and production of steering and suspension components for original equipment manufacturers, coupled with a depth of experience in product replacement in the aftermarket. Our products are precisely made from quality materials, and built with an eye to value.

FEL-PRO

Intake Manifold Gaskets

Leaks at the intake manifold allow too much air to enter the engine, creating problems such as rough idling and stumbling on acceleration. Federal-Mogul's Fel-Pro intake manifold gaskets are made of a rubber or fiber facing over a steel core, use the Fel-Pro PermaTorque® design. Fel-Pro also offer PermaDryPlus® intake manifold gaskets designed specifically to address tough sealing issues and to help ensure a tight seal and prevent leaks.

MS Series



Exhaust Manifold Gaskets

Many new engines do not come equipped with exhaust manifold gaskets. Because the castings are new and machined surfaces are smooth, the manifold fits tightly against the cylinder head without leaks. However, prolonged use, high exhaust temperatures, and numerous heating and cooling cycles can cause the manifold sealing surfaces to warp and corrode, leading to leaks. Federal-Mogul offers exhaust manifold gaskets designed and constructed specifically for this situation.

MS Series

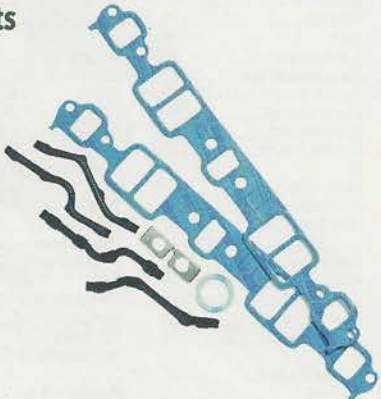

TI Automotive

Fuel Pumps and Components

Walbro is the world's largest manufacturer of carburetors and a major manufacturer of ignition systems, fuel injection and air/fuel management components, and fuel storage and delivery components for engines targeted at outdoor power equipment, marine, recreational and two-wheel applications.



NEW

WAGNER OEX

provide patent-pending, customized braking designs for pickups, SUVs and CUVs that consistently deliver optimal stopping performance in all conditions. It allows you to stop up to 50' sooner based on benchmark testing.*

*Results based on 60 MPH post fade performance testing conducted by Link Engineering Company comparing Wagner Brake pads to competitor's brake pads on the 2014 Ford F-150, 2011 Toyota RAV4 and 2013 Chevrolet Tahoe



WAGNER THERMO QUIET Brake Pads

Wagner ThermoQuiet CeramicNXT brake pads feature: Patented IMI one-piece brake pad provides maximum noise damping and dissipates heat generated during braking

- Laser-Shaped Friction technology custom shapes friction to focus caliper force further reducing vibration and eliminating noise
- Comprehensive coverage for foreign and domestic applications - passenger cars, light trucks, SUVs and mini-vans
- OE match friction material - semi-metallic, organic, and ceramic (ceramic alternatives available for select semi-metallic applications)
- Optimal performance - engineered to pass OE manufacturer-developed stopping tests



CHAMPION

Double Platinum Power Spark Plugs

Platinum on both the center and ground electrodes provides longer life and minimal wear. In addition, Champion's fine-wire and V-trimmed electrodes create sharper spark focus than conventional plugs. The electrodes on these plugs use our exclusive Heat-Active™ alloy to reach operating temperatures quickly and maintain stable operating temperatures under varying engine loads.



MANUFACTURER

A
 Accel 116, 129
 AEM Electronics 118, 131
 133
 aFe 117, 118, 133
 Airaid 118
 American Racing 26
 Anzo 81, 82, 83
 88
 ARB 14, 45, 51, 62
 65, 78, 87, 119
 133, 134
 Atlas 41
 Atturo 30
 ATX Wheels 26
 Auto Meter 127
 AVS 103, 104

B
 B&M 135
 Banks 118, 124
 BD Diesel 117
 BedRug 106
 Bestop 36, 76
 90-94, 98, 107
 Bilstein 21
 Black Mountain 18, 25, 34
 99, 102, 105
 Body Armor 48
 BOLT 70
 Borgeson 137
 Borla 123
 Bosch 128
 Bubba Rope 64
 Bully Dog 117
 Bushwacker 32, 52

C
 Centerforce 135
 Champion 147
 Atpm Cams 131
 Corsa 124
 Covercraft 109
 Coverking 110
 Crown Automotive 34
 139, 140

D
 Daystar 16, 66, 77
 88, 102
 Delta 89
 DENSO 128
 Derale 130
 DiabloSport 116
 Dick Cepek 26, 29
 Dorman 145
 Drake 108
 Draw-Tite 69, 70
 Dynamax 124

E
 Eaton 138
 EBC Brakes 132
 Edelbrock 126
 EGR 54, 104
 Energy Suspension 22, 66
 131
 Evans Cooling 130
 Extreme Dimensions 102

F
 Fab Fours 46
 Fabtech 4, 5, 22, 23
 Factor 55 64
 Federal Mogul 146, 147
 Fel-Pro Gaskets 147
 Fla 110
 Flex-a-lite 130
 Flowmaster 125
 Flow Tech 125
 Fox Shocks 19
 FX Wheels 26
 Full-Traction Suspension 6

G
 G2 Axle & Gear 133
 Gibson Exhaust 124
 Go Industries 49
 Go Rhino 47, 54
 Grant Products 111

H
 Hanson Off Road 33, 35
 Hawk Performance 132
 Haynes Manuals 131
 Hellwig 18
 Hi-Lift Jack 67
 Holley
 Performance Products 131
 Husky Liners 112
 Hypertech 116

I
 IPCW 82, 83

J
 Jet Performance 117
 JKS Manufacturing 13

K
 K&N Filters 120, 121
 Kargomaster 72-73
 KC HILITES 80, 82, 83, 87
 KEEPER 66

L
 LRG Wheels 25
 Lucas Oil 134
 LUND 34, 54
 103, 110

M
 Magnaflow 122, 125
 MBRP 51, 114
 MGP Caliper Covers 132
 Mickey Thompson 27, 28
 49
 Mile Marker 59, 68
 Mishimoto 130
 MOOG 146
 Monroe 22
 Mountain Off-Road
 Enterprises 109, 129
 Motive Gear 136
 MSD Ignition 129

N
 National Seals 146
 N-FAB 51

O
 Off-Camber Fabrications 123
 Old Man Emu 14
 OneSource 146
 Optima Battery 128
 OR-Fab 42, 43
 Owens 54, 102

P
 Pacesetter 125
 Painless Performance
 Products 127, 130
 Pavement Ends 94
 Performance Automotive
 Group 15
 Pertronix 129
 PIAA 80
 Pilot Automotive 82, 83
 105
 Pop & Lock 81
 Powermaster 128
 Power Stop 132
 Powertrax/Lock Right 138
 Pro Comp 7, 20, 23, 24,
 30, 84
 PUREJEEP 35
 Putco 81, 83, 88, 99

Q
 Quarantine Restraints 65

R
 Rampage 49, 54, 76
 83, 97, 98, 100
 101, 105, 107
 Rancho 12, 20, 50
 RBP 34
 ReadyLIFT 2, 3
 Red Line Oil 134
 Remy 146
 Richmond Gear 137
 Rigid Industries 79, 84
 85, 88
 Royal Purple 134
 RT Off-Road 141-144
 Rubicon 10, 11, 23
 Rugged Ridge 23, 25, 33
 75, 77, 88, 96
 100, 102, 104
 113, 119, 133

S
 Skyjacker 8, 9, 20, 23
 Smittybilt 33, 40, 41
 60, 65, 88
 95, 98, 111
 Spidertrax 31
 SPEC Clutch 135
 Stampede 104
 SuperSprings 18
 Superchips 115
 Superior Axle & Gear 137
 Superwinch 60, 68
 Surco 71

T
 T-Rex 105
 Taylor Cable 128
 TeraFlex 1, 23, 51, 78
 100, 132, 133
 Thule 74
 TI Automotive 147
 Timbren 18
 Tow Ready 70
 TrailFX 18, 44, 53
 58, 86, 88
 Trans Dapt 131, 133
 Tuff Country 17

U
 Ultra Wheel 26, 27
 UnderCover 105

V
 Vertically Driven
 Products 75, 95
 VIAIR 62
 Vibrant 130
 Vision X 83, 88
 Volant 119

W
 Wagner Lighting 146, 147
 WARN 38, 39, 55-57
 63, 68, 79, 149
 WeatherTech 104, 113
 Westin 34, 37, 49, 53
 54, 61, 86, 103

WORX 27

X
 XD KMC 26, 27

Xenon 33

Y
 Yakima 72

Jeep® is a registered trademark of FCA US LLC. • The publishers are not responsible for typographical errors • Copyright ©2016. All rights reserved. All text, graphics, pictures, logos, and the selection and arrangement thereof is the exclusive property of the Publisher, or its content supplier. No portion of this publication, including images, may be copied or reproduced in any form without the prior written consent of the Publisher. Vehicles are sold separately.

PRODUCT

A
 Air Compressors 62
 134
 Air Compressor
 Accessories 62
 Air Filters 121
 Airlocker 134
 Alternators 146
 Antennas 108
 Axle Kits 133, 137, 145

B
 Ball Joints 141, 146
 Ball Mounts 70
 Batteries 128
 Battery
 Relocation Kits 128
 Battery Tray 128
 Bearing Kits 136, 139
 146
 Bike/Ski/Watersport
 Carriers 72, 74
 Bikini Tops 93
 Body Mount Kits 139
 Body Protection 40, 41, 43
 52
 Brake Kits 132, 142
 Brake Lines 11, 50, 142
 Brake Pads 132, 147
 Bug Shield 103
 Bumpers 35-42, 44-51
 53, 114
 Bump Stops 11

C
 Caliper Covers 132
 Cam and Lifter Kits 131
 Camping Accessories 78
 Carburetors 131
 Cargo Bags 75
 Cargo Carriers 71-74
 Cargo Covers 77
 Cargo Liners 109, 112
 113
 Cargo Racks 35, 44
 48, 71, 73, 76
 Cargo Rack
 Accessories 71, 72, 75
 Chrome Trim 99
 Clockspring 145
 Clinometers 108
 Clutches 135
 Coils 129
 Coil Spacers 13
 Consoles/Storage 75-77
 Control Arms 11, 13, 139
 Conversion Kit 100
 Cup Holders 108
 Cylinder Heads 126

D
 Dash Panels 77
 Differentials 138
 Differential Covers 50
 133, 141
 Distributors 129
 Doors 48, 50, 94
 Door Handles 144
 Door Locks 99
 Drawbar Kits 70

E
 Engine Coolant 130
 Exhaust
 Systems 122-125
 Exhaust Pipes 12

F
 Fans 130
 Fan Relays 130
 Fender Flares 32-34, 140
 Fittings 130
 Floor Liners/Mats 110
 112, 113
 Fog Lights 87
 Fridge/Freezer 78
 Fuel Doors 99, 100
 Fuel Pumps 131, 147

G
 Gap Guards 15
 Gas Covers 100
 Gaskets 147
 Gauges 127
 Gauge Pods 127
 Gear Oil 134
 Grab Handles 108, 110
 Grilles 143
 104, 105

H
 Hard Top Accessories 98
 Hard Top Carriers 71, 98
 Headers 123-125, 142
 Headlights 83, 84
 Hinges 144
 Hitches 69
 Hitch Balls 70
 Hood Kits 101, 102
 Hood Latches 100, 101
 Hood Protectors 52
 Hood Shields 103, 104
 Hood Vents 102
 Horn Buttons 111
 Hubs 68
 Hub Assemblies 146

I
 Intakes 118-120, 145
 Interior
 Accessories 106-113, 143

J
 Jacks 67
 Jack Accessories 66-67
 70
 Joint Repair Kits 140

L
 Leaf Springs 139
 LED Kits 80, 83, 85, 87
 Leveling Kits 1, 16, 18
 Lift Kits 3, 8, 15, 16, 17
 Light Bars 79-81
 84, 86-88
 Light Bulbs 146
 Light Covers 86
 Light Guards 99, 101
 Lighting 79-89, 142
 Lighting Mounts 43, 88
 89, 114
 Liners 106
 Locks 70

M
 Mirrors 100, 144
 Mirror Brackets 42, 100
 Mufflers 125

O
 Oil Filters 121
 Oil Filter
 Relocation Kits 131

P
 Pedals 109
 Pet Barriers 76
 Pitman Arms 17, 23
 Programmers 115-117

R
 Radiators 130
 Ramps 65
 Recovery
 Accessories 59, 62, 65
 66, 143
 Recovery Rope 64
 Repair Manuals 131
 Replacement
 Parts 139-146
 Replacement Tops 92, 97
 Restraint System 65
 Ring and Pinions 133
 136, 137
 Ring and Pinion
 Installation Kits 137
 Rock Rails/Sliders 39, 42
 45, 48
 Rocker Guards 35, 43, 44
 53

Rocker Panels 52
 Roll Bar Accessories 111
 Running Boards 47

S
 Seats 107, 108
 Seat Covers 107, 109-111
 Seat Hardware 107
 Shackles 141
 Shackle Mounts 64
 Shifters 135
 Shocks 3, 14, 19-22
 Side Armor 44
 Side Steps 53
 Skid Plates 35, 38, 51, 52
 Sleeving 127
 Snorkel Systems 119
 Soft Tops 90, 91, 94-97
 Soft Top
 Accessories 90
 Spacer Lift Kits 141
 Spark Plugs 75, 128
 147
 Spark Plug Wires 129
 Starters 128, 146
 Steering Kits 2, 141
 Steering Shafts 137, 139
 Steering Stabilizers 14, 18
 23
 Steering Wheels 111
 Steering Wheel
 Installation Kit 111
 Steps 47, 51, 53
 54, 109
 Straps 65, 66
 Superchargers 126
 Suspension
 Components 1, 6, 8, 13
 18, 23
 Suspension
 Enhancement Systems 18
 Suspension Systems 1-15
 18, 22
 Sway Bar Disconnects 23
 Switches 127

T
 Tailgate Covers 111
 Tailgate Mats 106
 Taillights 82
 Taillight Guards 44
 Tents 78
 Thermostats 130
 Throttle Body Spacers 118
 Tie Rods 146
 Tires 28, 29, 30
 Tire Carriers 39, 40, 43-44
 46, 50-51, 72
 Tow Bars 69
 Tow Bar Baseplates 69
 Track Bars 1, 2, 13, 23
 Transmission Mounts 131
 Trim 108
 Tube Fenders 33, 35
 Tune Up Kits 140
 Tuners 116, 117

V
 Vacuum Pump Kit 43

W
 Wheels 24-27
 Wheel Spacers 31, 143
 Winches 55-61
 Winch Accessories 56, 58
 59-61, 63-65
 Winch Mounts 35, 39
 Window Storage Bag 90, 98
 Window Switches 145
 Window Visors 103, 104
 Windshield Channels 94
 95, 97
 Windshield Hinges 100
 101, 144
 Wiper Blades 101
 Wiring Harnesses/Kits 69

SEE THESE CATALOGS FOR MORE PRODUCTS!

These Titles Also Available...

Ford • Dodge • Toyota • Chevy • Serious Performance
 Street Performance • Sport Compact Performance





READY FOR ANYTHING!

ZEON Platinum™ **Ultimate Performance, Advanced Technology** *Now available in 12k Synthetic*



Double The Durability.

The ultimate insurance policy on the trail or jobsite. ZEON Platinum tested TWICE as durable as the previous generation of winches.

New Spydura Pro™ Synthetic Rope.

Heat treated construction for maximum tensile strength, and compacted diameter prevents sand and dirt penetration.

High Performance Package.

Features a new high-performance motor for efficient amp draw and fast line speed, a stronger gear train, and high-strength sleeve-in-drum brake design.

IP68 Waterproof Rating.

See page 55 for all ZEON™ Winches.

What's Inside

*Exhaust ♦ Lighting ♦ Body Protection ♦ Wheels & Tires
Recovery ♦ Suspension ♦ Towing & Cargo ♦ Performance
Interior & Exterior Accessories Plus More!*



#16JEEP



880268135566